

brother®



PE-DESIGN PERSONAL EMBROIDERY DESIGN SOFTWARE SYSTEM **Instruction Manual** NEXT



IMPORTANT INFORMATION: REGULATIONS

Federal Communications Commissions (FCC) Declaration of Conformity (For USA Only)

Responsible Party: Brother International Corporation
100 Somerset Corporate Boulevard
Bridgewater, NJ 08807-0911 USA

declares that the product

Product Name: Brother USB Writer
Model Number: PE-Design

complies with Part 15 of the FCC Rules. Operation is subject to the following two conditions: (1) this device may not cause harmful interference, and (2) this device must accept any interference received, including interference that may cause undesired operation.

This equipment has been tested and found to comply with the limits for Class B digital device, pursuant to Part 15 of the FCC Rules. These limits are designed to provide reasonable protection against harmful interference in a residential installation. This equipment generates, uses, and can radiate radio frequency energy and, if not installed and used in accordance with the instructions, may cause harmful interference to radio communications. However, there is no guarantee that interference will not occur in a particular installation. If this equipment does cause harmful interference to radio or television reception, which can be determined by turning the equipment off and on, the user is encouraged to try to correct the interference by one or more of the following measures:

- Reorient or relocate the receiving antenna.
- Increase the separation between the equipment and receiver.
- Consult the dealer or an experienced radio/TV technician for help.
- Changes or modifications not expressly approved by the manufacturer or local sales distributor could void the user's authority to operate the equipment.

Canadian Department of Communications Compliance Statement (For Canada Only)

This Class B digital apparatus complies with Canadian ICES-003.

Radio Interference (Other than USA and Canada)

This machine complies with EN55022 (CISPR Publication 22) /Class B.

Congratulations on choosing our product!

Thank you very much for purchasing our product. To obtain the best performance from this unit and to ensure safe and correct operation, please read this Instruction Manual carefully, and then keep it in a safe place together with your warranty.

Please read before using this product

For designing beautiful embroidery designs

- This system allows you to create a wide variety of embroidery designs and supports a wider range of sewing attribute settings (thread density, sewing pitch, etc.). However, the final result will depend on your particular sewing machine model. We recommend that you make a trial sewing sample with your sewing data before sewing on the final material.

For safe operation

- Avoid dropping a needle, a piece of wire or other metallic objects into the unit or into the card slot.
- Do not store anything on the unit.

For a longer service life

- When storing the unit, avoid direct sunlight and high humidity locations. Do not store the unit close to a heater, iron or other hot objects.
- Do not spill water or other liquids on the unit or cards.
- Do not drop or hit the unit.

For repairs or adjustments

- In the event that a malfunction occurs or adjustment is required, please consult your nearest service center.

Notice

Neither this Instruction Manual nor the Installation Guide explains how to use your computer under Windows[®]. Please refer to the Windows[®] manuals.

Copyright acknowledgment

Windows[®] is a registered trademark of Microsoft Corporation. Other product names mentioned in the Instruction Manual and Installation Guide may be trademarks of registered trademarks of their respective companies and are hereby acknowledged.

Important

Using this unit for unauthorized copying of material from embroidery cards, newspapers and magazines for commercial purpose is an infringement of copyrights which is punishable by law.

Caution

The software included with this product is protected by copyright laws. This software can be used or copied only in accordance with the copyright laws.

SAVE THESE INSTRUCTIONS
This product is intended for household use.

For additional product information and updates, visit our web site at:
<http://www.brother.com/> or <http://solutions.brother.com/>

Turn Any Design Into Original Embroidery With PE-DESIGN



This software provides digitizing and editing capabilities, allowing you the creative freedom to design original embroidery. Easily turn illustrations, photos and lettering into custom embroidery designs.

Improved User Interface for Better Operability

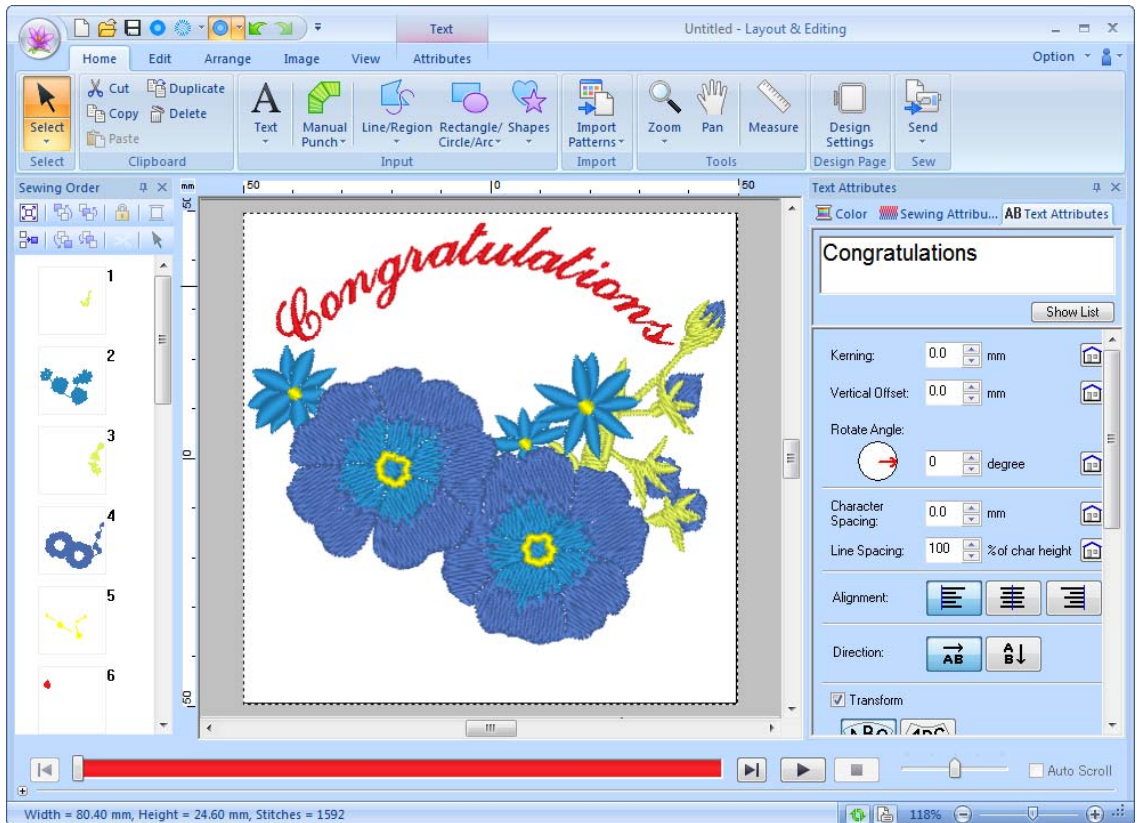

- The **Ribbon** is an area in each application window that displays related commands.
- The **Application** button displays a menu containing commands for the most important file operations, such as **Save**.
- **Realistic View** allows you to edit the embroidery pattern while viewing a realistic image of the embroidery.
- The **Color/Sewing Attributes/Text Attributes** pane provides easy access to even the more detailed settings.
- The **Sewing Order** pane allows you to monitor the sewing order of the patterns.
- **Floating, Docking** and **Auto Hide** allow you to display only the panes and dialog boxes containing the information that you need.
- **Stitch Simulator** provides quick access to a simulation of the embroidering.

New Stitching Features for More Expressive Embroidery

■ Stem Stitch and Candlewicking Stitch (☞ p. 293, p. 298)



■ Floral Pattern

(☞ p. 47)

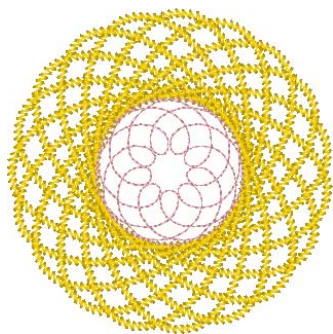

■ Offset Line

(☞ p. 49)



■ Mirror Copy

(☞ p. 53)

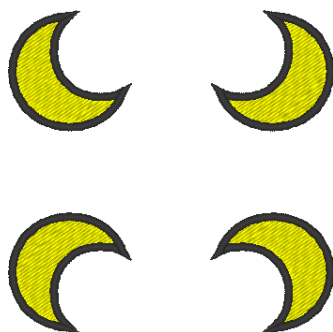

■ Circle Copy

(☞ p. 53)

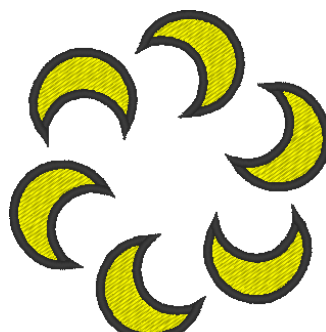

Enhanced Lettering Features

■ 100 built-in fonts (p. 310)



■ Name Drop feature (p. 107)



Easily create a number of similar embroidery designs by simply replacing text, such as a name, arranged within the pattern.

■ Outline sewing (p. 101)

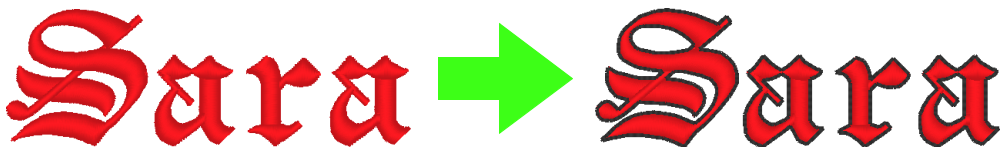

Easily add an outline around letters.

Key PE-DESIGN Functions That Allow You To Create Beautiful Embroidery Designs

■ Print and Stitch

(p. 142)



■ Blending

(p. 44)



■ Automatically convert images to embroidery designs (p. 118)

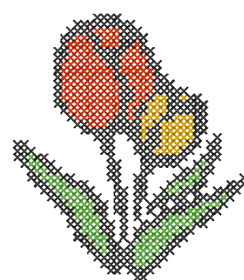
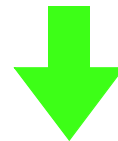
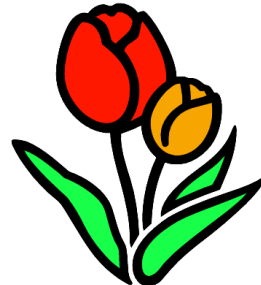

Various Tools for Maximizing Your Creativity

Design Center

(p. 183)

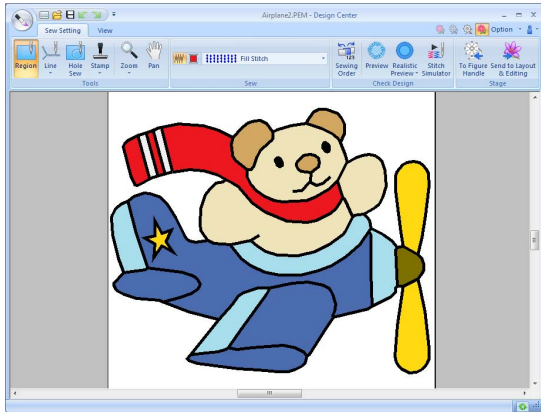

The outline of an image can be extracted to manually create an embroidery pattern. The shapes of lines and regions can be edited, and the stitches and colors of even minute areas can be specified.

Design Database

(p. 211)

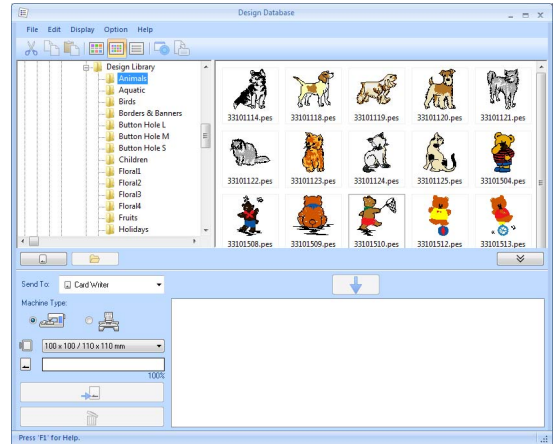

View design images of the embroidery data being managed. In addition, searches and format conversions can be performed.

Programmable Stitch Creator

(p. 229)

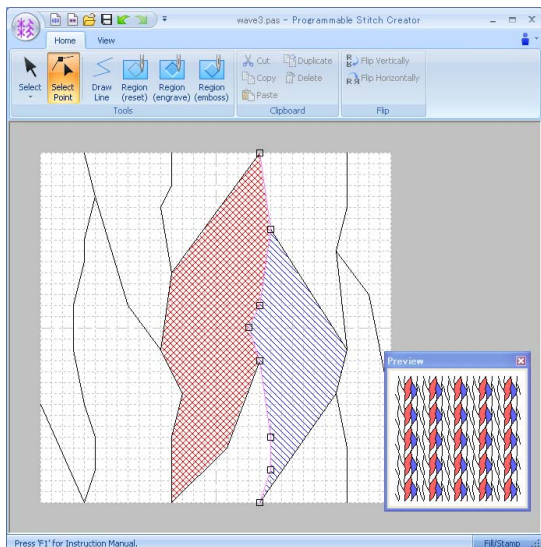

Simply changing the stitch in a pattern can give it a completely different feel. Stitch patterns can be designed to create dramatic embroidery.

Font Creator

(p. 245)

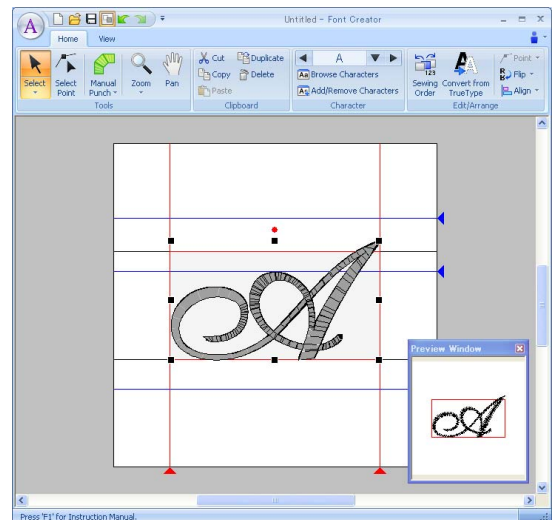

Original fonts can be created. Save hand-written characters to embroider lettering designs in your own handwriting.

Link Function Meets Small Business Needs

Embroidery designs can be sent from the computer to be embroidered on multiple embroidery machines. From the computer, you can select which embroidery machine will sew which embroidery design, and the data can be transferred to the machine. While the design is being embroidered, the status of each machine can be monitored from the computer.

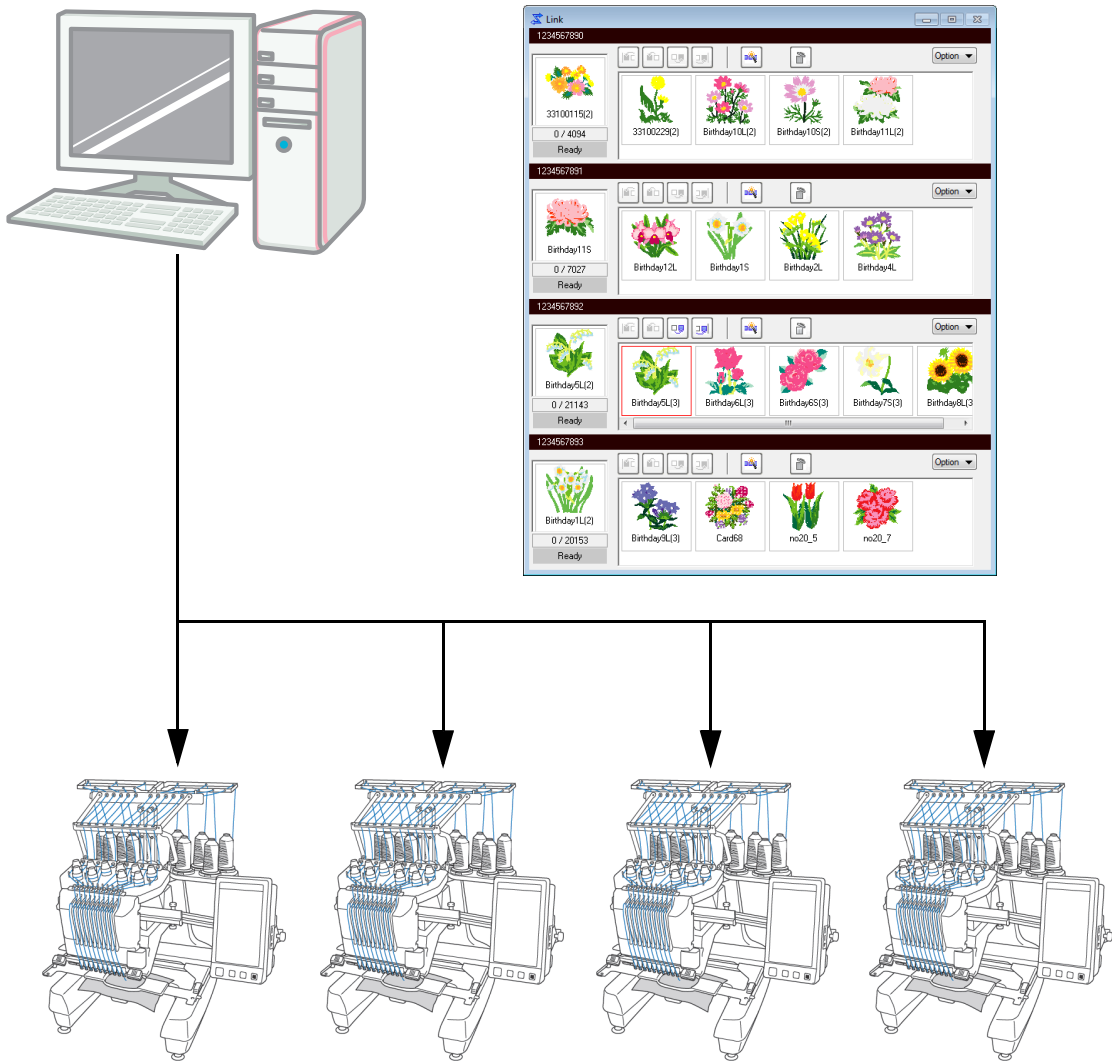

Note:

The Link function is designed specifically for our compatible embroidery machines. Refer to the Operation Manual for the embroidery machine to determine if it is compatible with this function.

New Features of PE-DESIGN NEXT

■ The name of each application is abbreviated as shown below.

LE:	Layout & Editing	DC:	Design Center
FC:	Font Creator	PSC:	Programmable Stitch Creator
DB:	Design Database		

■ Enhanced Functions for Creating Stitching Variations

- The stitching variations available for line sewing (Line sew type) has been increased. **LE** (☞p. 298)
 - Stem stitch
 - Candlewicking stitch
- The **Create Floral Pattern** command has been added. This command can be used to create floral patterns by drawing spirals based on the selected shape. **LE** (☞p. 47)
- The **Mirror Copy** and **Circle Copy** commands have been added. These commands create patterns using horizontal/vertical mirror copies (**Mirror Copy**) or copies of the selected pattern arranged on a circle (**Circle Copy**). **LE** (☞p. 53)
- The **Create Offset Lines** command has been added. This command allows any number of offset lines to be drawn inside or outside of a pattern. **LE** (☞p. 49)
- The **Decorative Pattern** command has been added. With this command, a pattern that surrounds a selected object can easily be added. **LE** (☞p. 54)
- The **Import from Vector Image** command has been added. With this command, a data file in the vector format (WMF) can simply be converted to embroidery data. **LE** (☞p. 79)
- The **Offset** attribute has been added for motif stitch patterns. By using the **Offset** attribute to change the reference position for arranging patterns, many more variations of the motif stitch can be created. **LE** (☞p. 297, p. 307)
- The default size for creating patterns with Motif Stitch and Prog. Fill Stitch can be specified. This allows a pattern to be created while considering the size. **PSC** (☞p. 243)
- A motif stitch in line sewing can be set so that motifs are not sewn twice, even when the start and end points are moved. **LE** (☞p. 300)
- By combining outlines and shapes, embossing/engraving effects can easily be created. **LE** (☞p. 59)
- Functions in the Image to Stitch Wizard have been improved. **LE**
 - Mask settings and the image size and position can be changed when **Auto Punch** or **Cross Stitch** are selected in the wizard. (☞p. 120, p. 130)
 - A stitching frame along the outline of the mask selected in the wizard can be outputted. (☞p. 121, p. 133)
 - The stitch angle can be specified when **Photo Stitch 2** is selected. (☞p. 129)
- The Template function was added. By simply replacing text in previously designed embroidery templates, customized embroidery designs can be created. **LE** (☞p. 113)

■ Improved User Interface Is Easier To Use

- A ribbon has been incorporated into the advanced user interface. The ribbon allows users to easily find the necessary functions and enables more intuitive operation. (**LE,DC,FC,PSC**) (☞p. 19, p. 278)

- Editing is possible in Realistic View. The pattern can be edited while being displayed as a realistic image of the actual embroidery (Realistic View). **LE** (☞p. 70)
- Stitch Simulator has been improved. **LE** (☞p. 71)
 - A stitch simulation can be viewed at any time while the pattern is being edited.
 - The stitch simulation can also be viewed while the pattern is displayed in Realistic View.
 - The embroidering progress, such as how the colors appear, can easily be seen.
 - The window can be scrolled while stitching is being simulated.
 - The simulation commands can be switched between a compact view and a more detailed view.
- The Sewing Order pane has been improved. The pane is arranged in an easy-to-use vertical layout and can be docked at the side of the window. **LE** (☞p. 19)
- A Pan tool has been added. You can scroll through the pattern by simply dragging the Design Page. **(LE,DC,FC)** (☞p. 69)
- The Zoom commands have been improved.
 - A Zoom slider has been added to the status bar. **LE** (☞p. 20)
 - Right-click with the Zoom In tool to zoom out. **LE** (☞p. 69)
- Functions for editing thread colors have been improved.
 - Thread colors can easily be selected from the list of colors used in the current design at the bottom of the Color pane. **LE** (☞p. 57)
 - Thread colors of stitch data can be changed with the Select tool. **LE** (☞p. 66)
- Basic editing operations have been improved.
 - A duplicate of a pattern can easily be created at a specified location. A duplicate of a pattern can be created by holding down the **Ctrl** key and dragging a pattern selected with the Select tool. **(LE,DC,FC,PSC)** (☞p. 34)
 - The functions for rotating have been improved. When a pattern is selected, a rotation handle appears. **(LE,DC,FC,PSC)** (☞p. 52)
 - The pattern outline is drawn while the pattern is being resized, moved or rotated. **LE** (☞p. 52)
- Buttons for selecting the next or previous character have been added to Font Creator. **FC** (☞p. 256)
- More settings for changing the appearance of the application have been added to the **Options** dialog box. (☞p. 273)
 - Customize: Commands can be added to or removed from the Quick Access Toolbar in the title bar. In addition, shortcut keys can be changed. **(LE,DC,FC,PSC)**
 - DST Settings: By specifying the number of jumps for thread trimming under **DST Import Setting**, the information for thread trimming locations can also be converted correctly when DST files are imported. **LE**
 - Screen Calibration: By correctly specifying the Screen Calibration setting, designs can be displayed adjusted to the actual size with a zoom ratio of 100%. **LE**

■ Enhanced Lettering Functions

- Font/character variations have been increased. **LE** (☞p. 310)
 - The number of built-in fonts has been increased to 100 fonts.
 - The number of symbols and accented characters has been increased.
- Line sewing can also be specified for built-in fonts. **LE** (☞p. 101)

- The user interface for selecting the font has been improved. **LE** (☞p. 93)
 - A history of fonts that have been selected appears in the **Font** selector.
 - If text is selected when the **Font** selector is clicked, the selected text appears as the sample for each font.
- The positions for connection points between letters within the same text (end point of one letter and the start point of the next letter) can be specified. Select the setting for creating stitching that reduces the number of times the thread must be trimmed (**Closest**), the setting for creating stitching so that the thread can easily be cut by hand (**Farther**), or the setting for creating stitching for a better overall quality of the text (**Default**). **LE** (☞p. 100)
- The Name Drop function was added to be used with text. With the Name Drop feature, you can easily create a number of similar embroidery patterns, for example, for uniforms, by replacing only the name in the pattern. **LE** (☞p. 111)
- The user interface for entering and editing text has been improved. **LE**
 - Simply select a Text tool and click in the Design Page to directly enter text into it. (☞p. 92)
 - While text is selected, either the entire text or individual characters can be edited using the Select tool. (☞p. 97)
 - The arc shapes available under **Transform** in the **Text Attributes** tab can easily be modified. (☞p. 91)
 - Using simple dragging operations, character attributes, such as kerning and character size, can be modified for individual characters in text with the **Transform** attribute applied. (☞p. 95)
- The **Convert to Block** command was added for text. This allows text patterns to be converted to manual punching block patterns, so that the shape of characters can be customized. **LE** (☞p. 99)

■ Enhanced Features for Collaborating With Our Embroidery Machines

- The functions for transferring data to embroidery machines have been enhanced. (**LE,DB**) (☞p. 174, p. 217)
 - Various methods are available for transferring data to embroidery machines: using USB media, a card writer or the Link function in addition to connecting directly to an embroidery machine via a USB cable.
 - The Link function allows data to be transferred from the application to an embroidery machine connected to the computer. Data can easily be transferred from the computer to the embroidery machine. (*Availability depends on the embroidery machine model.) (☞p. 177)
- More embroidery frame sizes are available from the **Design Settings** dialog box.
 - Split embroidery designs for embroidering with the jumbo frame (360 × 360 mm) can easily be created. (*Availability depends on the embroidery machine model.) **LE** (☞p. 166)
 - New types of embroidery frames (360 × 200 mm frame, round frames, jumbo frame, wide cap frame, etc.) are available from the **Hoop Size** selector on the **Design Page** tab of the **Design Settings** dialog box. (*Availability depends on the embroidery machine model.) (**LE,DC,DB**) (☞p. 85)
 - Any size hoop can be added to the **Hoop Size** selector on the **Design Page** tab of the **Design Settings** dialog box. **LE** (☞p. 86)
- A jump stitch thread trimming setting has been added. With this, detailed settings can be specified for switching on/off thread trimming at jump stitches between objects of the same color. (*Availability depends on the embroidery machine model.) **LE** (☞p. 75, p. 270)
- Images of embroidery designs can be printed in Catalog Style or Instruction Guide style. **DB** (☞p. 226)

Transferring Designs to the Embroidery Machine

The procedure for transferring an embroidery design to the machine differs depending on the embroidery machine.

Check your machine's specifications, and then select the appropriate transfer method.

This software supports four different methods for transferring data.

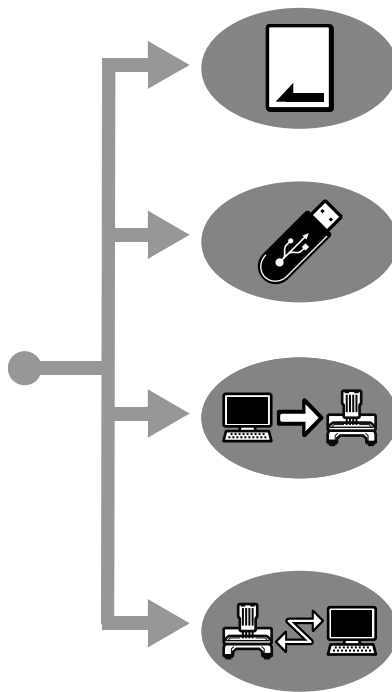

For embroidery machines compatible with embroidery cards

Use an original card.

( p. 174)

For embroidery machines compatible with USB media

Use commercially available USB media.

( p. 175)

For embroidery machines that can be connected to a computer using a USB cable

Transfer the embroidery design with the USB cable.

( p. 176)

For our embroidery machines compatible with the Link function

Use the Link function to transfer embroidery designs to the embroidery machine that was included with the machine.

( p. 177)

Memo:

- In order to use the Link function to transfer embroidery designs to an embroidery machine, a machine compatible with the Link function must be running in Link mode.
- In order to save embroidery designs in the memory of an embroidery machine, the machine must be running in normal mode.

Table of Contents

New Features of PE-DESIGN NEXT9

Table of Contents13

How To Use Manuals.....15

Support/Service16

- Online Registration..... 16
- Checking for the Latest Version of the
Program 17

Starting Up/Exiting Applications18

- Starting Up Application..... 18
- Exiting Applications 18

Understanding Windows19

- Layout & Editing Window 19
- Specifying Basic Software Settings.....22

Getting Started.....23

- Tutorial 1: Getting Started24

Basic Layout & Editing Operations.....31

- Tutorial 2: Drawing shapes to create an
embroidery design.....32
- Drawing Shapes39
- Editing Embroidery Designs50
- Applying Sewing Attributes to Lines and
Regions56
- Reshaping Embroidery Patterns62
- Editing a Stitch Pattern.....66
- Checking Embroidery Patterns69
- Opening/Importing Embroidery Designs77
- Saving and Printing81
- Specifying the Design Page Size and
Color.....85
- Changing Application Settings88

Creating Embroidery Patterns Containing Text89

- Tutorial 3: Entering text90
- Advanced Operations for Entering Text92
- Tutorial 4: Monograms.....103
- Advanced Operations for Entering
Monograms.....106
- Tutorial 5-1: Using Name Drop.....107
- Tutorial 5-2: Creating Name Drop109
- Name Drop Feature (Replacing Text)111
- Tutorial 5-3: Using Templates113
- Template Feature115

Creating Embroidery Patterns Using Images117

- Stitch Wizard: Automatically Converting an
Image to an Embroidery Design118
- Tutorial 6-1: Auto Punch.....119
- Auto Punch Features.....121
- Tutorial 6-2: Photo Stitch 1122
- Photo Stitch 1 Features125
- Tutorial 6-3: Photo Stitch 2127
- Photo Stitch 2 Features129
- Tutorial 6-4: Cross Stitch130
- Cross Stitch Features132
- Advanced Stitch Wizard Operations.....134
- Importing Image Data137
- Changing the Image Settings140
- Tutorial 7: Print and Stitch142

Operations for Specific Applications147

- Manually Creating Professional-Level
Embroidery Patterns (Manual Punching).....148
- Tutorial 8: Manual Punching.....149
- Tutorial 9: Creating Appliqués153
- Tutorial 10-1: Creating Split Embroidery
Designs.....155
- Tutorial 10-2: Creating Design for
Multi-Position Hoops.....161
- Tutorial 10-3: Embroidering With the Jumbo
Frame166
- Specifying/Saving Custom Sewing
Attributes170

Transferring Data 173

- Transferring Embroidery Designs to Machines174
- Using the Link Function to Embroider From the Computer.....177

Design Center..... 183

- Basic Design Center Operations184
- Design Center Window.....193
- Original Image Stage.....194
- Line Image Stage196
- Figure Handle Stage.....198
- Sew Setting Stage.....203

Design Database 211

- Design Database Window212
- Starting Up Design Database213
- Organizing Embroidery Designs.....214
- Opening Embroidery Designs.....216
- Transferring Embroidery Designs to Machines217
- Searching for an Embroidery Design.....222
- Converting Embroidery Design Files to Different Formats.....223
- Checking Embroidery Designs224
- Outputting a Catalog of Embroidery Designs.....226

Programmable Stitch Creator 229

- Basic Programmable Stitch Creator Operations230
- Creating Fill/Stamp Stitch Pattern231
- Editing a Pattern in Fill/Stamp Mode235
- Creating Motif Stitch Pattern.....237
- Editing a pattern in Motif Mode.....240
- Programmable Stitch Creator Window241
- Opening a Template242
- Preview window.....243
- Saving Patterns243
- Changing the Settings244

Font Creator 245

- Basic Font Creator Operations246
- Font Creator Window.....253
- Opening a File255
- Selecting a Character and Preparing the Template.....256
- Creating a Font Character Pattern258

- Editing the Points of a Font Character Pattern 260
- Checking the Created Font Patterns 261
- Saving Font Character Patterns 263
- Changing the Settings 264

Supplement 267

- Enlarging/Reducing Stitch Patterns 268
- Sewing Direction.....268
- Sewing Order.....269
- Sewing Wide Areas269
- Jump Stitch and Jump Stitch Trimming 270
- Fonts Suitable for Embroidering 271
- Converting Characters (Japanese, Chinese, Korean, etc) to Embroidery Patterns 272
- Changing the Appearance of the Application (Options).....273
- Troubleshooting 276

Menus/Tools and Reference 277

- Layout & Editing..... 278
- Design Center..... 284
- Design Database 287
- Programmable Stitch Creator 289
- Font Creator..... 291
- Sewing attributes 293
- Font List 310

Index..... 314

How To Use Manuals

The following manuals are included with this software.

Installation Guide

This guide contains instruction about the preparations necessary to begin using the software. Follow the instructions provided in this guide to complete the preparation and installation of the software.

Instruction Manual

This manual contains instruction on how to use the PE-DESIGN software.

First, read “Starting Up/Exiting Application”, “Understanding Windows” and “Specifying Basic Software Settings” to gain a general understanding of the basic software applications.

Next, read “Getting Started”. This chapter provides procedures for creating embroidery patterns as examples for performing basic Layout & Editing operations and transferring patterns to the embroidery machine. Follow the procedures to create actual embroidery patterns.

The chapters dedicated to each application provide descriptions of the useful functions and the various settings. Each descriptive title allows you to easily find the information that you need. In the chapters containing tutorials, follow the procedures to practice the various operations. Afterward, read the detailed descriptions.

Additional information is provided in the following chapters. Read the appropriate chapter when necessary.

Support/Service: Provides warranty information for this product in addition to the procedure for updating the software.

Supplement: Provides function introductions, details on the settings available in the **Options** dialog box and troubleshooting procedures in addition to tips and precautions to maximize the use of this software.

Menus/Tools and Reference: Provides lists of sew types, sewing attributes and fonts in addition to the various commands.

The procedures in this manual are written for use in Windows 7[®]. If this software is used on an operating system other than Windows 7[®], the procedures and appearance of the windows may differ slightly.

■ Opening the Instruction Manual (PDF format)

This manual is provided in a PDF format on the enclosed CD-ROM. The Instruction Manual is also installed during software installation.

Click **All Programs**, then **PE-DESIGN NEXT**, then **Instruction Manual**.

Otherwise, with any application other than Design Database, click , then **Instruction Manual**.

With Design Database, click **Help**, then **Instruction Manual**.



Memo:

- Adobe[®] Reader[®] is required for viewing and printing the PDF version of the Instruction Manual.
- If Adobe[®] Reader[®] is not on your computer, it must be installed. It can be downloaded from the Adobe Systems Incorporated Web site (<http://www.adobe.com/>).

Contact Technical Support if you have a problem. Please check the company web site (<http://www.brother.com/>) to find the Technical Support in your area. To view the FAQ and information for software updates, visit the Brother Solutions Center at (<http://solutions.brother.com/>).



Note:

- *Have the information ready before contacting Technical Support.*
 - *Make sure your computer's operating system is current with all updates.*
 - *Have the make and model of your computer and Windows® Operating System. (Refer to the Installation Guide for system requirements.)*
 - *Information on error messages that appear. This information will help expedite your questions more quickly.*
 - *Make sure PE-DESIGN NEXT is current with any updates.*

Online Registration

If you wish to be contacted about upgrades and provided with important information such as future product developments and improvements, you can register your product online by following a simple registration procedure.

Click  in Layout & Editing, then **Online Registration** to start up the installed Web browser and open the online registration page on our Web site.

The online registration page on the Web site appears when the following address is entered in the **Address** bar of the Web browser.

<http://www.brother.com/registration/>



Memo:

Online registration may not be available in some areas.

Checking for the Latest Version of the Program

Click  in Layout & Editing, then **Check for Updates**.

The software is checked to determine whether or not it is the latest version.

If the message shown below appears, the latest version of the software is being used.

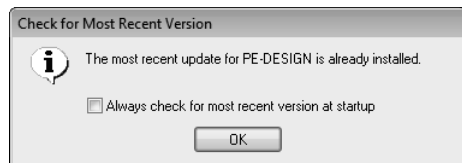

If the message shown below appears, the latest version of the software is not being used. Click **Yes**, and then download the latest version of the software from the Web site.

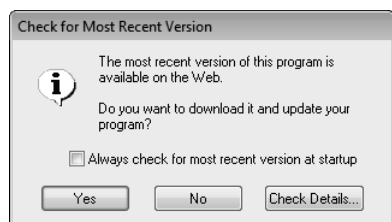

Memo:

*If the **Always check for most recent version at startup** check box is selected, the software is checked at startup to determine whether or not it is the latest version.*

→ The **User Account Control** dialog box appears.
Click **Yes**.



Starting Up Application

Layout & Editing

Click , then **All Programs**, then **PE-DESIGN NEXT**, and then click **PE-DESIGN NEXT (Layout & Editing)**.

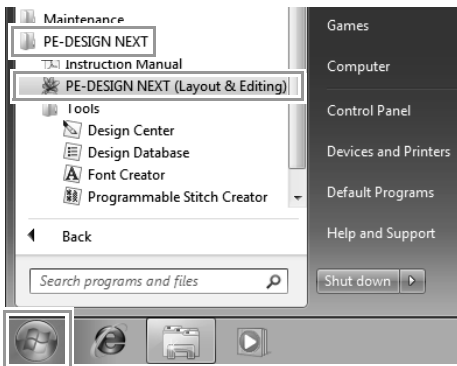

About the Top Wizard

When Layout & Editing starts up, the following wizard appears.

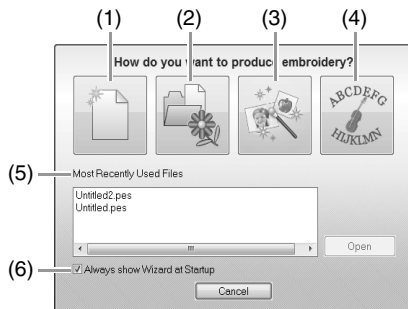

- (1) **New**
Click this button to begin creating a new pattern.
- (2) **Open PES**
Click this button to open embroidery data (.pes).

 *"Opening a Layout & Editing file" on page 77*

- (3) **Image To Stitch**

Click this button to start the wizard for creating an embroidery pattern from an image.

 *"Stitch Wizard: Automatically Converting an Image to an Embroidery Design" on page 118 and "Importing Image Data" on page 137*

- (4) **Template**

Click this button to start the Template wizard.

 *"Tutorial 5-3: Using Templates" on page 113*

- (5) **Most Recently Used Files**

Click the name of a file from the list, and then click **Open**.

- (6) **Always show Wizard at Startup**

Select this check box to start up the wizard each time Layout & Editing is started up.

Exiting Applications

Click , then **Exit**.



Layout & Editing Window

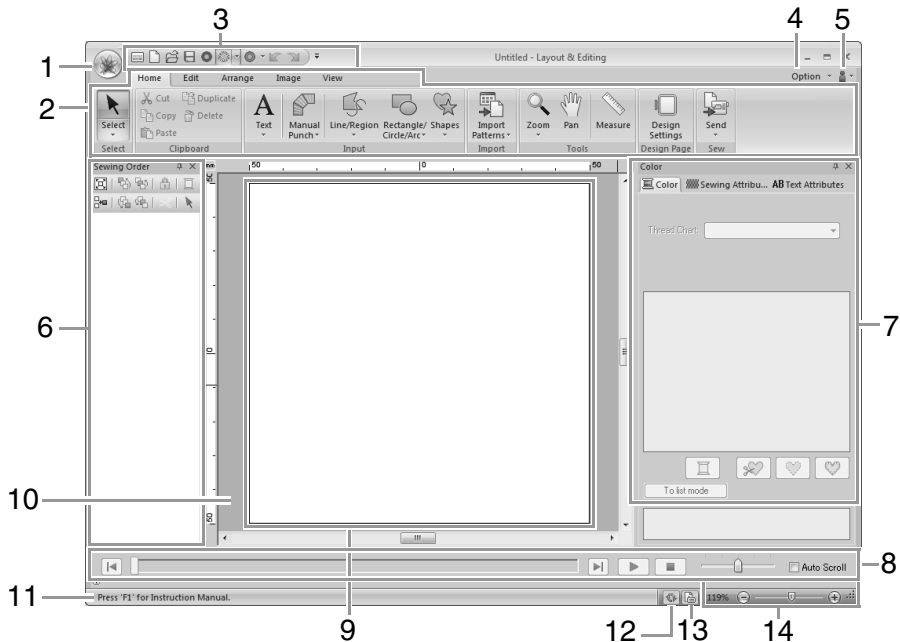

1 Application button

Click to display a menu containing commands for file operations, such as **New**, **Save** and **Print**.

2 Ribbon

Click a tab at the top to display the corresponding commands. Refer to the name below each group when selecting the desired command. Clicking a command with the ▾ mark displays a menu containing a choice of commands. Some other tabs may appear depending on the tool or embroidery pattern that is selected. These tabs contain various commands for performing operations with the selected tool or embroidery pattern. Example: When the Outline (Rectangle) tool is selected



3 Quick Access Toolbar

This contains the most frequently used commands. Since this toolbar is always displayed, regardless of the Ribbon tab that is selected, adding your most often used commands makes them easily accessible.

 *"Customizing Quick Access Toolbar" on page 273*

4 Option button

Click this button to start up other applications and specify settings for the Design Page and user thread chart.

5 Help button

Click this button to display the Instruction Manual and view information about the software.

6 Sewing Order pane

This pane shows the sewing order. Click the buttons at the top of the pane to change the sewing order or thread color.

7 Color/Sewing Attributes/Text Attributes pane

This pane combines tabs for specifying thread colors, sewing attributes and text attributes. Click a tab to display the available parameters.

8 Stitch Simulator pane

The Stitch Simulator shows how the pattern will be sewn by the machine and how the stitching will appear.

9 Design Page

The actual part of the work area that can be saved and sewn.

10 Work area

11 Status bar

This displays the size of the embroidery data, the number of stitches or a description of the selected command.

12 Refresh Window button

Click to update the screen.

13 Design Property button

Click to display a dialog box containing sewing information for the embroidery data.

14 Zoom

This displays the current magnification ratio. Click to specify a value for the magnification ratio.

Drag the slider to change the magnification ratio.

Memo:

- Panes 6, 7 and 8 can be displayed or hidden from the **Show/Hide** group in the **View** tab. In addition, these panes can be displayed as separate dialog boxes (**Floating**) or attached to the main window (**Docking**).
- Position the pointer over a command to display a **ScreenTip**, which provides a description of the command and indicates its shortcut key.

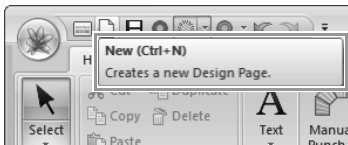

Customizing the window

Quick Access Toolbar/Ribbon

A menu appears when 1 in the Quick Access Toolbar is clicked.

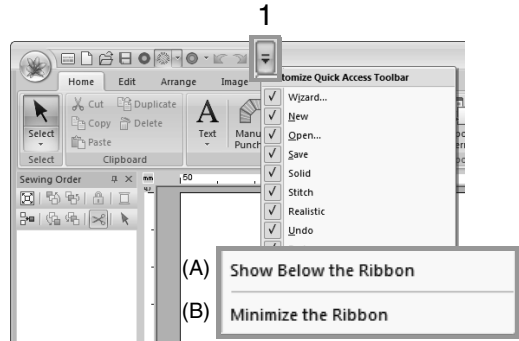

Click (A) to move the Quick Access Toolbar below the Ribbon.

To return it to its original position, display the menu as described above, and then click **Show Above the Ribbon**.

If a check mark appears beside (B), the Ribbon is minimized. When a tab is clicked, the Ribbon appears. After a command is selected, the Ribbon is minimized again.

To restore it to its original display, clear the check mark.

Example: With (A) selected and a check mark beside (B)

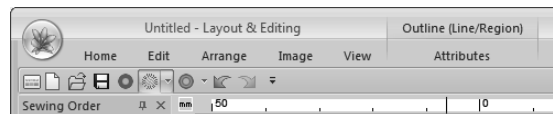

■ Quick Access Toolbar commands

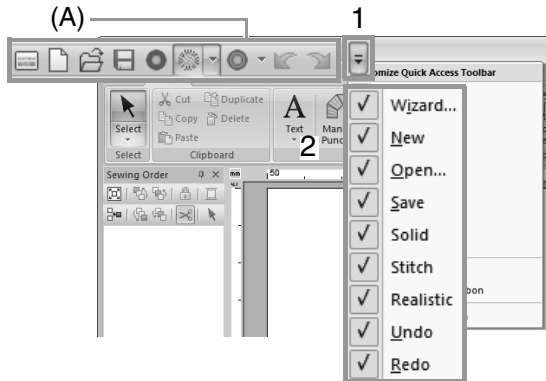

The first time this application is started up, the following commands appear in the Quick Access Toolbar (A).

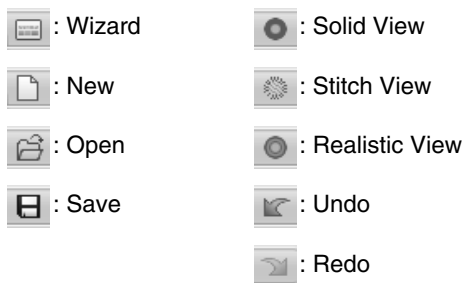

Click **1**, then **2** to switch between displaying and hiding each command.

When the check mark is cleared, the command is hidden.

Alternatively, changes to the Quick Access Toolbar can be specified in the **Options** dialog box and all applied at the same time.

 *"Customizing Quick Access Toolbar" on page 273*

■ Color/Sewing Attributes/Text Attributes pane, Sewing Order pane and Stitch Simulator pane

Floating

Each tab or the entire pane can be undocked to become a dialog box that can be moved around the screen.

- Double-click the title bar of the pane, or tab.
- Right-click the pane or tab, and then click **Floating**.
- Drag a tab out of the pane.

Docking

Each pane can be docked back to the window.

- Double-click the title bar.
- Right-click the pane, and then click **Docking**.
- Drag the title bar to the location where the pane will be docked.

Hide

When a tab or a pane is no longer needed, it can be hidden.

- Click  in the upper-right corner of the dialog box.
- Right-click the tab or dialog box, and then click **Hide**.
- To hide the tab, click **View** tab in the Ribbon, and then click the name in the **View** tab. To display the tab again, perform the same operation.

Auto Hide

When a pane is temporarily not needed, it can be moved to the side bar, then displayed by clicking it or positioning the pointer over it. The pane is automatically hidden again when it is no longer being used, for example, when you click anywhere outside of the pane.



- Right-click the tab or the title bar of the pane, and then click **Auto Hide**.
- In the upper-right corner of the pane, click .

To cancel Auto Hide, right-click the title bar, and then click **Auto Hide**, or simply click  in the title bar.



Memo:

The Stitch Simulator pane cannot be temporarily hidden (Auto Hide).

■ Using access keys

When the **Alt** key is pressed, a KeyTip (label showing the letter of the access key) appears on each command. On the keyboard, press the key corresponding to the command that you wish to use.

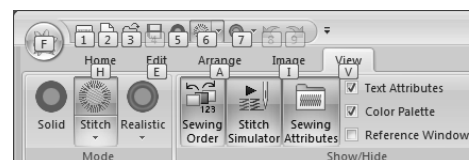

To stop using the access keys and hide the KeyTips, press the **Alt** key.

Specifying Basic Software Settings

Adjusting on-screen measurements (Screen Calibration)

Measurements can be adjusted so that objects will be displayed at the same size as the actual embroidery at a zoom ratio of 100%. Once this adjustment is made, it will not need to be done again later.

1. Click 1, then 2.



2. Click **Screen Calibration** (1). Hold a ruler against the screen to measure the length of 2. Next, enter the value at 3, and then click **OK** (4).

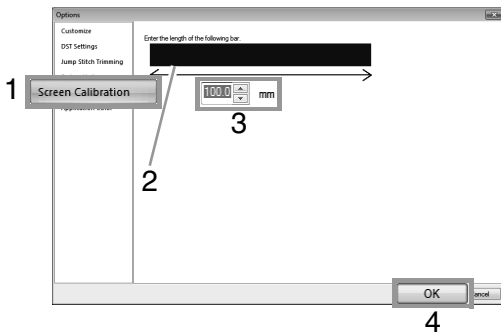

Be sure to enter the length in millimeters. A value in inches is invalid.

System unit

1. Click **System Unit**, and then select the desired measurement units (**mm** or **inch**).

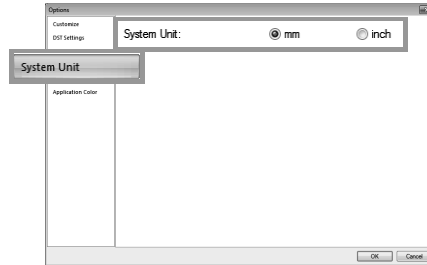

Getting Started

This section describes basic operations for this software through procedures for making embroidery patterns.

First, follow the procedures in this section to create embroidery patterns and learn the basic operations.

In this example, we will create an original embroidery pattern by combining an embroidery pattern.

Then, we will transfer the data to the embroidery machine.

Tutorial 1: Getting Started



The sample file for this tutorial can be found at the following location.

Documents (My Documents)\PE-DESIGN NEXT\Tutorial\Tutorial_1

Step 1	Starting up Layout & Editing
Step 2	Using the Auto Punch function to create an embroidery pattern from an image
Step 3	Adjusting the embroidery pattern size and position
Step 4	Adding text and setting character spacing
Step 5	Transforming the text
Step 6	Importing and rotating an embroidery pattern
Step 7	Transferring embroidery patterns to embroidery machines <ul style="list-style-type: none"> •Transferring the design to an original card •Transferring data to embroidery machines via a USB media

Step 1 Starting up Layout & Editing

Click  (Start), and then select **All Programs**, then **PE-DESIGN NEXT**, then **PE-DESIGN NEXT (Layout & Editing)**.

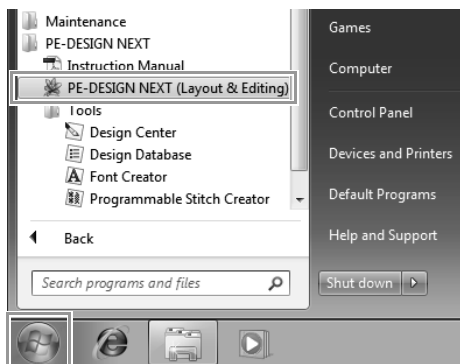

Step 2 Using the Auto Punch function to create an embroidery pattern from an image

Now, we will open the image of the tulip and convert it to an embroidery pattern.

1 Click 1, then 2, then 3.

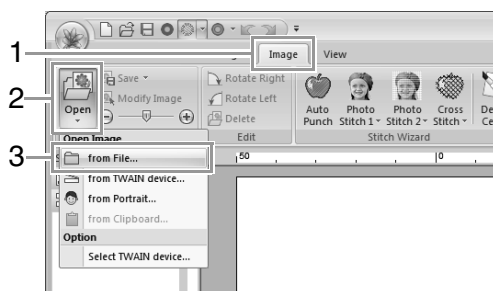

- 2 Import the file **tulip.bmp**.
Select the file **tulip.bmp** in the folder **Documents (My Documents)\PE-DESIGN NEXT\Tutorial\Tutorial_1**

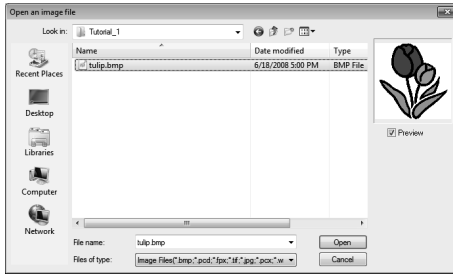

👉 *"Importing Image Data" on page 137*

- 3 Move the pointer over a handle, and then, while holding down the **Shift** key and the left mouse button, drag the mouse to reduce the size of the image.

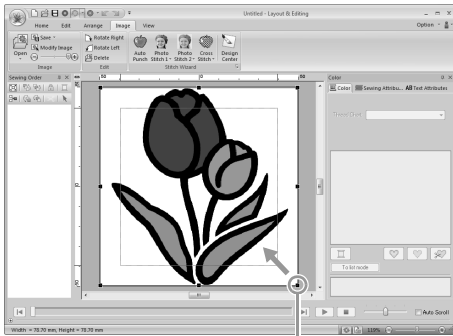

Handle

- 4 Click 1.

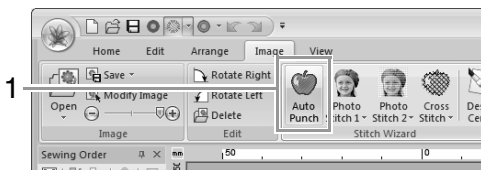

- 5 Click **Next**.

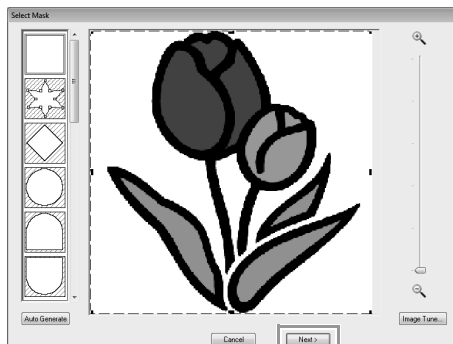

- 6 Click **Next**.

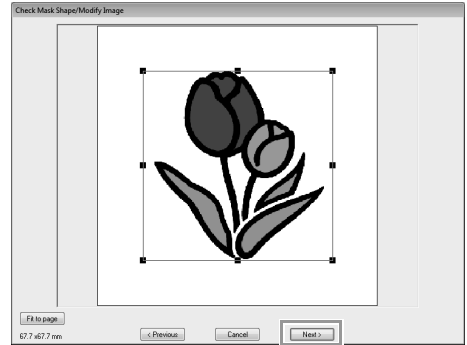

- 7 Click **Finish**.

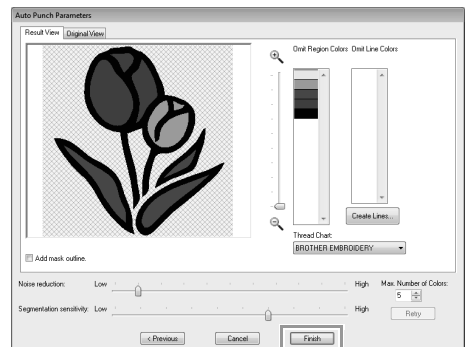

→ An embroidery pattern of the tulip is created.

👉 *"Tutorial 6-1: Auto Punch" on page 119*

Step 3 Adjusting the embroidery pattern size and position

- 1 Click the embroidery pattern to select it.

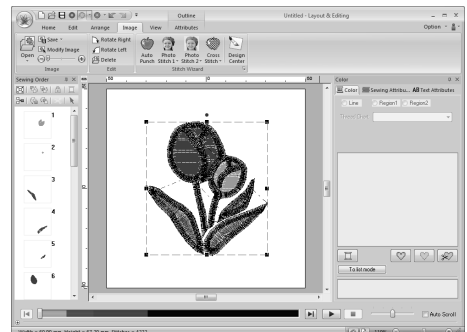

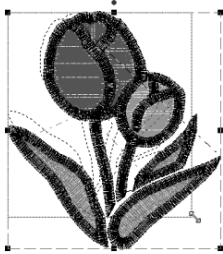

- 2 Move the pointer over a handle, and then, while holding down the left mouse button, drag the mouse to adjust the selected pattern to the desired size.



Memo:

- If a handle is dragged while the **Shift** key and the left mouse button are held down, the pattern is enlarged or reduced from the center of the pattern.
- The size of the embroidery pattern appears in the status bar.

- 3 To adjust the positions of the embroidery patterns, click the pattern, and then position the pointer over the pattern. When the shape of the pointer changes to , hold down the left mouse button and drag the pattern to the desired location.

 "Editing Embroidery Designs" on page 50

Step 4 Adding text and setting character spacing

- 1 Click 1, then 2, then 3.

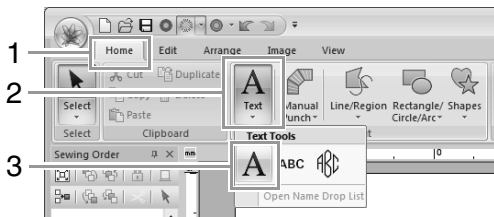

- 2 Click below the tulip in the Design Page.
→ A vertical dashed line will appear on the Design Page.

- 3 From the keyboard, type in "Tulip".

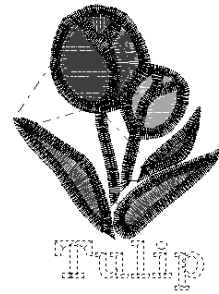

- 4 Press the **Enter** key.
→ The text is entered.
- 5 Click the text to select it.
- 6 Click 1 in the **Color** tab to change the color of the font.

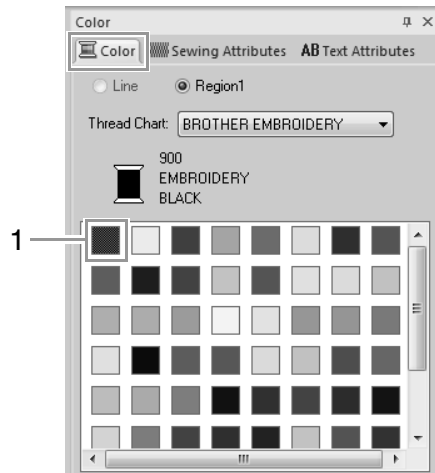

- 7 Set **Character Spacing (1)** in the **Text Attributes** tab to **6.5 mm**.

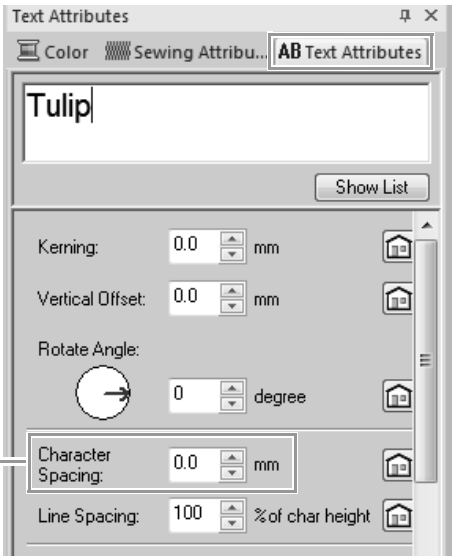

Specify the setting by clicking the selector and typing in the value, or by clicking or .

"Entering text" on page 92 and "Specifying various text attributes" on page 94

Step 5 Transforming the text

- 1 Click the text to select it, select the **Transform** check box (1), and then click 2.

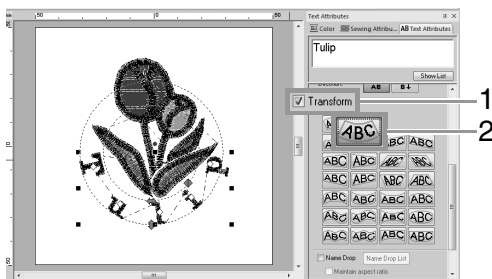

- 2 Move the pointer over , or , and then, while holding down the left mouse button, drag the mouse to transform the text.

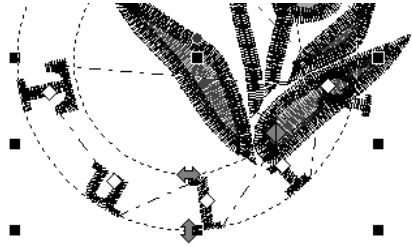

- : Adjusts the text size.
- : Moves the text along the circle.
- : Adjusts the radius of the circle.

"Transforming text" on page 91 and "Transforming text" on page 95

Step 6 Importing and rotating an embroidery pattern

Now, we will import the embroidery pattern for the butterfly.

- 1 Click 1, then 2, then 3.

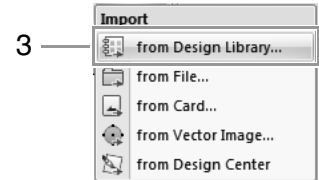
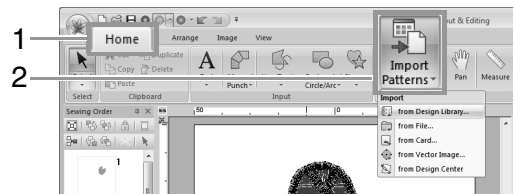

- 2 From the **Category** selector, select **Animals**.

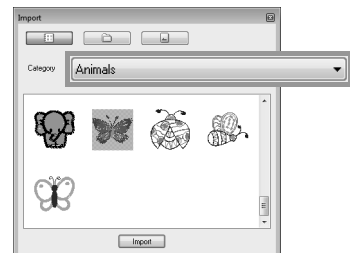

- 3 Move the pointer over the butterfly, and then, while holding down the left mouse button, drag the mouse to import the pattern into the Design Page, as shown in the illustration.

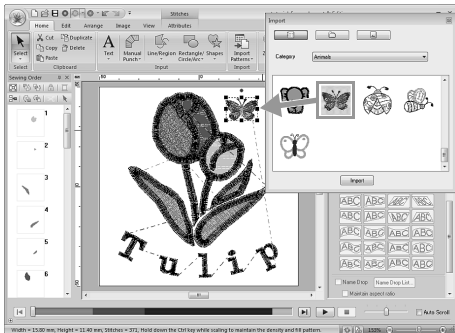

☞ *“Importing embroidery designs” on page 78*

- 4 Click  in the **Import** dialog box to close it.
- 5 Move the pointer over the rotation handle (1), and then, while holding down the left mouse button, drag the mouse to adjust the angle of the pattern.

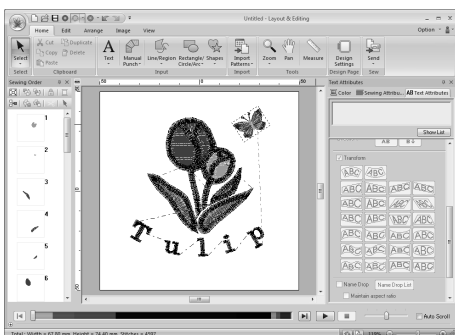

Note:

When imported stitch patterns are enlarged or reduced, the embroidering quality may be reduced.

☞ *“Enlarging/Reducing Stitch Patterns” on page 268.*

Step 7 Transferring embroidery patterns to embroidery machines

You can sew a pattern transferred to your sewing machine by writing it to media.

There are many methods to transfer data; however, the procedures for two of these methods are described below.

- Writing to an original card (p. 28)
Data can be transferred to embroidery machines compatible with original cards.
- Transferring data to embroidery machines via a USB media (p. 29)
Data can be transferred to embroidery machines equipped with a USB-B connector.

Memo:

- You can also use a floppy disk, Compact Flash card and USB media to transfer designs that can be used with your machine.

☞ *“Transferring to a machine by using USB media” on page 175*

- The Link function can be used to transfer embroidery data to compatible embroidery machines.

☞ *“Using the Link Function to Embroider From the Computer” on page 177*

■ Transferring the design to an original card

- 1 Insert an original card into the USB card writer module.

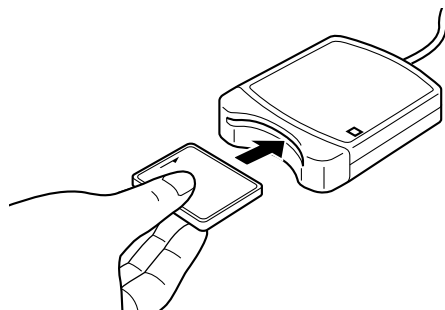

2 Click 1, then 2, then 3.

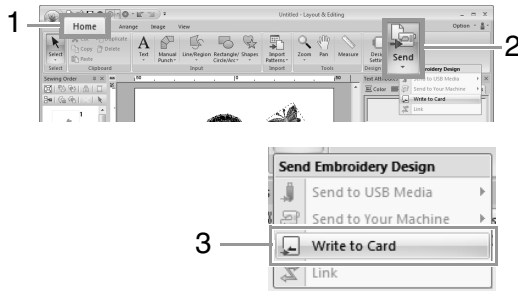

3 Click OK.

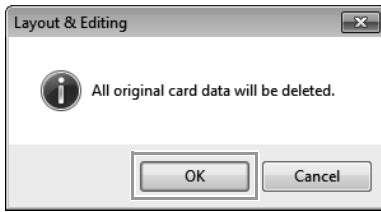

Note:

- When writing to an original card that already contains data, all data on the card will be deleted.
- Before using an original card, check that the designs on the card are no longer needed.
- If you wish to keep the designs, store them on a hard disk or other storage media.

"From an embroidery card" on page 79

4 When the writing is finished, the following message appears. Click OK.

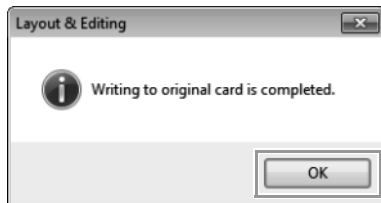

Memo:

- Stitch data is compressed to fit on an original card.
- Depending on the compression method, the size of the data may change.

Note:

Precautions for using the card writer module/original cards

- The original card is inserted correctly when you hear it snap into place.
- Never remove an original card or unplug the USB cable while the LED indicator is flashing.

"Transferring to a machine by using an original card" on page 174
For details on saving embroidery patterns, refer to "Saving" on page 81.

Transferring data to embroidery machines via a USB media

1 Plug the USB media into the computer.

2 Click 1, then 2, then 3, then 4.

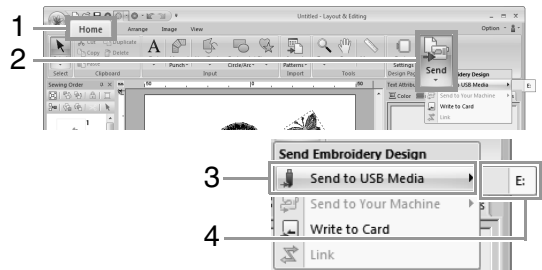

→ Data transfer begins.

3 When the transferring is finished, the following message appears. Click OK.

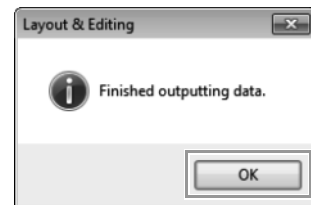

4 After an embroidery pattern is transferred, remove the USB media from the computer.

5 Insert the USB media into the USB port on the machine.

Memo:

For details on using the embroidery machine, refer to the Operation Manual included with it.

Basic Layout & Editing Operations

This section describes the basic operations performed in Layout & Editing, such as drawing shapes, editing the embroidery design, specifying sewing attributes, saving the file and printing it.

Tutorial 2: Drawing shapes to create an embroidery design

This section will describe how to draw various shapes and combine them to create an embroidery design. The Shape tools in Layout & Editing allow you to draw various shapes. Using these tools, we will draw the stem, leaves, flower and flower pot.

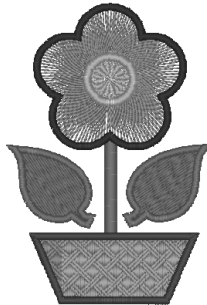

The sample file for this tutorial can be found at the following location.
Documents (My Documents)\PE-DESIGN NEXT\Tutorial\Tutorial_2

Step 1	Drawing and moving shapes
Step 2	Duplicating, flipping and moving shapes
Step 3	Specifying hole sewing
Step 4	Applying a pattern to stitching
Step 5	Editing points and modifying shapes

Step 1 Drawing and moving shapes

We will follow the procedure described below to draw shapes.

- 1 Select the Shape tool.

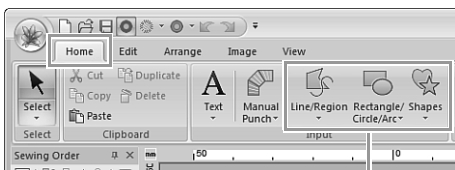

Shape tools

- 2 Specify the thread color and sew type for the lines.
- 3 Specify the thread color and sew type for the regions.
- 4 Drag the pointer in the Design Page to draw the shape.

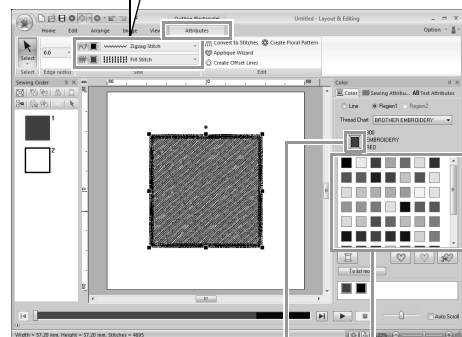
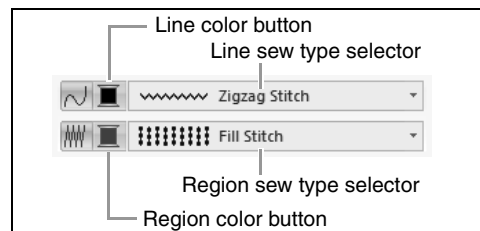

Thread color palette
 Selected thread color and color name

- 1 Draw the stem.
- (A) Click **1**, then **2**, then **3**, and then click the **Attributes** tab (**4**), and turn on line sewing with **5**.

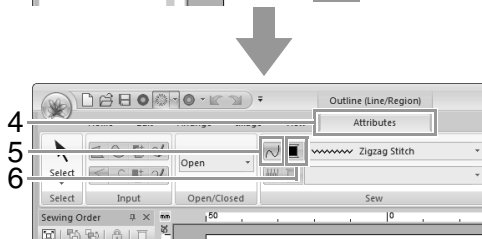
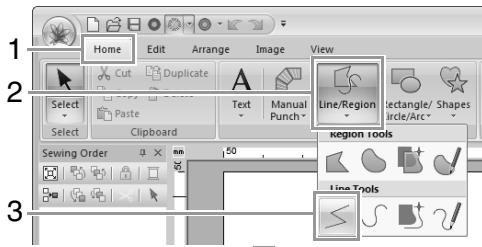

- (B) Click **6** for line sewing to display the color palette.
Click **LIME GREEN**.
If the desired color is not displayed, move the scroll bar until it appears.

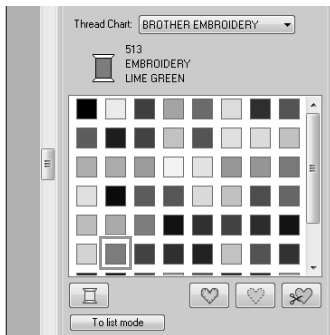

Memo:

To view the thread colors in a list so that the desired color can more easily be found, click **To list mode**.

☞ "Setting the thread color and sew type" on page 56.

- (C) Click in the **Line sew type** selector, and then click **Zigzag Stitch**.

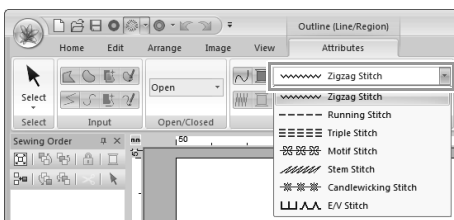

- (D) Click the start point **1**, and then double-click the end point **2**.

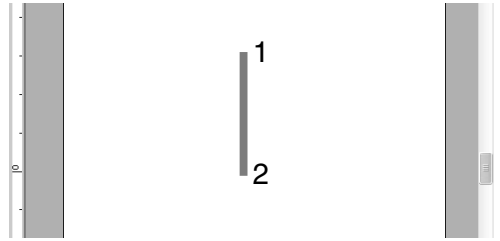

- 2 Draw the leaf on the right.

This time, we will also specify the color and sew type for the region, then draw the shape.

- (A) Click **1**, then **2**, then **3**.

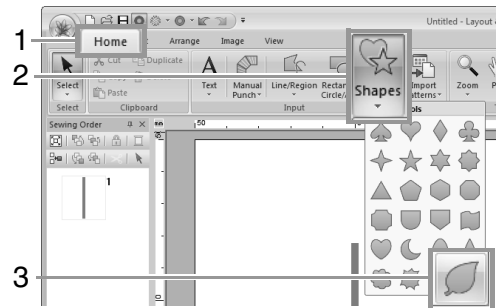

- (B) Click **4** for line sewing, and then click **LIME GREEN** in the color palette.

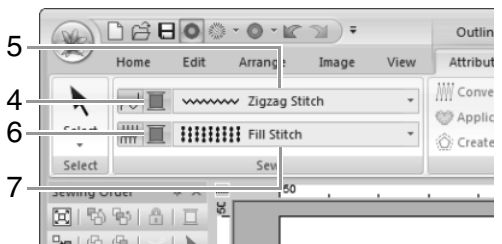

- (C) Click in the **Line sew type** selector (**5**), and then select **Zigzag Stitch**.

- (D) Click **6** for region sewing, and then click **LIME GREEN** in the color palette.

- (E) Click in the **Region sew type** selector (**7**), and then select **Fill Stitch**.

Memo:

The color, sewing attributes and size can also be changed after the shape is drawn.

- (F) While holding down the **Shift** key, drag the pointer in the Design Page, as shown in the illustration.

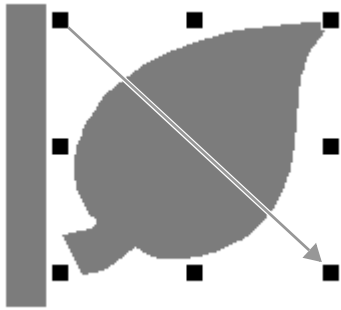

Memo:

To draw the shape while maintaining its height-to-width proportion, hold down the **Shift** key while dragging the pointer.

- (G) Place the pointer over the leaf so that the shape of the pointer changes to , and then drag the leaf to the desired position.

Step 2 Duplicating, flipping and moving shapes

Now, we will duplicate the leaf on the right side, flip it horizontally, and then move it to the left side of the stem.

- 1 To duplicate the leaf on the right.

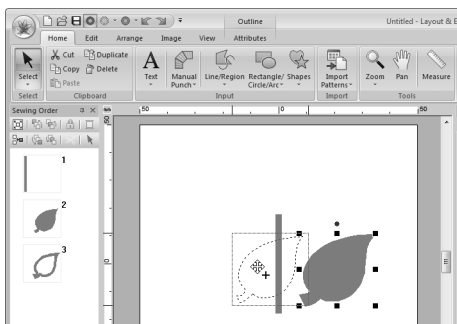

- (A) Select the leaf.
 (B) While holding down the **Ctrl** key, drag the leaf to move it.
 (C) Release the mouse button.

- 2 To flip the duplicated leaf horizontally.

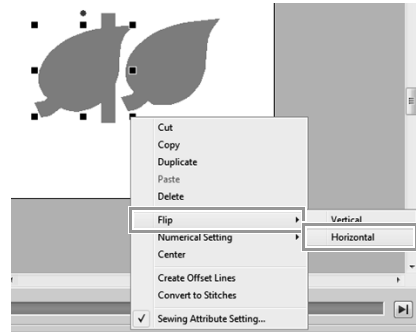

- (A) Right-click on the duplicated leaf.
 → A drop down menu will appear.
 (B) Click **Flip**, then **Horizontal**.

- 3 Drag the duplicated leaf to the left side of the stem.



Memo:

To move an object horizontally, hold down the **Shift** key while dragging the object.

- 4 Align the leaves on the left and right sides.

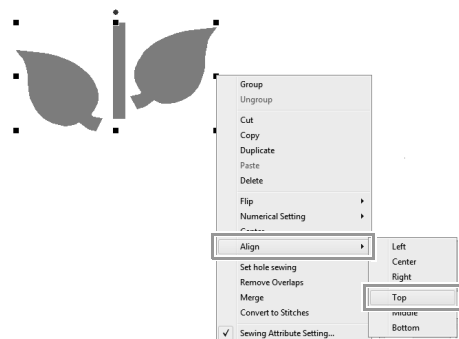

- (A) While holding down the **Ctrl** key, click the leaf on the right side, then the leaf on the left side to select the two leaves. Then, right-click the selected leaves.

 **Memo:**

- Multiple embroidery patterns can be selected in any of the following ways.
- Click the first pattern, and then, while holding down the key, click the next pattern.
- Drag the pointer to draw a selection frame around the patterns to be selected.
- Click **Mirror** in the **Arrange** tab to create mirror copies.

 "Using the Mirror Copy tool" on page 53.

(B) Right-click the leaves, and then click **Align**, then **Top**.

Step 3 Specifying hole sewing

Now, we will draw the flower and a circle at the center. Then, we will apply a setting so that the overlapping areas are not sewn twice.

1 Draw the flower petals.

(A) Click **1**, then **2**, then **3**.

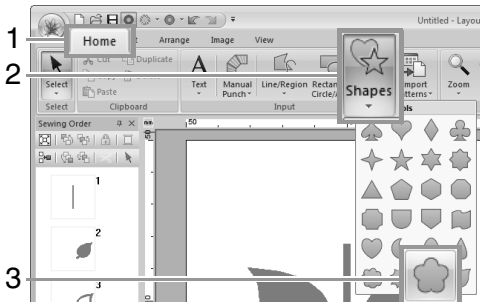

(B) Select **RED** in the color palette as the line color and **Zigzag Stitch** as the sew type (4).

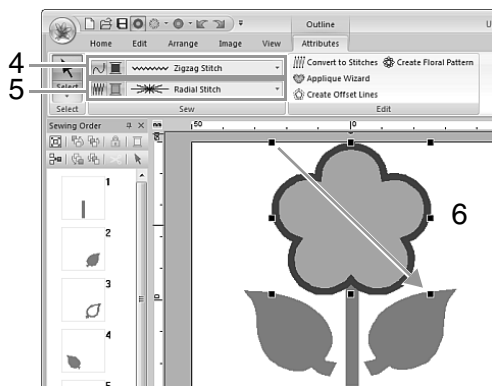

(C) Select **PINK** in the color palette as the region color and **Radial Stitch** as the sew type (5).

(D) While holding down the **(Shift)** key, drag **(6)** the pointer in the Design Page to draw flower petals of the desired size, as shown in the illustration.

2 Draw the circle at the center.

(A) Click **1**, then **2**, then **3**.

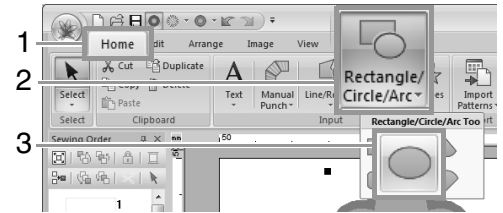

(B) Select **YELLOW** in the color palette as the line color and **Zigzag Stitch** as the sew type (4).

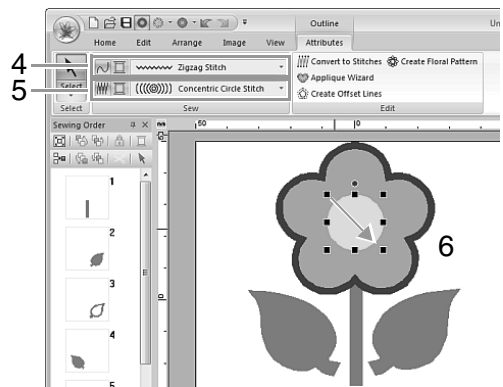

(C) Select **YELLOW** in the color palette as the region color and **Concentric Circle Stitch** as the sew type (5).

(D) While holding down the **(Shift)** key, drag **(6)** the pointer in the Design Page to draw a circle with the desired size at the center of the flower, as shown in the illustration.

(E) Drag the circle to the center of the flower petals.

3 Select the patterns where hole sewing is to be applied.

(A) While holding down the **Ctrl** key, click the yellow circle (1) and the flower petals (2).

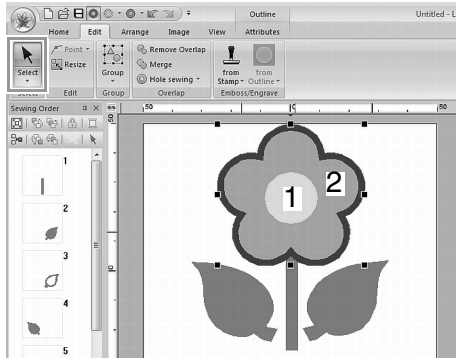

4 Specify hole sewing.

(A) Click 1, then 2, then 3.

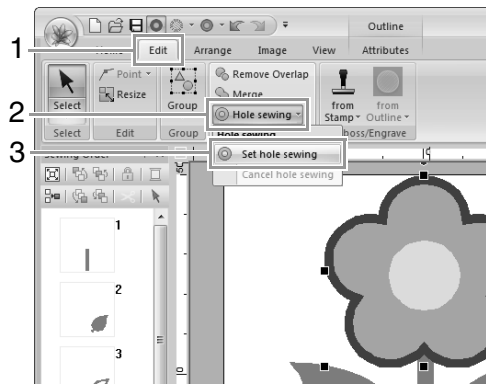

Note:
Hole sewing cannot be applied if one of the patterns is not completely enclosed within the other pattern.
 👉 "Hole sewing" on page 45.

Step 4 Applying a pattern to stitching

Detailed line and region attribute settings can be specified from the **Sewing Attributes** tab. Now, we will specify settings for region sewing for the flowerpot.

1 Specify the color and sew type for the line and region of the flowerpot.

(A) Click 1, then 2, then 3.

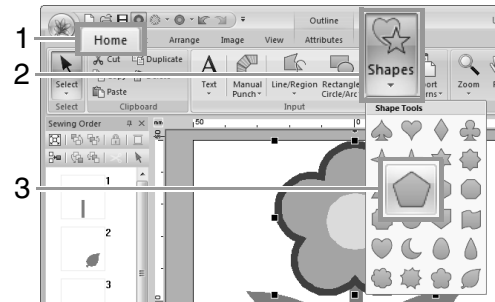

(B) Select **CLAY BROWN** in the color palette as the line color and **Zigzag Stitch** as the sew type (4).

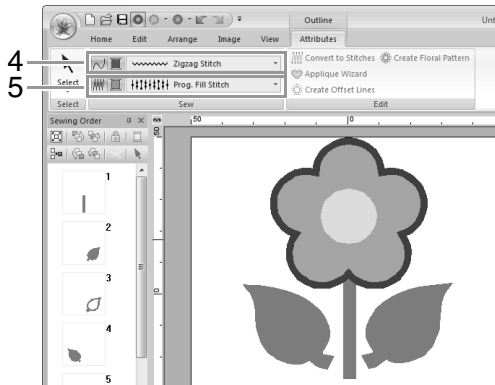

(C) Select **DEEP GOLD** in the color palette as the region color and **Prog. Fill Stitch** as the sew type (5).

2 Specify the sewing attributes.

- (A) Click **Sewing Attributes** tab.
If the **Sewing Attributes** tab is not displayed, click **View**, then **Sewing Attributes**.

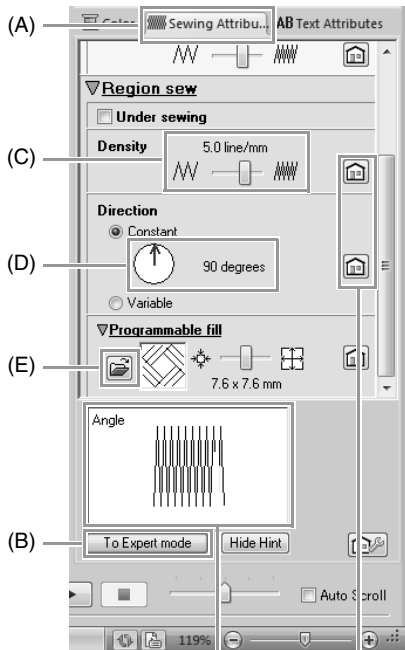

The effects of the specified settings can be previewed. This preview can be displayed/hidden by clicking the Show Hint/Hide Hint button.

Click this button to return the attribute to its default setting.

- (B) There are two display modes for the **Sewing Attribute Setting** dialog box. For this example, we will specify settings in Beginner mode.
- (C) Drag the **Density** slider to specify 5.0 line/mm.
- (D) Drag the red arrow in **Direction** area to 90°.
- (E) Click  in the **Programmable fill** section.

- (F) Select **net4**, and then click **OK**.

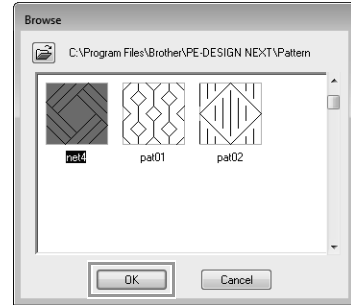

- (G) Move the slider to specify 7.6 x 7.6 mm.

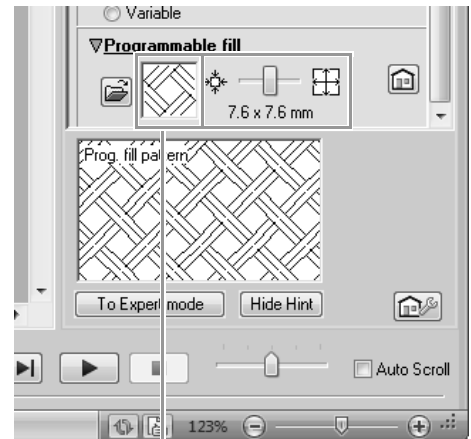

The selected pattern is displayed.



Memo:

- If the dialog box is displayed in Expert mode, click **To Beginner mode** to display the dialog box in Beginner mode.
- More detailed settings can be specified in Expert mode.



“Specifying sewing attributes” on page 58.

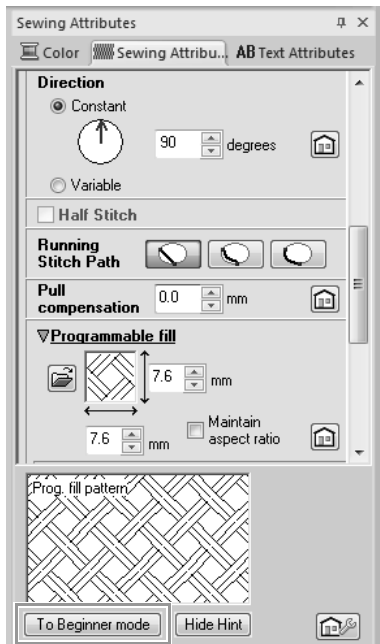

Step 5 Editing points and modifying shapes

Now, we will delete one corner from the pentagon to create a flowerpot.

- 1 Draw the flowerpot.

Drag the pointer in the Design Page, as shown in the illustration.

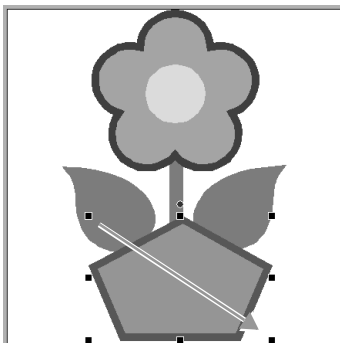

- 2 Delete a point.

- (A) Click 1, then 2, then 3.

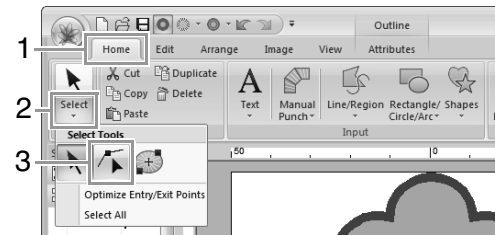

- (B) Click the shape for the flowerpot.

→ The points in the shape appear.

- (C) Right-click the top point to be deleted, and then click **Delete**.

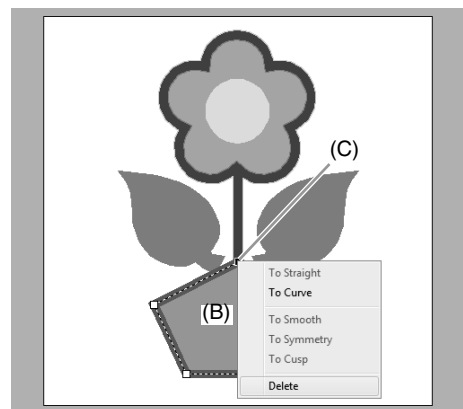

→ The point is deleted to form a trapezoid.

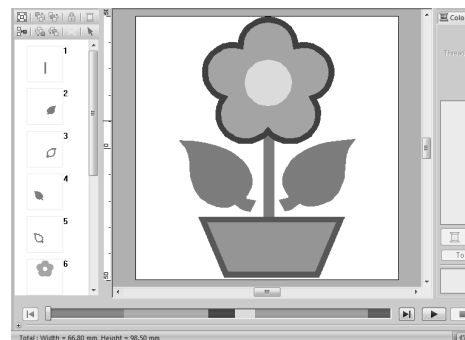

For details on saving embroidery patterns, refer to “Saving” on page 81. For details on transferring designs to an embroidery machine, refer to “Transferring Embroidery Designs to Machines” on page 174.

Drawing Shapes

Drawing rectangle, circle or arc shape

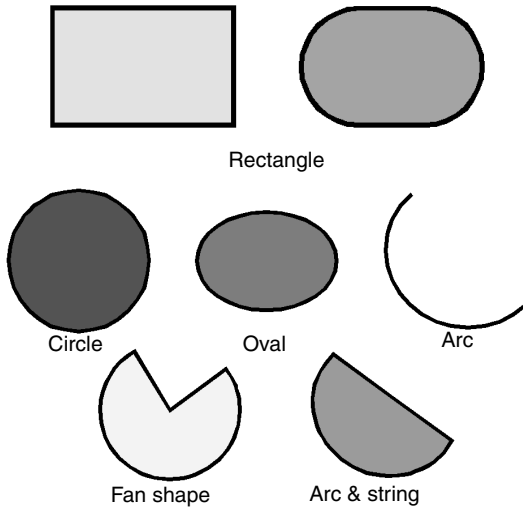

First, select the Rect/Circle/Arc tool. Click 1, then 2, then 3.

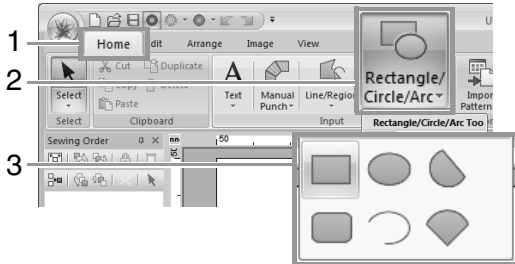

Drag the pointer in the Design Page.

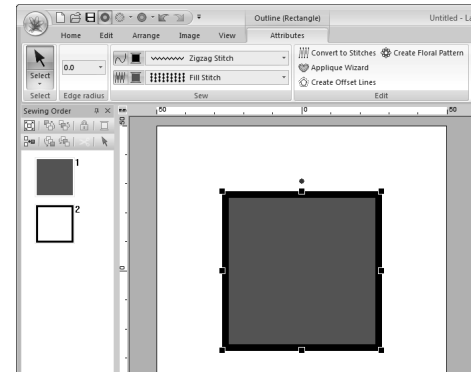
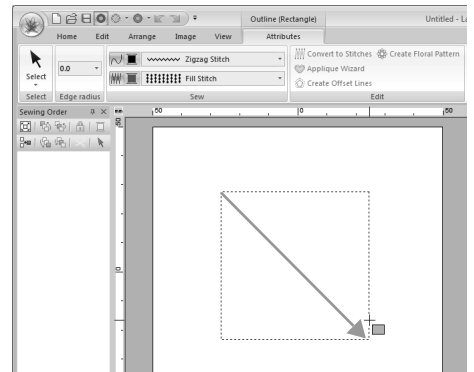

Memo:
 To draw a circle or square, hold down the **Shift** key while dragging the pointer.

 : Rectangle

 : Rectangle with rounded corners

 : Circle or Oval

Memo:

Rectangles with rounded corners

To change the radius of the corners, click the **Edge radius** selector, located in the Outline Attributes tab. Then type the desired radius and press the **Enter** key, or select the desired value.

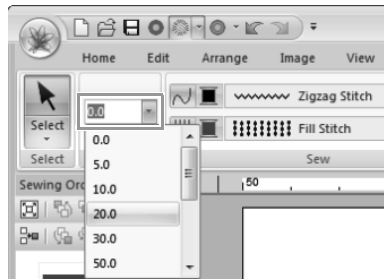

Example 1
Edge radius: 0.0 mm



Example 2
Edge radius: 20.0 mm

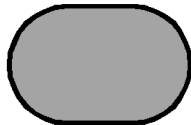

 : Arc

 : Arc & String

 : Fan

1. Proceed as you would to draw a circle or an oval.

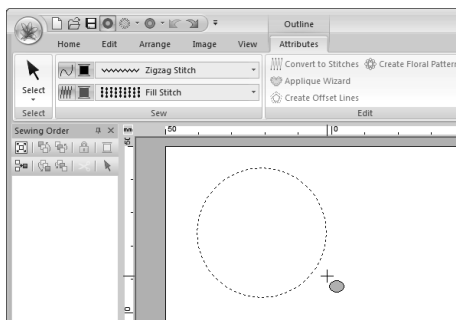

→ A radial line appears on the oval when the mouse button is released.

2. Move the pointer to the start point of the arc, and then click.

→ The radial line disappears.

3. Move the pointer until the arc/arc & string/fan has the desired shape, and then click.

Memo:

Dragging the pointer while holding down the **Shift** key moves it in 15° increments. The current angle is shown in the status bar.

Arc

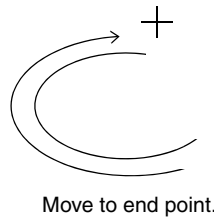
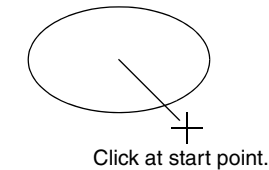

+ Click at end point.

Arc & String

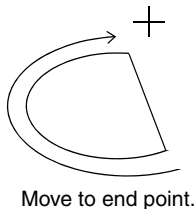
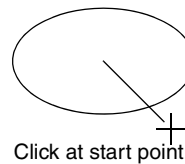

+ Click at end point.

Fan

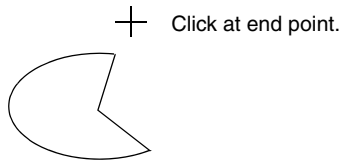
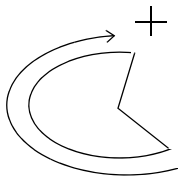
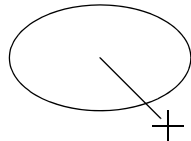

Memo:

- All of these patterns, except arcs have an outline and a inside region, and can independently be assigned different sewing attributes. Arcs are simple outlines.
- The outline of patterns created with the Fan Shape and Arc & String tools can be edited with the Select Point tool.

"Selecting points" on page 62.

- You can change the color and sew type either before or after drawing the shape.

"Setting the thread color and sew type" on page 56.

- You can also use the settings in the **Sewing Attributes** tab to define other attributes of the shape.

"Specifying sewing attributes" on page 58.

Drawing various shape

1. First, select the Shape tool. Click 1, then 2, then 3.

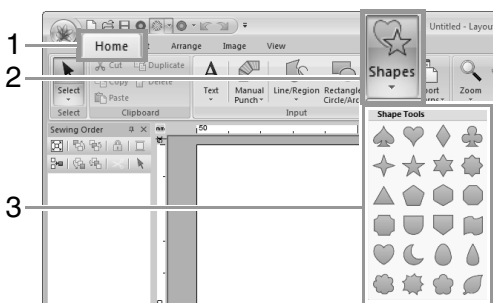

2. Drag the pointer in the Design Page.

Memo:

To draw the shape while maintaining the original height-to-width proportion, hold down the **Shift** key while dragging the pointer.

Drawing outlines (straight lines and curves)

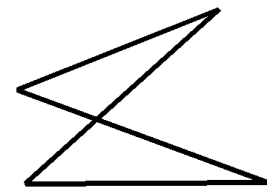
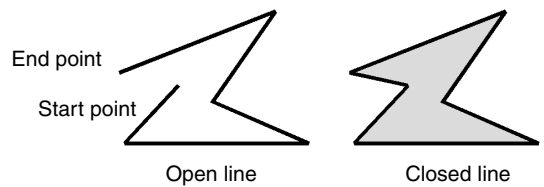

This closed line crosses itself, so the regions will not be filled.

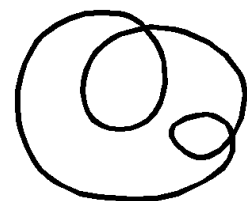
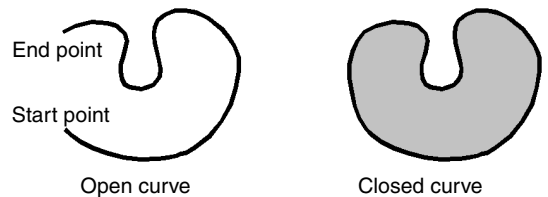







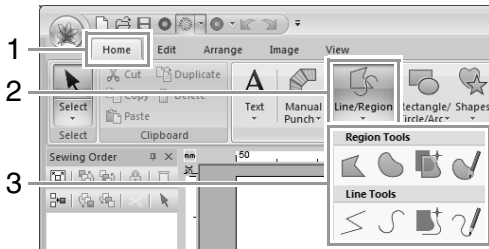

This closed curve crosses itself, so the regions will not be filled.

Memo:

If the line of the pattern crosses itself, the inside region cannot be filled, and the line must be uncrossed so that the fill can be applied.

1. First, select the Line/Region tool. Click **1**, then **2**, then **3**.



-  : Click points to draw a closed line constructed of straight lines. (Shortcut key: **Z**)
-  : Click points to draw a closed curve. (Shortcut key: **X**)
-  : When a template image is displayed, click along the outlines of the image to draw closed lines tracing the image. (Shortcut key: **C**)
-  : Drag the pointer to draw a closed freehand curve.
-  : Click points to draw an open line constructed of straight lines. (Shortcut key: **Z**)
-  : Click points to draw an open curve. (Shortcut key: **X**)
-  : When a template image is displayed, click along the outlines of the image to draw open lines tracing the image. (Shortcut key: **C**)
-  : Drag the pointer to draw an open freehand curve.

2. Click in the Design Page or drag the pointer to draw the line.

Memo:

- The shortcut keys are available only after a Line/Region tool has been selected.
- When a Region tool is selected, pressing a shortcut key switches to the corresponding Region tool. When a Line tool is selected, pressing a shortcut key switches to the corresponding Line tool.

■ Straight lines/curves

1. Click in the Design Page to specify the start point.

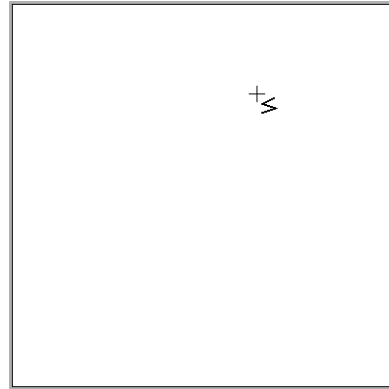

2. Click in the Design Page to specify the next point.

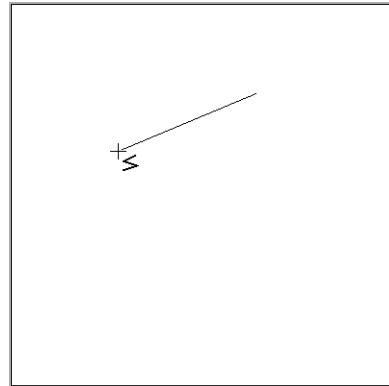

Memo:

- To remove the last point that was entered, click the right mouse button, or press the **BackSpace** key.
- The Curve tool and Semi-Automatic tool are used in the same way.

- Continue clicking to specify every point, and then double-click the last point, or press the **Enter** key.

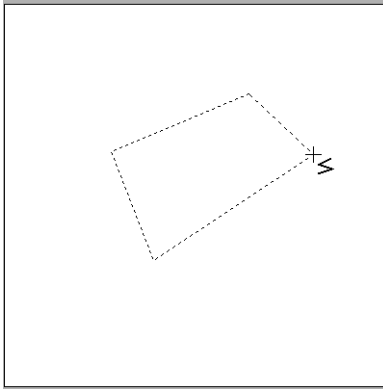

Memo:

- You can freely switch between the different line types either by clicking a different button or by pressing the shortcut key.
- When drawing a straight line, hold down the **Shift** key while moving the pointer to draw vertically or horizontally.
- Even after the pattern is drawn, you can change the attributes of line ends.

“Changing the attributes of line ends” on page 43.

- Even after the pattern is drawn, you can transform straight lines into curves and vice versa.

“Transforming straight lines into curves or curves into straight lines” on page 63.

Freehand lines

- Drag the pointer to draw the line.
- Release the mouse button to finish drawing.

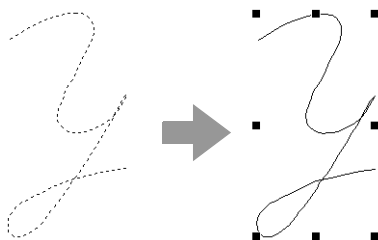

Changing the attributes of line ends

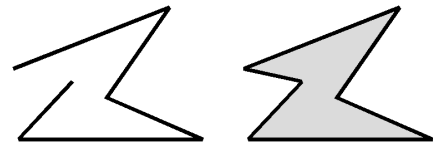

- Select an object drawn with a Line/Region tool. Then, click the **Attributes** tab.

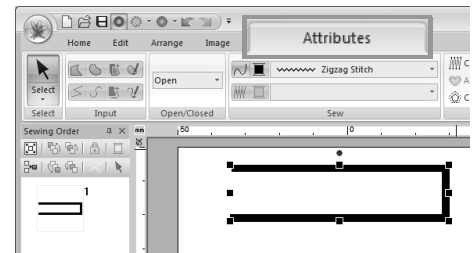

- From the **Path shape** selector, select **Open** or **Close** for the line ending.

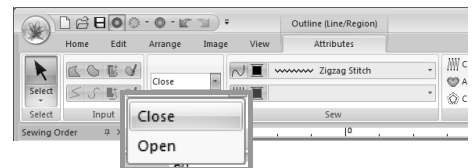





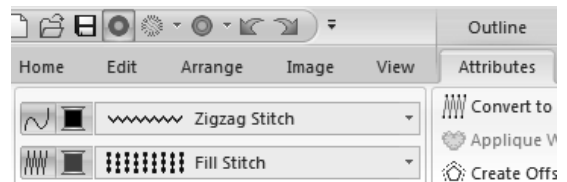

Embroidery attributes of shapes

The **Attributes** tab allows you to set the embroidery attributes (thread color and sew type, outline and inside region on/off).

Example 1: When a rectangle is selected.



 Line sew	Switches on/off sewing for the line.
 Region sew	Switches on/off sewing for the region.
 Line color Region color Punch color	Click this button to set the thread color for lines, regions, and manual punching patterns. Special colors  <i>“Special colors” on page 57</i>
 Zigzag Stitch Line sew type	
 Fill Stitch Region sew type	
Use these selectors to set the sew type for lines, regions, and manual punching patterns.	

 *“Applying Sewing Attributes to Lines and Regions” on page 56*

Creating a gradation/ blending

The density of one or two colors can be adjusted at various locations to create a custom gradation pattern.

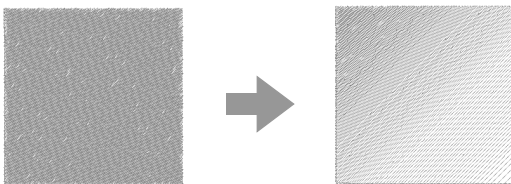

1. Select an embroidery pattern with region sewing specified.

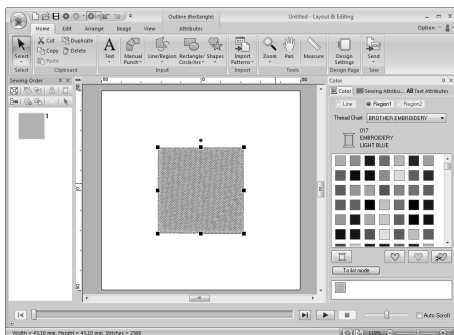

2. Click the **Sewing Attributes** tab.

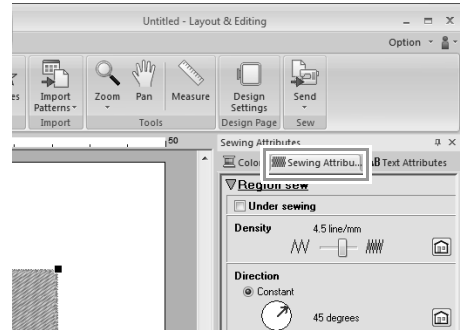

Memo:

*If the attributes are displayed in Beginner mode, click **To Expert mode**.*

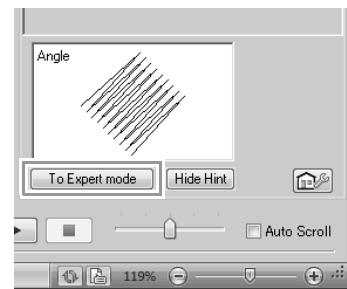

3. Select the **Gradation** check box, and then click **Pattern**.

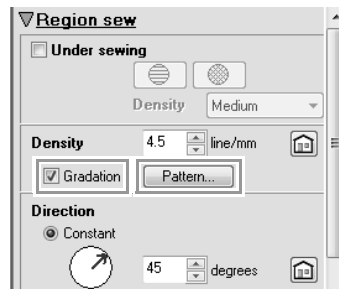

- Specify the desired settings in the **Gradation Pattern Setting** dialog box, and then click **OK**.

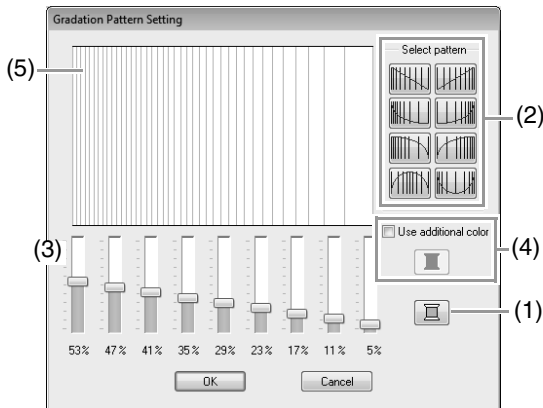

- To change the thread color, click . Select a color in the **Thread Color** dialog box that appeared, and then click **OK**.
- To select a preset gradation pattern, click the desired pattern under **Select pattern**.
- Move the sliders to adjust the density of the gradation pattern.
- To blend two colors, select the **Use additional color** check box, then click . Select a color in the **Thread Color** dialog box that appeared, and then click **OK**.

"Blending" on page 6

- The preview area shows the setting changes that you make.

Memo:

- Gradation/blending can be specified if satin stitches, fill stitches or programmable fill stitches have been selected for the region sewing and **Constant** has been selected as the sewing direction.
- If the **Use additional color** check box is cleared, the gradation settings are applied to the remaining color.
- The first and second colors of the gradation can also be changed by selecting **Region1** or **Region2** in the **Thread Color** tab.

Hole sewing

By specifying hole sewing, the stitching in overlapping regions will not be sewn twice. Hole sewing can be set only when one region completely encloses another.

Embroidery patterns created with the Rectangle, Circle or Arc tools, Shapes tools or Line/Region tools can be selected to set hole sewing.

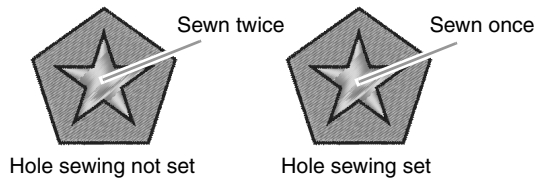

- Select a pair of patterns, for example, a star included in a pentagon.

While holding down the **Ctrl** key, click the star, then the pentagon.

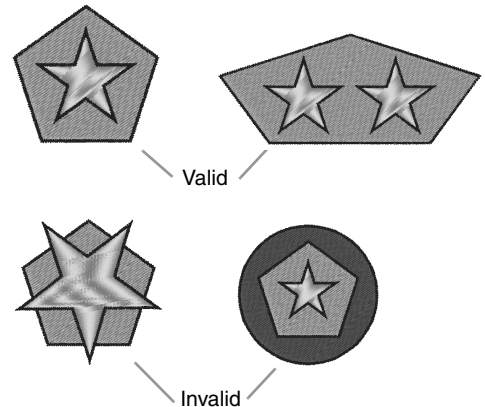

- Click 1, then 2, then 3.

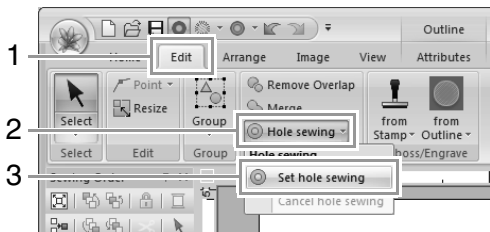

Memo:

To see better what the hole sewing setting does, preview the patterns before and after setting hole sewing.



"Stitch View" on page 70

Canceling hole sewing

- Select a pattern that has been set for hole sewing.
- Click 1, then 2, then 3.

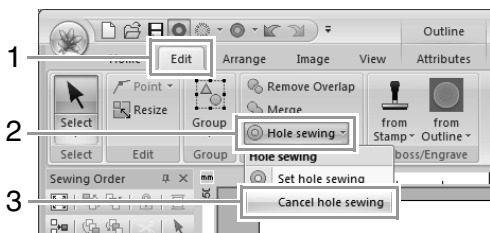

Changing shapes of overlapped patterns

Embroidery patterns created with the Rectangle, Circle or Arc tools, Shape tools or the Line/Region tools can be selected to remove overlapping regions or to be merged.

Removing overlapping

Overlapped patterns can be set so that the overlapping region is removed.

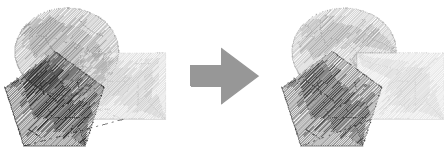

- While holding down the **Ctrl** key, click two or more overlapped patterns to select them.
- Click 1, then 2.

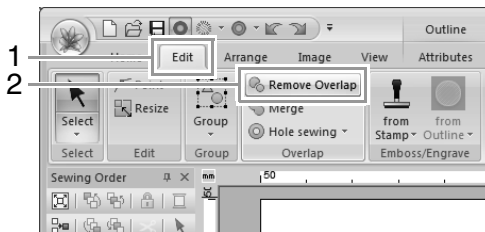

- When partially overlapped

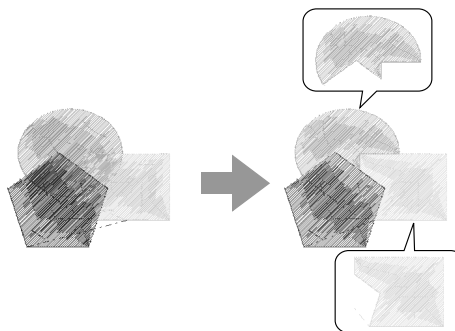

- When enclosed

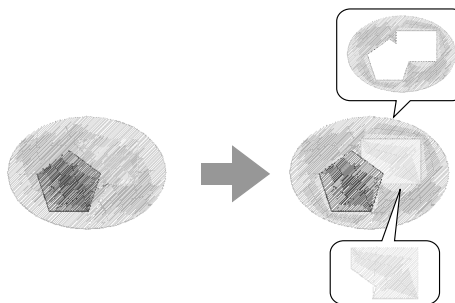

- First pattern in the sewing order
- Second pattern in the sewing order
- Third pattern in the sewing order

Merging

Overlapped pattern can be merged together.

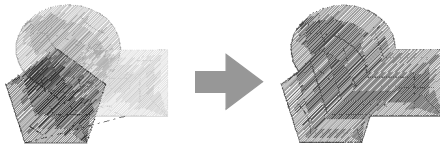

→ The color and sew type of the last pattern drawn (topmost pattern) is applied to the merged pattern.

1. While holding down the **Ctrl** key, click two or more overlapped patterns to select them.
2. Click **1**, then **2**.

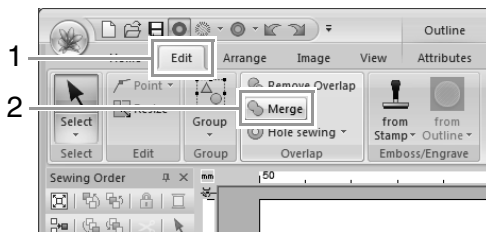

→ If this cannot be applied to the selected patterns, an error message appears.

- When partially overlapped

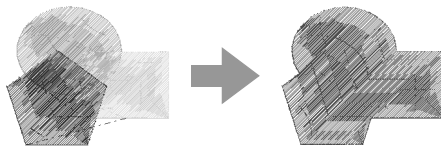

Creating a floral pattern

Line stitching in a floral pattern can be created based on the selected shape.

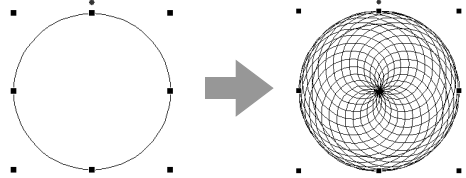

1. Draw a shape, and then select it.

Note:
Be sure to select a closed line.
"Changing the attributes of line ends" on page 43

2. Click **1**, then **2**.

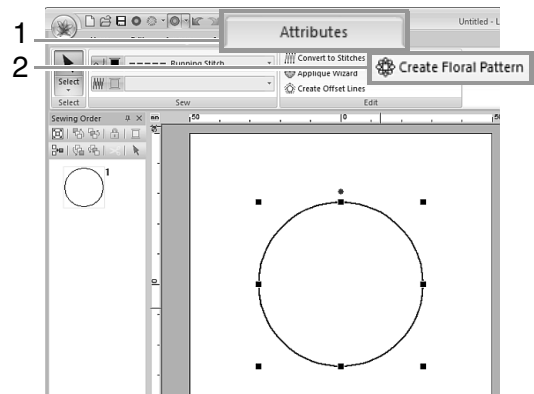

■ Easy mode

1. Drag the **Density** slider to adjust the pattern.

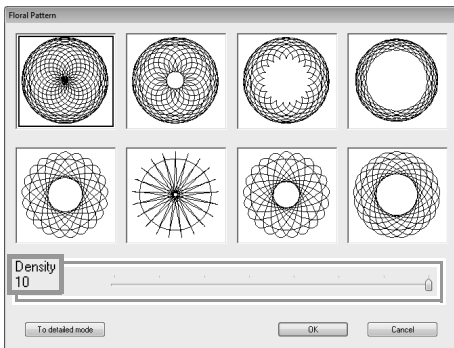
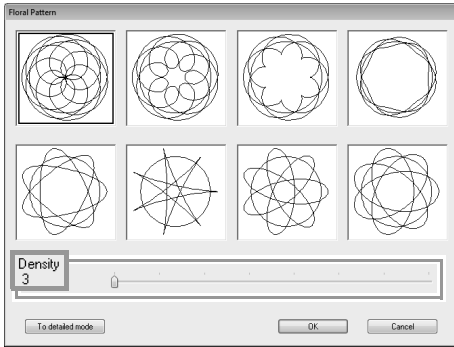

2. Click the desired pattern, and then click **OK**.

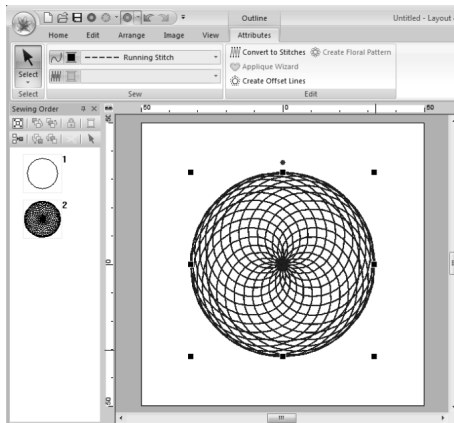

■ Detail mode

More detailed settings can be specified in Detail mode.

1. Click **To detailed mode** in the **Floral Pattern** dialog box.



2. Drag the **Density** slider and the **Pattern** slider to adjust the pattern.

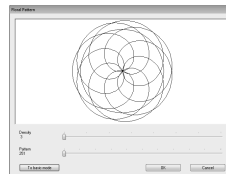

Density 3, Pattern 251

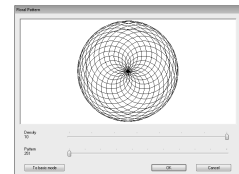

Density 10, Pattern 251

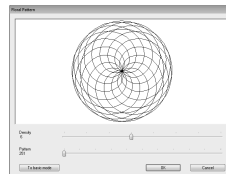

Density 6, Pattern 251

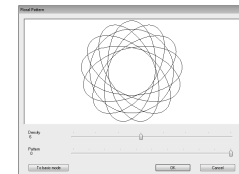

Density 6, Pattern 0

3. After the pattern has been adjusted as desired, click **OK**.

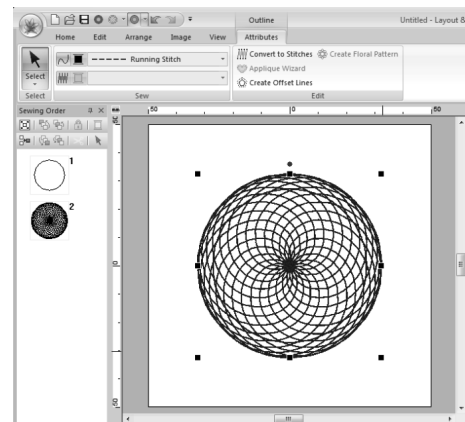

Memo:

The running stitch is specified for the floral line pattern.

Creating an offset line pattern

Line stitching in a concentric pattern can be created based on the selected shape.

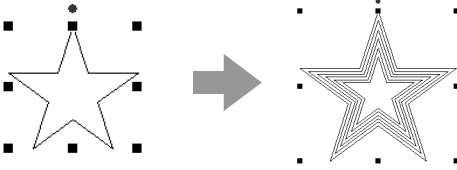

1. Draw a shape, and then select it.

Note:
Be sure to select one closed line.

"Changing the attributes of line ends" on page 43

2. Click 1, then 2.

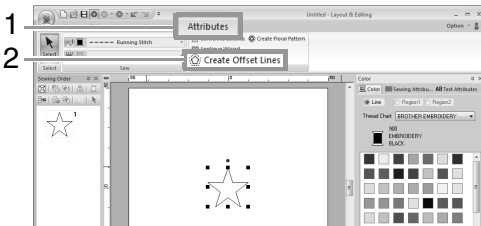

3. Specify the desired settings for the offset line pattern, and then click **OK**.

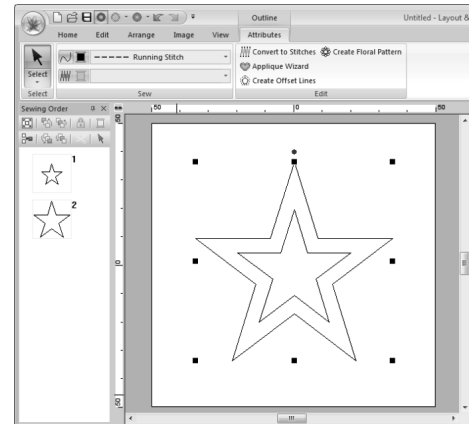
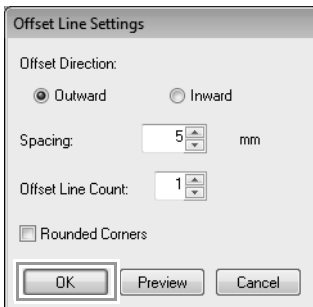

Offset Direction

Outward

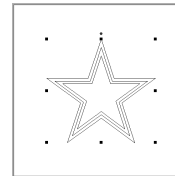

Inward

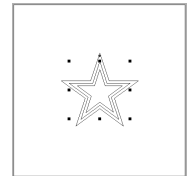

Spacing

1 mm

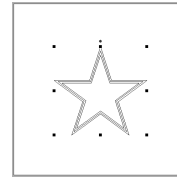

5 mm

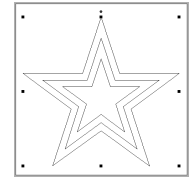

Offset Line Count

1 line

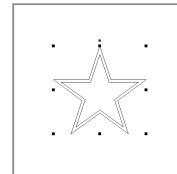

5 lines

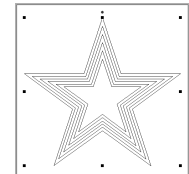

Rounded Corners

Check box selected.

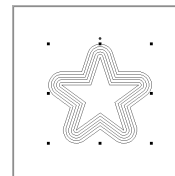

Check box cleared.

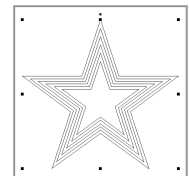

Editing Embroidery Designs

Selecting patterns

1. First, select the Select tool. Click 1, then 2.

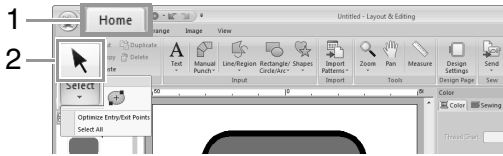

2. Click the pattern.

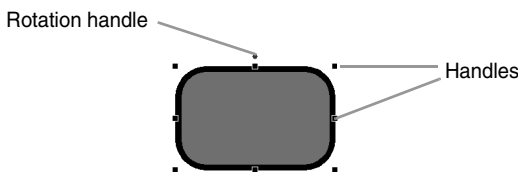

Memo:

- If is not displayed at 2, click the arrow at the bottom of the button, and then click .
- The status bar shows the dimensions (width and height) of the pattern.

3. To select an additional pattern, hold down the **Ctrl** key and click the other pattern.

Memo:

- You can also select patterns by dragging the pointer across the pattern.
- Press the **Tab** key to select the next pattern in the order that they were created.
- If multiple patterns are selected, a pattern can be deselected by holding down the **Ctrl** key while clicking the pattern.

Selecting all embroidery patterns

Click 1, then 2, then 3.

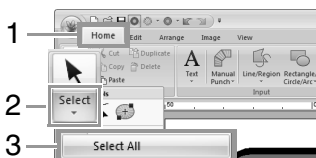

Memo:

- If is not displayed, click the arrow at the bottom of the button, and then click .
- All patterns can also be selected by pressing the shortcut keys **Ctrl** + **A**.
- Locked embroidery patterns cannot be selected.

"Locking embroidery patterns" on page 74

Moving patterns

Moving manually

Drag the selected pattern(s) to the desired location.

Memo:

- To move the pattern horizontally or vertically, hold down the **Shift** key while dragging it.
- Pressing the arrow keys moves the selected pattern.

Moving embroidery patterns to the center

Select the pattern(s), and then click 1, then 2, then 3.

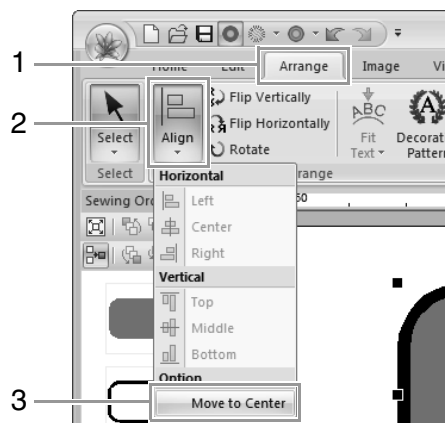

Aligning embroidery patterns

Select the patterns, and then click 1, then 2, then 3.

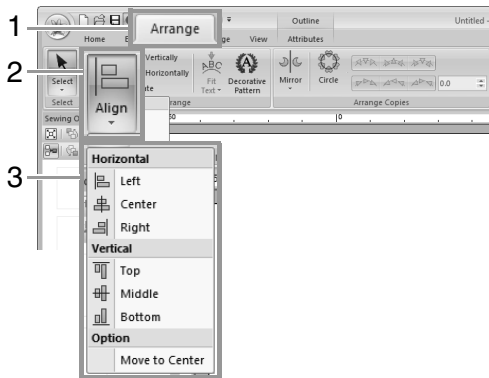

→ The selected patterns are aligned as shown below.

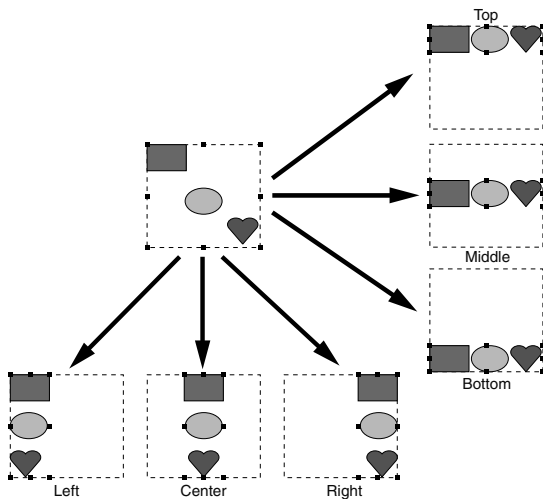

Scaling patterns

Scaling manually

1. Select the pattern(s).

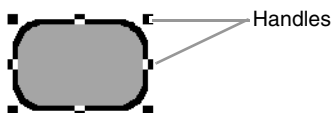

2. Drag the handle to adjust the selected pattern(s) to the desired size.

Note:
Some patterns imported from embroidery cards cannot be scaled.

Memo:

- If the **Shift** key is held down while a handle is dragged, the pattern is enlarged or reduced from the center of the pattern.
- As you drag the handle, the current size is displayed on the status bar.
- When scaling stitch patterns, the number of stitches remains the same, resulting in a loss of quality. To keep density and fill pattern of the embroidery pattern, hold down the **Ctrl** key while scaling.

☞ "Enlarging/Reducing Stitch Patterns" on page 268.

Scaling numerically

1. Select the pattern(s), and then click 1, then 2.

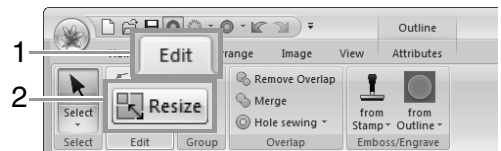

2. Specify the size, and then click **OK**.

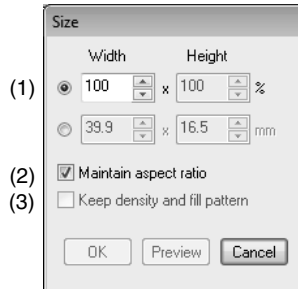

- (1) Select the whether the width and height will be set as a percentage (%) or a dimension (millimeters or inches). Set the width and height.
- (2) To change the width and height proportionally, select the **Maintain aspect ratio** check box.
- (3) To resize the selected pattern while maintaining the original density and fill pattern, select the **Keep density and fill pattern** check box.

Memo:

The **Keep density and fill pattern** check box is available only if stitch pattern is selected.

☞ "Enlarging/Reducing Stitch Patterns" on page 268.

Rotating patterns

Rotating manually

1. Select the pattern(s).
2. Drag the rotation handle.

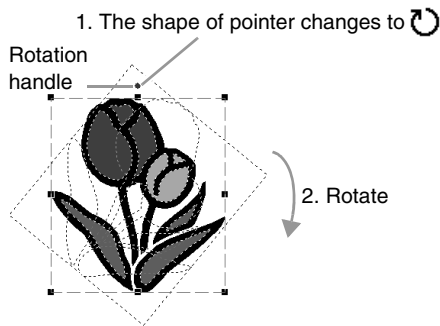

Memo:

To rotate the pattern in 15° increments, hold down the **Shift** key while dragging the handle.

Rotating numerically

1. Select the pattern(s), and then click 1, then 2.

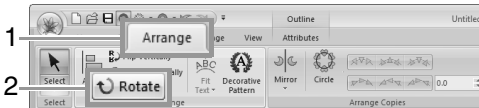

2. Type or select the rotation angle. Click **OK**.

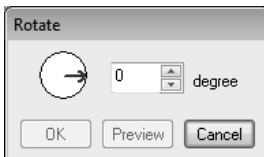

Memo:

An angle can also be selected by dragging  in the **Rotate** dialog box.

Flipping patterns horizontally or vertically

Select the pattern(s), and then click 1, then 2.

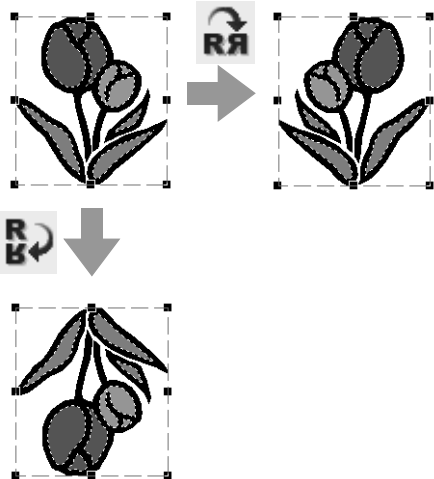

Note:

Some patterns imported from embroidery cards cannot be flipped.

Arrange Copies

Note:

It may not be possible to create mirror copies of some embroidery data read from embroidery cards.

■ Using the Mirror Copy tool

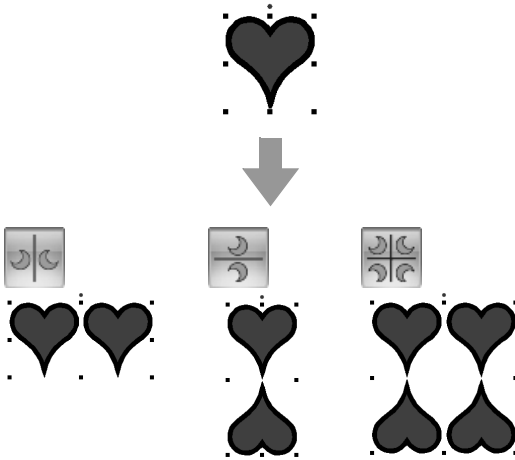

1. Select an embroidery pattern(s), and then click 1, then 2, then 3.

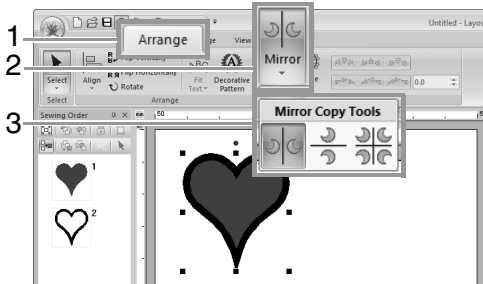

2. Drag the pointer, and then click at the desired location.

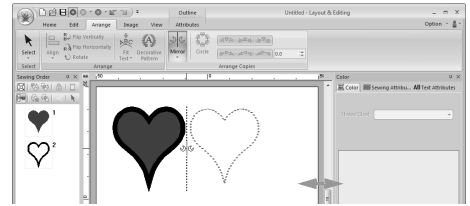

■ Using the Circle Copy tool

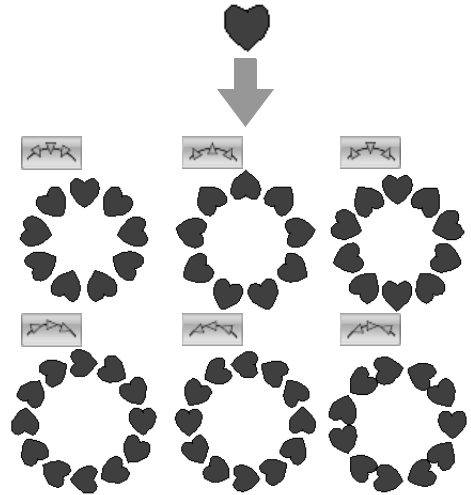

1. Select the embroidery pattern(s), click 1, then 2.

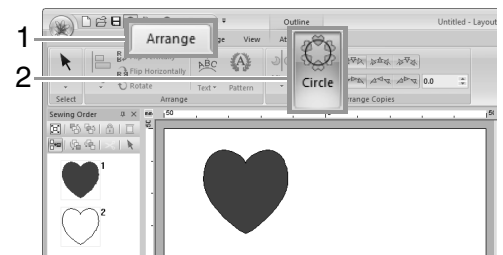

Memo:

- With the patterns at 1, you can select the desired arrangement.
- You can specify the spacing between patterns in (2). The higher the value, the wider the patterns are spaced from each other.



2. Drag the pointer to draw a circle.

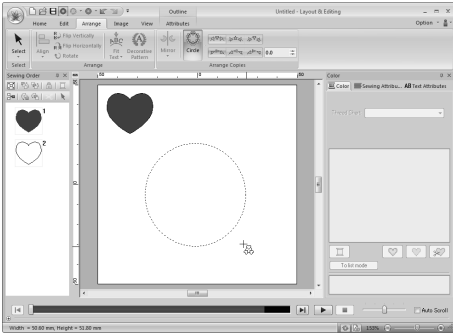

Memo:

- To draw a circle, hold down the **Shift** key while dragging the pointer.
- To redraw the ellipse, right-click the Design Page to return to before the ellipse was drawn.

3. Drag the pointer to select the desired angle.

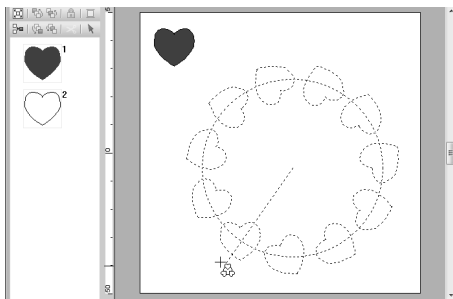
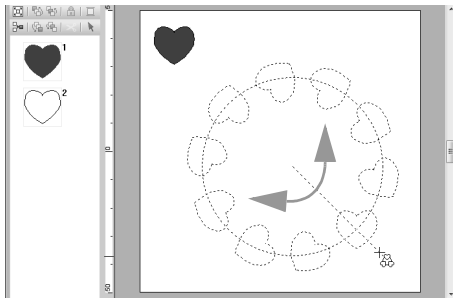

Rotating the line changes the orientation of the patterns.

Memo:

To rotate the line in 15° increments, hold down the **Shift** key while moving the pointer. The angle of the line appears in the status bar.

4. Click to finish the copies.

Adding a decorative pattern

A decorative pattern can be added to selected embroidery pattern.

1. Select the embroidery pattern, and then click 1, then 2.



2. Select a category from the **Category** selector (1), select the desired decorative pattern (2), and then click **OK** (3).

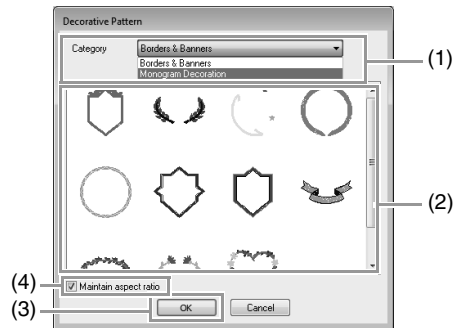

- (4) **Maintain aspect ratio**

When the check box is selected The original width-to-height proportion of the added decorative pattern is maintained.



When the check box is cleared
 The width-to-height proportion of the decorative pattern changes with the width-to-height proportion of the selected embroidery pattern.



Grouping/Ungrouping embroidery patterns

■ Grouping patterns

Select several patterns, and then click **1**, then **2**, then **3**.

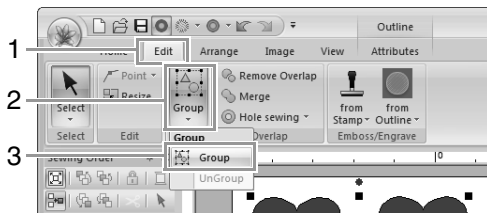

■ Ungrouping patterns

Select a grouped embroidery pattern, and then click **1**, then **2**, then **3**.

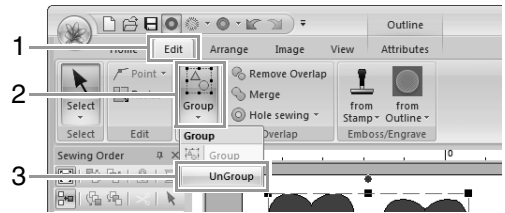

■ Editing grouped patterns individually

Even after patterns are grouped, they can be edited individually.



- 1.** To select a single pattern within a group, hold down the **Alt** key while clicking the pattern.
- 2.** Edit the pattern.

Applying Sewing Attributes to Lines and Regions

Setting the thread color and sew type

The **Sew** group in **Attributes** tab allows you to set the embroidery attributes.

Line sew / Region sew

 switches on/off line sewing,  switches on/off region sewing.



Memo:

When line sewing or region sewing is switched off, it is not sewn (and the color or sew type cannot be selected).

On: The **Line color/Region color** button and the **Line sew type/Region sew type** selector are displayed.

Off: The **Line color/Region color** button and the **Line sew type/Region sew type** selector are not displayed.

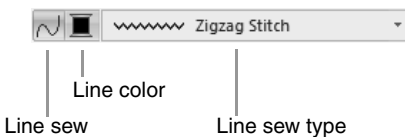

Line sewing on:

Line sewing off:

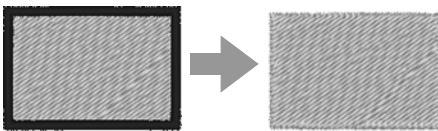

Region sewing on:

Region sewing off:

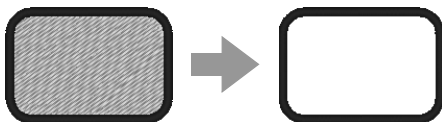

 "Color" on page 56 and "Sew type" on page 57

Color

Click the **Color** button.

- Palette mode

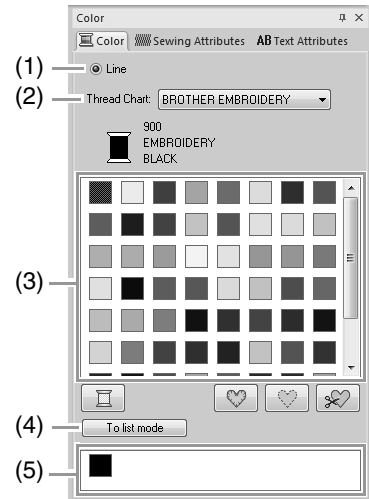

- List mode

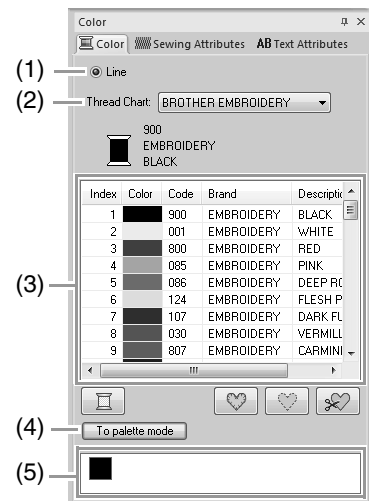

- (1) Select the type of stitching (**Line**, **Region1** or **Region2**) whose color is being selected.

Line: Line color

Region1: Region color

Region2: Additional color for blending



Memo:

Region 2 can only be selected if a gradation with a blending effect is specified.



“Creating a gradation/blending” on page 44

- (2) From the **Thread Chart** selector, select a thread brand or your user thread chart.
- (3) From the list of thread colors, select the desired color.
- (4) Click to switch the mode.
- (5) Displays all thread colors being used in the embroidery design. When an embroidery pattern is selected, a frame appears around the colors used in that pattern. The same thread colors can be specified by selecting them here.

■ **Special colors**

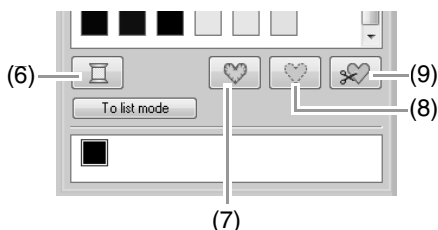

- (6) **NOT DEFINED:** If you want to be able to manually select the color for a monochrome pattern, you can select **NOT DEFINED**.

Colors for creating appliqués:

You can create appliqués using the following three special colors.

- (7) **APPLIQUE MATERIAL:** marks the outline of the region to cut from the appliqué material.
- (8) **APPLIQUE POSITION:** marks the position on the backing material where the appliqué must be sewn.
- (9) **APPLIQUE:** sews the appliqué on the backing material.



Memo:

By using the Applique Wizard, appliqués can easily be created.



“Tutorial 9: Creating Appliqués” on page 153

■ **Sew type**

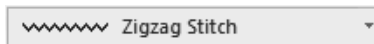

Use these to set the sew type for outlines, inside regions, text, and manual punching patterns.

Click in a sew type selector, and then click the desired sew type.

→ The available settings that appear differ depending on the object that is selected.

Object type	Line sew type settings	Region sew type settings
Text (built-in fonts (025,029), custom fonts)	None	Satin, Fill, Prog. Fill (programmable fill)
Text (built-in fonts (except 025 and 029), monogram fonts, TrueType fonts)	Zigzag, Running, Triple, Motif, Stem, Candlewicking, E/V	
Text (Small font)	None	None
Manual punching pattern	None	Satin, Fill, Prog. Fill (programmable fill), Piping, Motif
Others	Zigzag, Running, Triple, Motif, Stem, Candlewicking, E/V	Satin, Fill, Prog. Fill (programmable fill), Piping, Motif, Cross, Concentric Circle, Radial, Spiral, Stippling



“Line sew / Region sew” on page 56 and “Specifying sewing attributes” on page 58

Specifying sewing attributes

1. Select an embroidery pattern, the Draw tool or the Text tool.
2. Click the **Sewing Attributes** tab.

Beginner mode:

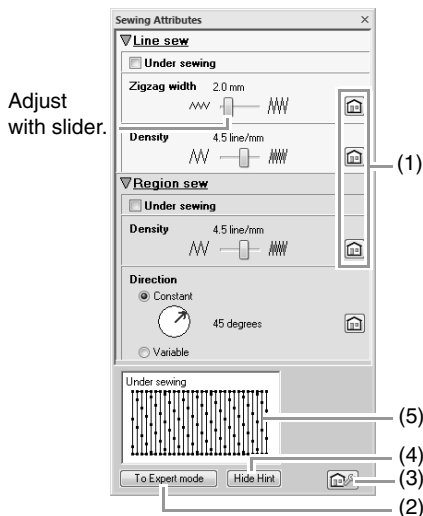

Expert mode:

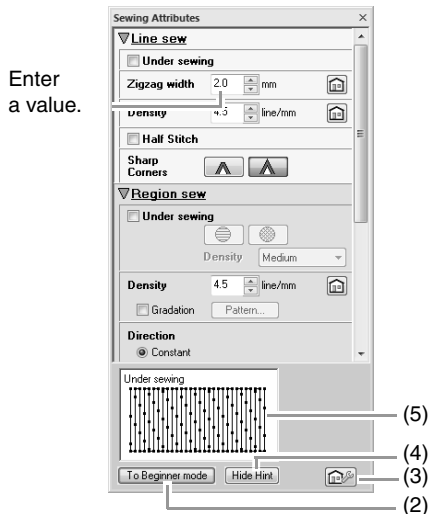

- (1) Click to return to the default setting.
- (2) Click to switch the mode.
- (3) Click to load/save the sewing settings.
- (4) Click to switch between displaying and hiding the hint view.
- (5) Hint view

With each change in the settings, a preview of the stitching can be checked here.



Memo:

The sewing attributes displayed in the dialog box depend on the selected sew type.

3. Change the sewing attributes displayed under **Line sew** or **Region sew**.

→ The settings are applied to the embroidery pattern each time the settings are changed.



For details on the different sewing attributes and settings, refer to "Line sewing attributes" on page 296 and "Region sewing attributes" on page 301.



Memo:

Frequently used sewing attributes can be saved.



For details, refer to "Saving the settings in a list" on page 170

Embossing/Engraving

Multiple patterns can be selected to create an engraved/embossed effect.

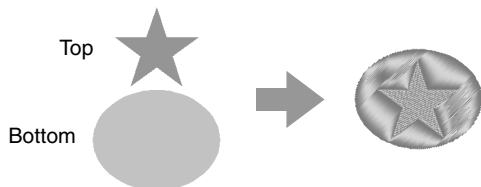

1. Draw a shape.

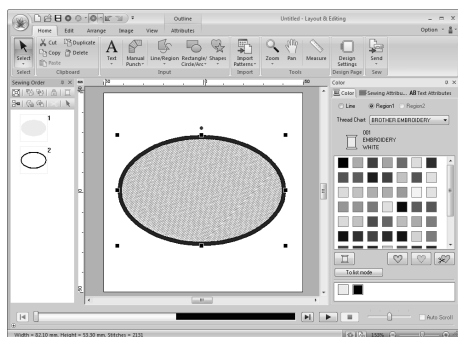

In this example, the fill stitch is selected for region sewing.

2. Draw a shape overlapping the shape drawn in step 1.

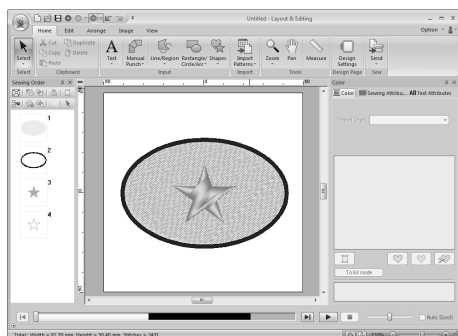

3. Select the two shapes, and then click 1, then 2, then 3.

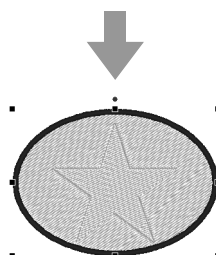
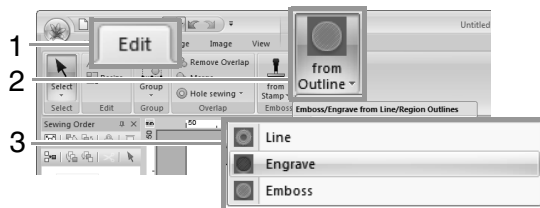

Line

The bottom pattern is engraved with the outline of the shape on top.

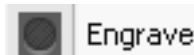
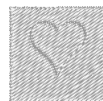

Engrave

An engraving is made in the bottom pattern from the shape on top.

For best result, select Satin Stitch for region sewing of the bottom pattern.

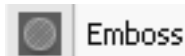

Emboss

An embossing is made in the bottom pattern from the shape on top.

For best result, select Fill Stitch for region sewing of the bottom pattern.

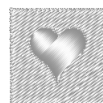

Memo:

This effect can be edited with the Edit Stamp tool.



Note:

- These commands can only be used with patterns created using the Line/Region tools, the Rectangle/Circle/Arc tools and the Shapes tools. They cannot be used with patterns created using the Text tools or the Manual Punch tools.
- The bottom embroidery pattern must have one of the following sew types specified for region sewing.
 - Satin stitch
 - Fill stitch
 - Programmable fill stitch
- In order to use the **Line** command, line sewing must be switched on for the top embroidery patterns.
- In order to use the **Engrave** or **Emboss** commands, region sewing must be switched on for the top embroidery patterns.

Applying and editing stamps

You can create engraved/embossed effects by stamping a shape into a pattern. This appears as stitching sewn in different directions.



■ Applying a stamp

1. Draw a shape.

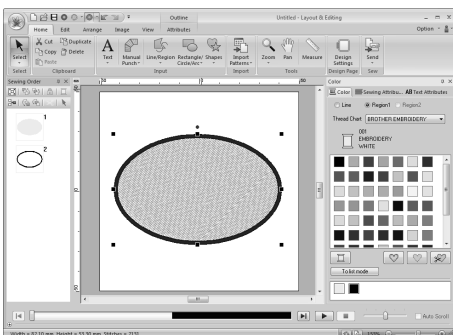

2. Click 1, then 2, then 3.

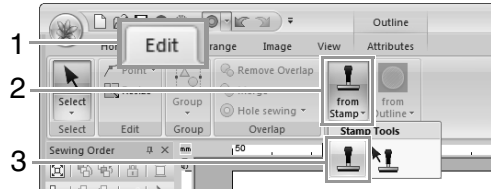

3. Select a stamp pattern (.pas file with stamp settings applied).

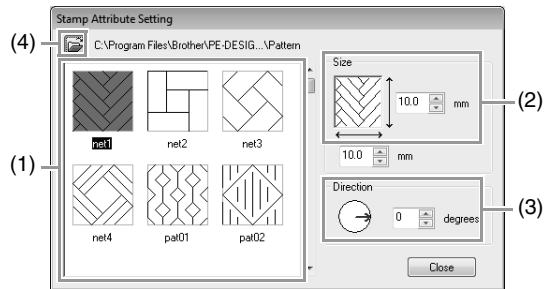

- (1) Select a stamp pattern.
- (2) Specify the size of the stamp pattern.
- (3) Specify the direction of the stamp pattern.
- (4) To select a different folder, click



Memo:

Engraving and embossing stamp settings appear as red- and blue-filled areas.

4. Click the object drawn in step 1 to select it.
 - “Marching lines” appear around the selected object.
5. Click the desired locations within the object.

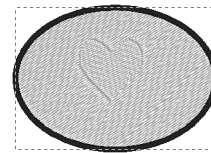

You can preview the effect of the created stamp in Realistic View.



Memo:

- Stamps can be applied to regions of objects that have the satin stitch, fill stitch and programmable fill stitch applied.
- Using Programmable Stitch Creator, you can edit patterns that have been provided or you can create your own.



“Programmable Stitch Creator” on page 229

■ Editing a stamp

1. Click 1, then 2, then 3.

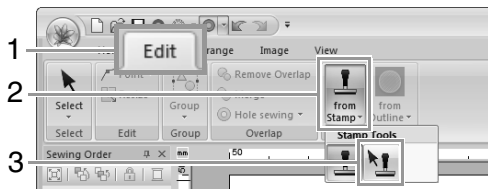

2. Click the object with the stamp.
→ “Marching lines” appear around the selected object.

3. Click the stamp.

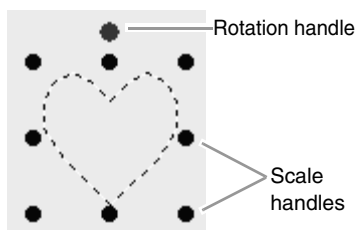

📖 Memo:

- Only one stamp can be selected at a time.
- To enlarge the pattern, drag a scale handle.
- To rotate the pattern, drag the rotation handle.
- To delete the pattern, press the **Delete** key.

4. Edit the stamp.

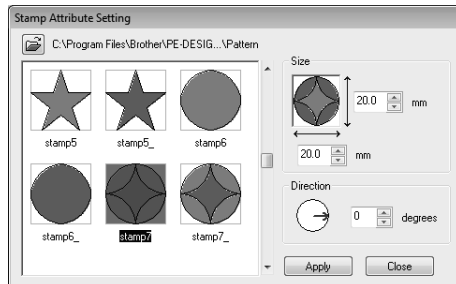

- To change the stamp pattern, select a different pattern, and then click **Apply**.

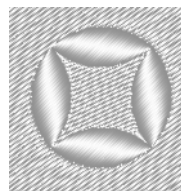

📖 Memo:

- If the size of a pattern is changed, the size of the stamp does not change. Be sure to check the stamp after editing a pattern.
- If a pattern containing a stamp is edited, be sure to check the stamp after editing is finished.

Reshaping Embroidery Patterns

Selecting points

1. Select the Select Point tool by clicking **1**, then **2**, then **3**.

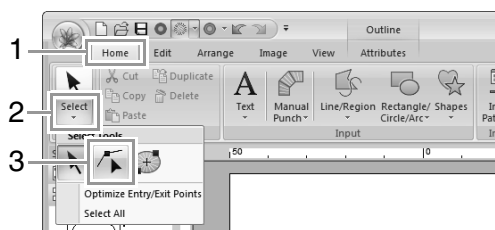

2. Click the pattern.
3. To select a single point, click an empty square.

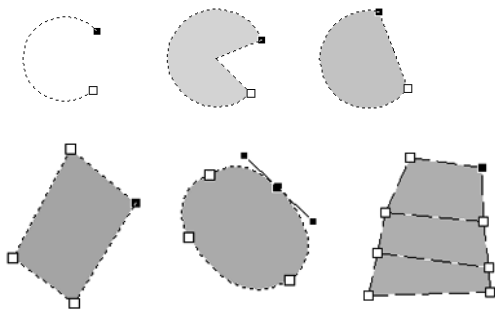

Memo:

The pattern can be a broken line, a curve, an arc, a fan shape, an arc & string, a manual punching pattern, or stitch data.

Memo:

Multiple points can be selected in any of the following ways.

- Drag the pointer.
→ All points within the box are selected.
- Hold down the **(Ctrl)** key while clicking the points.
→ To deselect a point, click the selected point.
- Hold down the **(Shift)** key while pressing an arrow key to select multiple points.
- Hold down the **(Ctrl)** key while pressing an arrow key to change the point that is selected.

Moving points

1. Select the point.
2. Drag the point to the new location.

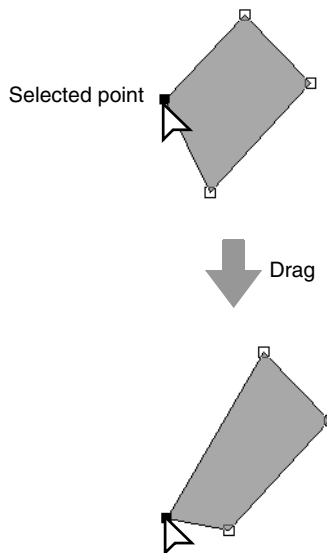

Memo:

- To move the point of a broken line, a curve, a manual punching pattern, or stitch data horizontally or vertically, hold down the **(Shift)** key while dragging it.
- A selected point can also be moved with the arrow keys.
- The arrow keys cannot be used to move the end points of an Arc, Arc & String, and Fan.
- Points in patterns set for hole sewing can also be moved. However, the point cannot be moved to cross an outline. In order to move the point in this way, cancel hole sewing first.
- If you start dragging by clicking elsewhere on the outline of the pattern, a new point will be inserted or the selected point(s) will be deselected.

Inserting points

1. Select the Select Point tool by clicking 1, then 2, then 3.

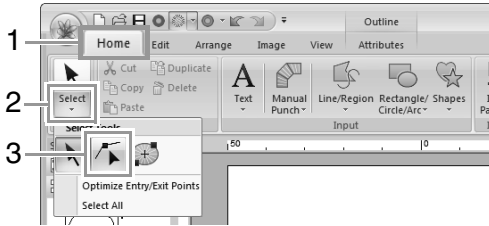

2. Click the pattern.
3. Click the outline to add a point.

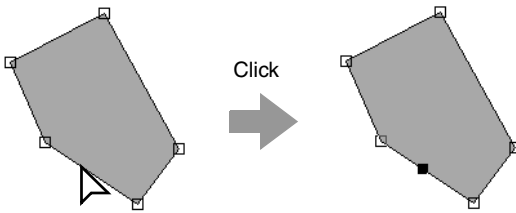

Deleting points

1. Select the point.
2. Click 1, then 2, or press the **Delete** key to remove the point.

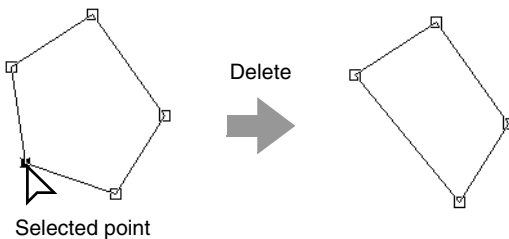
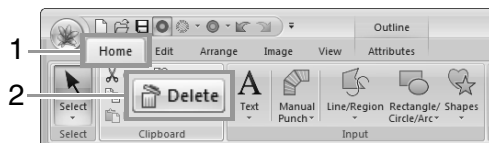

Transforming straight lines into curves or curves into straight lines

1. Select the point.
2. Click 1, then 2, then 3.

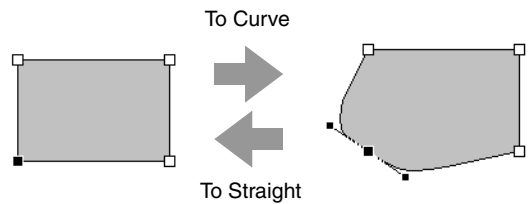
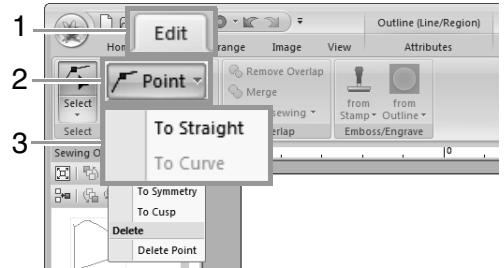

Changing the curve type

1. Select a point on a curve.
2. Click 1, then 2, then 3.

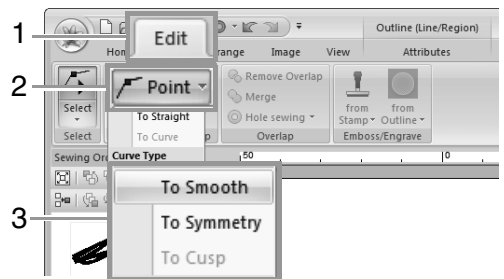

To Smooth

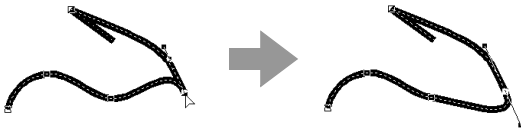

To Symmetry

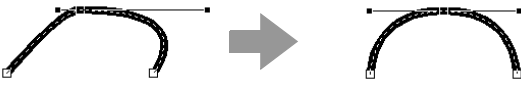

To Cusp

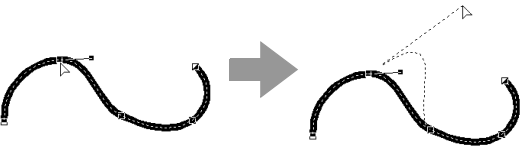

3. Drag the path to adjust it.



Memo:

The shape can be changed by dragging the handles for the point on the curve.

Moving entry/exit points and the center point

Moving the entry/exit points

1. Select the Entry/Exit/Center Point tool by clicking 1, then 2, then 3.

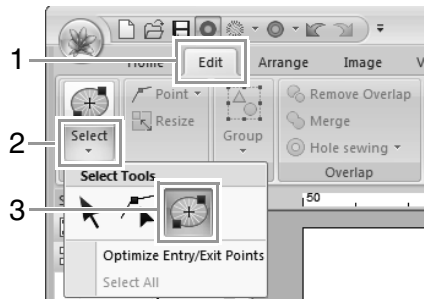

2. Click the object.

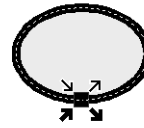

This is the entry point for the outline stitching. The previous pattern is connected to this point.



This is the exit point for the outline stitching. Stitching continues from this point to the next pattern.



This is the entry point for the inside region stitching. The previous pattern is connected to this point.



This is the exit point for the inside region stitching. Stitching continues from this point to the next pattern.

3. Drag the arrow for the point to the desired location on the outline.

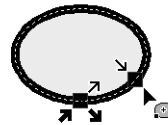

Memo:

- If the outline or the inside region are set to not be sewn, the corresponding point does not appear.
- If the region has the concentric circle stitch or radial stitch applied, the center point of the stitching also appears.



"Moving the center point" on page 65.



Note:

- Only entry and exit points for patterns created with the Circle or Arc, Rectangle and Line/Region tools can be edited. Stitch pattern or patterns created with the Text tools or Manual Punch tools cannot be edited.
- If the entry and exit points have been optimized, the entry and exit points of the patterns cannot be edited. In order to use this tool for editing the entry and exit points, **Optimize Entry/Exit points** must be canceled.

■ Optimizing the entry/exit points

The entry and exit points for the stitching of connected objects with the same color are optimized (in other words, they are connected by the shortest distance possible).

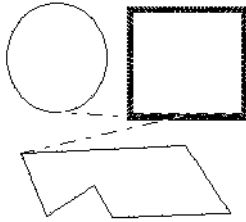

Optimize Entry/Exit points not selected

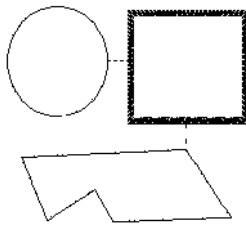

Optimize Entry/Exit points selected

Click 1, then 2, then 3.

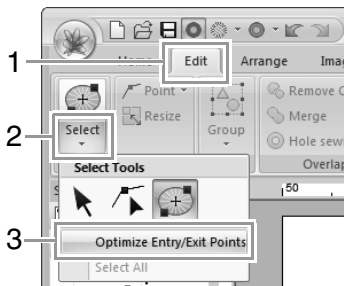

→ A check mark appears beside **Optimize Entry/Exit points**.

! Note:

- Only entry and exit points for patterns created with the Circle or Arc, Rectangle and Line/Region tools can be optimized.
- If **Optimize Entry/Exit points** is applied, all manual adjustments of the entry and exit points will be lost.

📖 Memo:

To cancel optimizing, select this command so that no check mark appears beside **Optimize Entry/Exit points**.

→ If the optimizing of the entry and exit points is cancelled, the entry point and exit point positions are retained.

■ Moving the center point

The center point for regions set to the concentric circle or radial stitch can be repositioned for a more decorative effect.

1. Click 1, then 2, then 3 to select the Entry/Exit/Center Point tool.

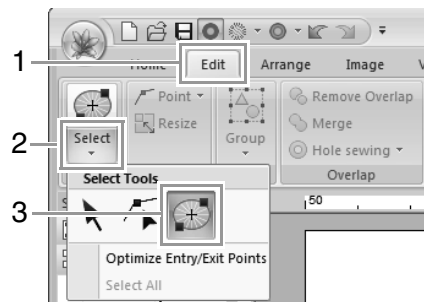

2. Click the region set to the concentric circle or radial stitch.

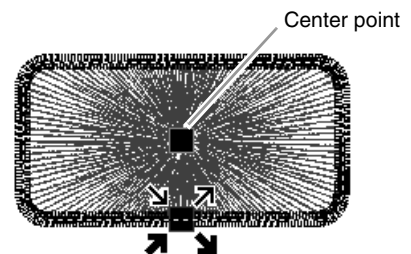

3. Drag the center point to the desired location.

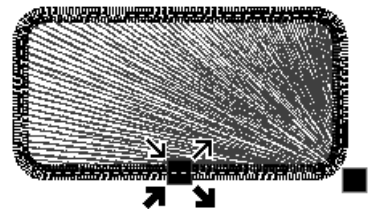

Editing a Stitch Pattern

Converting objects to a stitch pattern

Objects can be converted into a stitch pattern, allowing you to make detailed changes by modifying the position of individual stitches.

Select the pattern(s), and then click **1**, then **2**.

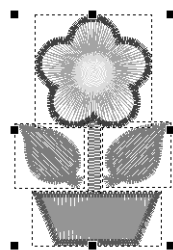
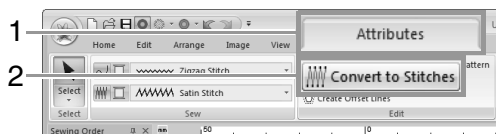

Memo:

- In stitch patterns, stitches appear as solid lines (——), and jump stitches appear as dotted lines (---).
- If any part of grouped objects, objects set for hole sewing, and text arranged on shapes is selected, all objects in the entire group are converted to stitch patterns.
- Patterns that do not have sewing attributes applied are deleted when the object is converted to stitch pattern.
- Object means patterns created with Shape tools or Text tools or Manual Punch tools.

Selecting stitch patterns by thread color

Hold down the **Alt** key and click the thread color for the stitch patterns that you wish to select.

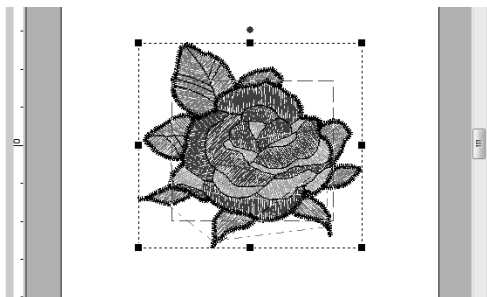

Memo:

- The thread color can be changed when patterns are selected using this method.
- If stitch patterns are grouped, patterns cannot be selected by color using this method.

Selecting stitch points of stitch pattern

1. Select the Select Point tool by clicking **1**, then **2**, then **3**.

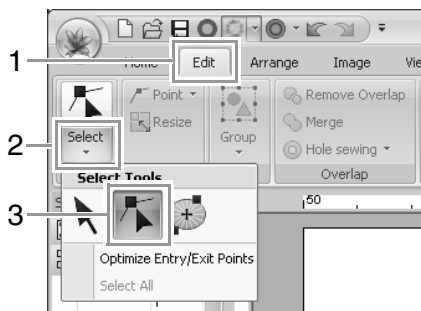

2. Click the stitch pattern.

3. To select a single stitch point, click an empty square.

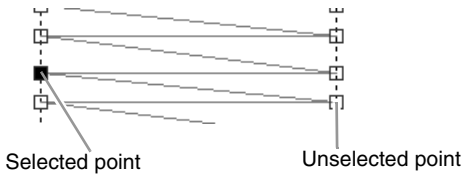

Memo:

- When selecting stitch points, be sure to click the stitch point (do not click a blank area of the Design Page), otherwise all of the selected points will be deselected.
- If you click on a jump stitch, the points at both ends are selected.
- Multiple stitch points can be selected in the same way that embroidery pattern points are selected.

"Selecting points" on page 62.

- Press the **Tab** key.
→ All stitch points in the next color are selected.
- Press the **Shift** and **Tab** keys.
→ All stitch points in the previous color are selected.
- Press the **Ctrl** and **Home** keys.
→ The entry point of the first thread color is selected.
- Press the **Ctrl** and **End** keys.
→ The exit point of the last thread color is selected.
- Select at least one point in a given color, and then press the **Home** key.
→ The entry point of the color is selected.
- Select at least one point in a given color, and then press the **End** key.
→ The exit point of the color is selected.

Note

Stitch points cannot be edited if the pattern is not a stitch pattern. The pattern can be viewed in Solid View.

■ Moving stitch points

Drag the selected stitch points to the new location.

Memo:

Stitch points are moved in the same way that embroidery pattern points are moved.

"Moving points" on page 62.

■ Inserting stitch points

Click a line between two stitch points to add a new point at that position.

■ Deleting stitch points

Press the **Delete** key to delete the selected stitch point.

Memo:

- If the end point of a jump stitch is deleted, that jump stitch segment is deleted and the stitches before and after the jump stitch are connected.
- To insert a stitch point and change the previous line into a jump stitch, hold down the **Ctrl** and **Shift** keys while clicking on the line.

Converting a stitch pattern to blocks

Stitch pattern can be converted into blocks (manual punching data).

"Manually Creating Professional-Level Embroidery Patterns (Manual Punching)" on page 148.

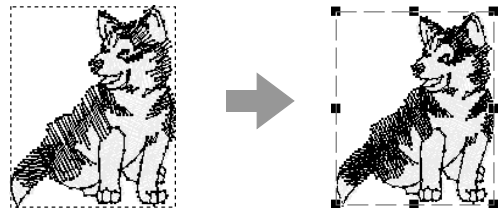

1. Select the stitch pattern(s), and then click 1, then 2.

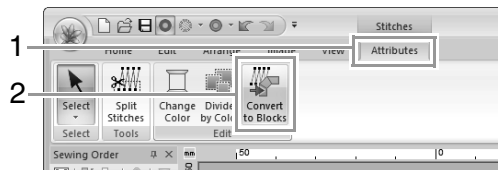

2. Move the slider to select the desired sensitivity. Click **OK**.

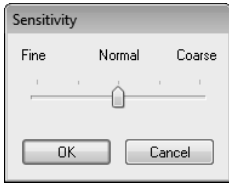

Memo:

The **Normal** setting should provide satisfactory results in most cases, but depending on the complexity of the pattern, you may need to select a setting more towards **Coarse** or **Fine**.

→ The stitch pattern is converted to grouped manual punching data.

☞ "Grouping/Ungrouping embroidery patterns" on page 55.

Note:

The **Stitch to Block** command cannot be used with some stitch pattern imported from embroidery cards.

Splitting off parts of a stitch pattern

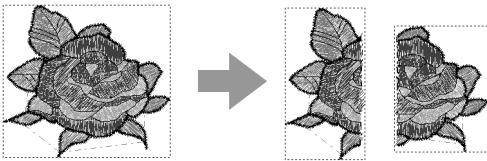

1. Select a stitch pattern, and then click **1**, then **2** to select the Split Stitch tool.

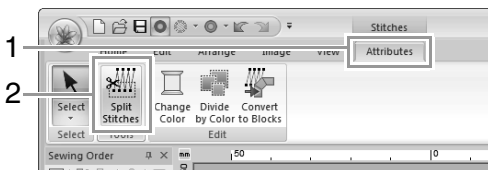

→ All other stitch data disappear from the display.

2. Click in the Design Page at the point where you want to start drawing the enclosing lines.

3. Continue clicking in the Design Page to specify each corner of the enclosure around the area to be cut off.

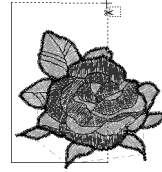

Memo:

To remove the last point that was entered, click the right mouse button.

4. Double-click in the Design Page to specify the section to be split off.

Memo:

The cutoff piece moves to the end of the sewing order.

☞ "Checking and Editing the Sewing Order" on page 73.

Dividing stitch data by color

Before dividing



After dividing



Select the stitch pattern(s), and then click **1**, then **2**.

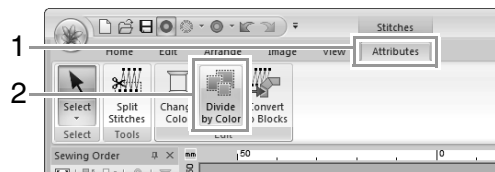

→ Dotted lines appear around each part of the stitch data.

Checking Embroidery Patterns

Zooming

Click 1, then 2, then 3.

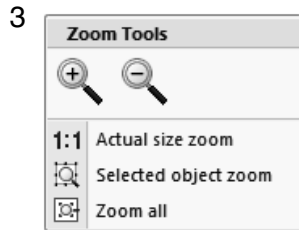

- : Click the Design Page to zoom in.
(Right-click the Design Page to zoom out.)
- : Click the Design Page to zoom out.
(Right-click the Design Page to zoom in.)
- 1:1** : The Design Page is displayed at its actual size.
- : The Design Page is zoomed to display only the selected objects.
- : The entire Design Page is displayed to fit within the window.

Memo:

Zooming is also possible by dragging the Zoom slider in the status bar or clicking the Zoom ratio.

"Layout & Editing Window" on page 19

Using the Pan tool

The part of the work area that is displayed can easily be changed by using the Pan tool.

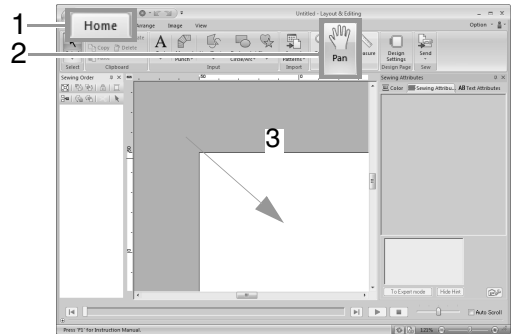

Using the Measure tool

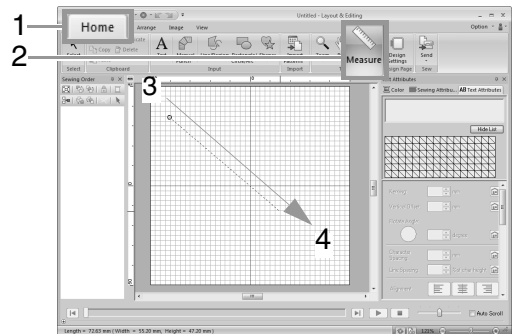

→ The length appears in the status bar.

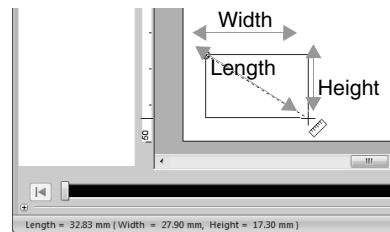



Memo:

When the rulers are displayed, click **mm** / **in.** to switch the measurement units between millimeters and inches.

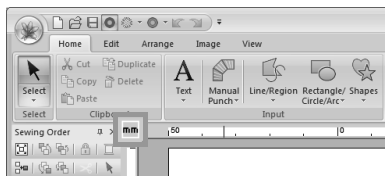

Changing the display of the embroidery design

Click 1, then 2.

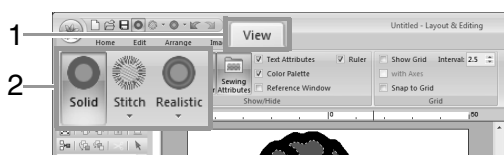

■ Solid View

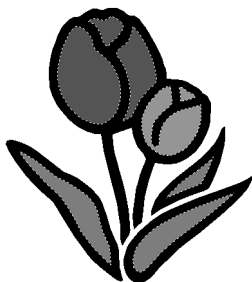

■ Stitch View

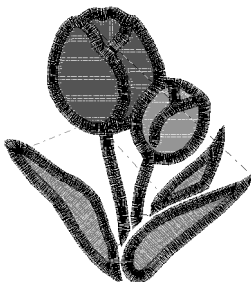

You can display a stitch view of it in order to see how the stitching is connected.



Memo:

If is selected under **Machine Type** in the **Design Setting** dialog box, click 1, then 2, then 3 to view the thread trimming locations in the Design Page.

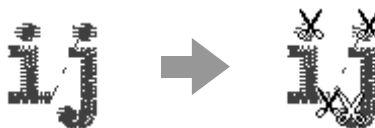

■ Realistic View

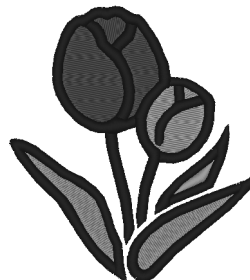

You can display a realistic view of it in order to see how the design will appear once it is sewn.



Memo:

Changing realistic view settings

1. Click 1, then 2, then 3.



2. If necessary, specify settings for **Thread Width** (1), **Contrast** (2) and **Brightness** (3), then click **Apply**.

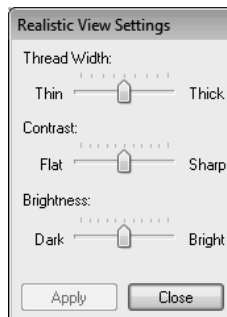

- (1) Thread Width: Thin ————— Thick
- (2) Contrast: Flat ————— Sharp
- (3) Brightness: Dark ————— Bright

Checking the stitching with the Stitch Simulator

1. Click 1, then 2.

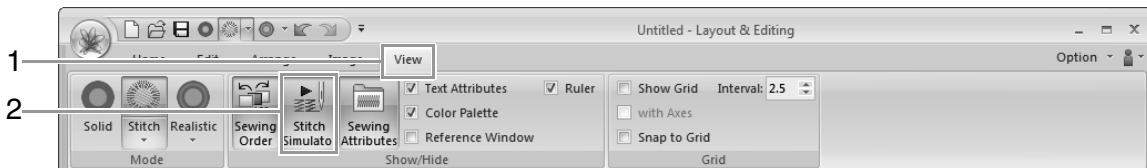

2. Click the buttons to view a simulation of the stitching.

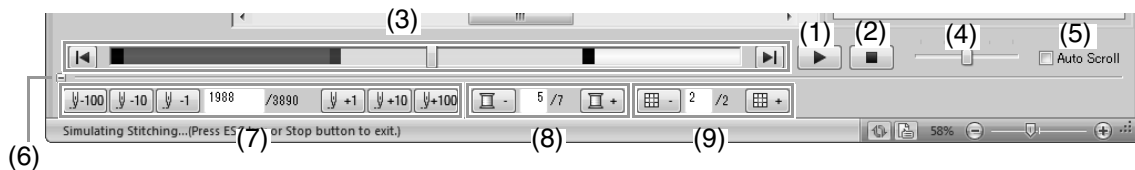

- (1) Starts the stitching simulation. During stitching simulation, this button changes to , which can be clicked to temporarily stop the simulation.

- (2) Stops the simulation and returns to the previous display.

- (3) The slider shows the current location in the simulation. In addition, the slider can be moved to change the position in the simulation.

: Returns to the beginning of stitching and stops the simulation.



: Advances to the end of stitching and stops the simulation.



- (4) Drag the slider to adjust the simulation stitching speed.

- (5) Select this check box to automatically scroll the simulation of the pattern when it is too large to be fully displayed.

- (6) Click to hide the bottom section of the Stitch Simulator. Click  to display it again.

- (7) Shows the number of the current stitch/total number of stitches.

  : Reverses the simulation by the indicated number of stitches.

  : Advances the simulation by the indicated number of stitches.

- (8) Shows the number of the color being drawn/total number of colors used.

: Returns to the beginning of stitching for the current or previous thread color.

: Advances to the beginning of stitching for the next color.

- (9) Shows the currently displayed pattern section/total number of hoop sections in the pattern. (Appears only for split embroidery patterns.)

: Returns to the beginning of stitching in the current or previous hoop section.

: Advances to the beginning of the design in the next hoop section.

Memo:

- The **Zoom tools**, **Pan tool** and **Measure tool** can be used while a simulation is being viewed. If any other command is selected, the simulation stops.
- If a value is entered at (7), (8) or (9), the simulation is reversed/advanced to the indicated location.

Note:

- If a pattern was selected when the stitching simulation was started, only the selected pattern is drawn in the simulation.
- The **Auto Scroll** check box is not available in Realistic View.

Viewing design in the Reference Window

Click 1, then 2.

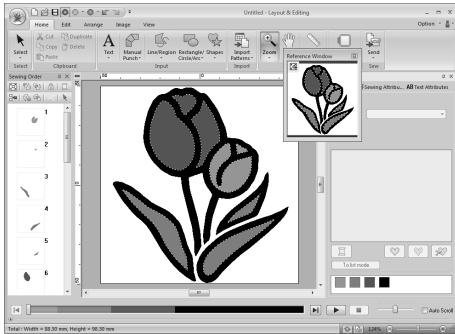

The display area (red rectangle) indicates the part of the pattern displayed in the Design Page.

Zooming

The Reference Window can be switched to display either the entire Design Page or only the embroidery pattern.

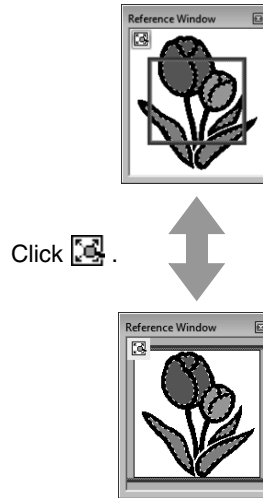
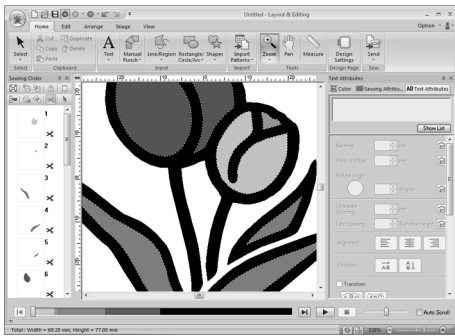

Moving/Resizing the display area frame

The part of the design displayed in the Design Page can be selected from the Reference Window.

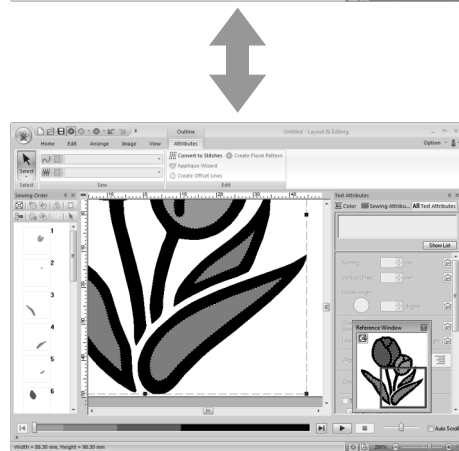
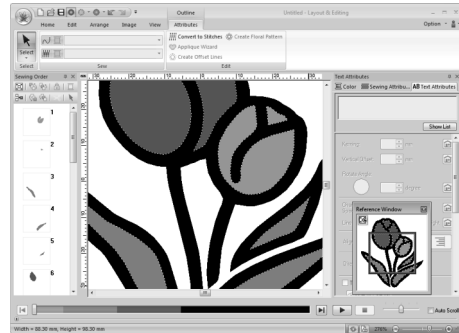

■ Redrawing the display area frame

Instead of moving the display area frame, the frame can be redrawn to display the desired part of the pattern in the Design Page.

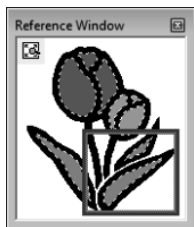
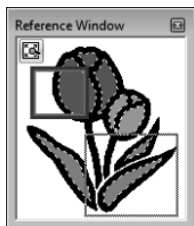

Checking and Editing the Sewing Order

Click 1, then 2.

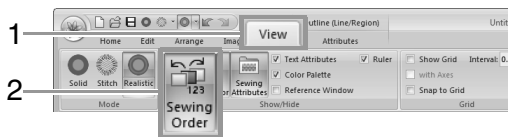

 :Click to enlarge each pattern to fill its frame.





 :Click to display in one frame all patterns of the same color that will be sewn together.





Memo:

When multiple same color patterns are combined into one

frame,  appears to the left of that frame.

Click  to display the combined same color patterns in separate frames.

 appears under the first frame, and each frame is displayed with a subnumber following the first, to indicate its sewing order within the patterns of the same color.

Click  to recombine all of the same color patterns back into one frame.



■ Selecting a pattern

1. Click a frame containing the pattern in the Sewing Order pane.

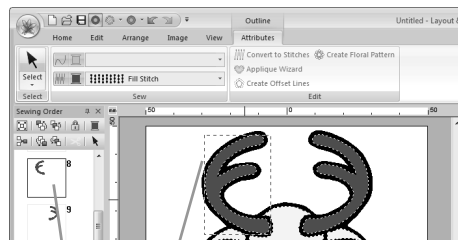

Blue line

Marching line

Memo:

- To select multiple patterns, hold down the **Shift** or **Ctrl** key while clicking the frames for the desired patterns. In addition, multiple frames can be selected by dragging the pointer over them.

2. Click  at the top of the Sewing Order pane to select the pattern in the Design Page corresponding to the frame selected in the Sewing Order pane. The pattern can also be selected by double-clicking its frame in the Sewing Order pane.

■ Editing the sewing order

The sewing order can be changed by selecting the frame containing the pattern, then dragging the frame to the new location. A red line appears, indicating the position where the frame is being moved.

An alternative method for moving the frames is by clicking the buttons at the top of the Sewing Order pane.

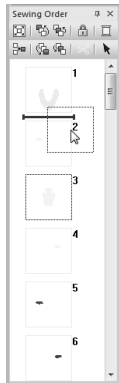

:Click to move the selected pattern to the beginning of the sewing order.



:Click to move the selected pattern ahead one position in the sewing order.



:Click to move the selected pattern back one position in the sewing order.



:Click to move the selected pattern to the end of the sewing order.



Note:

Check the stitching after changing the sewing order to be sure that overlapping patterns will not be sewn in the wrong order.

■ Changing colors

1. Select one or more frames in the **Sewing Order** pane, and then click  at the top of the **Sewing Order** pane.

→ The Color pane appears in front of the other panes.

2. Click the desired color in the **Color** pane.

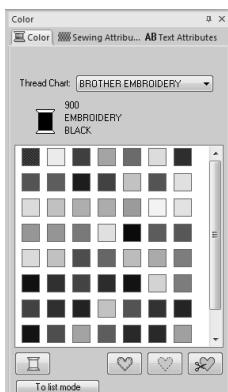

“Color” on page 56.

■ Changing sewing attributes

1. Select one or more frames in the **Sewing Order** pane, and then click the **Sewing Attributes** tab. If the **Sewing Attributes** tab is not displayed, click **View** tab in the Ribbon, then **Sewing Attributes**.

If the sew type selector does not appear in the Ribbon, click the **Attributes** tab of the Ribbon.



2. Change the sewing attributes and sew type.



“Sew type” on page 57 and “Specifying sewing attributes” are on page 58



■ Locking embroidery patterns

Embroidery patterns can be locked to prevent them from being moved or deleted. Locked embroidery patterns cannot be selected or edited.

1. Select one or more patterns in the **Sewing Order** pane, and then click  at the top of the **Sewing Order** pane.
2. Click  at the top of the **Sewing Order** pane.



Memo:

- Frames with  contain multiple patterns of the same color. If these frames are selected to be locked, all patterns in the frame are locked.
-  appears if the lock setting is not the same for all patterns in a frame with  beside it.
- Locking either the line or region of an embroidery pattern made up of an outline and inside region locks the entire embroidery pattern.
- Locking any part of a combined pattern, such as grouped patterns, text arranged on a curve or patterns with hole sewing specified, locks the entire embroidery pattern.

Jump Stitch Trimming

The Jump Stitch Trimming function can be turned on or off.

Note:

These settings are applied only when embroidering with our multi-needle embroidery machines. Before these settings can be specified, select  under **Machine Type** in the **Design Setting** dialog box.



 "Specifying the Design Page Size and Color" on page 85

The Jump Stitch Trimming button () is available in the **Sewing Order** pane.

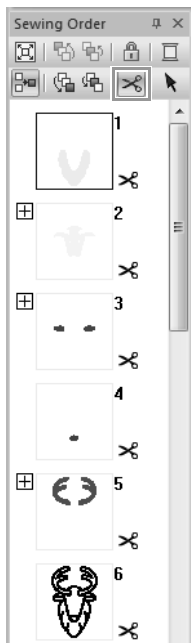
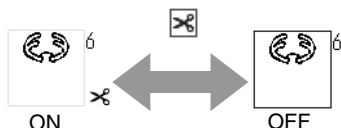
Select a frame, and then click



Memo:

-  appears if the thread trimming setting is not the same for all patterns in a frame with  beside it.
- The thread is cut before the thread color is changed, even if **Jump Stitch Trimming** has been turned off for the frame.
- Click 1, then 2, then 3 to view the thread trimming locations in the Design Page.

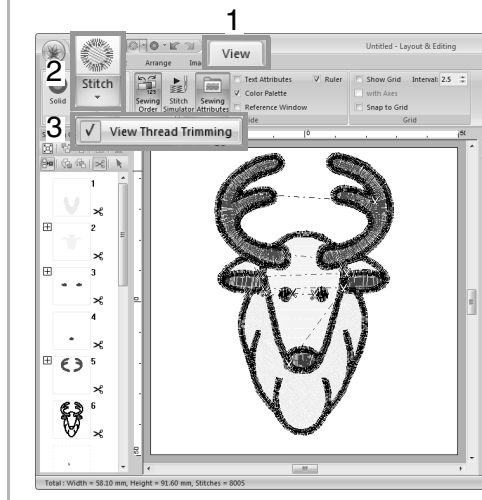

About Minimum jump stitch length for thread trimming

- The jump stitch length can be specified on the **Output** tab into the **Design Settings** Dialog. (To displayed it, click **Home** tab in the Ribbon, then **Design Setting**).

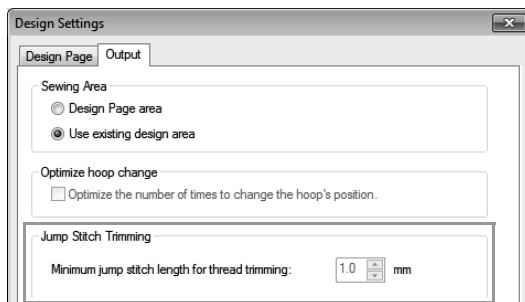

- If the jump stitch length is less than the length specified for **Minimum jump stitch length for thread trimming**, the thread will not be cut, even if **Jump Stitch Trimming** has been set.
- Whether or not **Minimum jump stitch length for thread trimming** is available differs depending on the selected machine model. For details, refer to the Operation Manual for the machine.



Memo:

The default setting can be specified for whether or not thread trimming is applied to objects that are created.

Click **Option** above the Ribbon, and then click **Options** to display the **Options** dialog box. Next, click **Jump Stitch Trimming**, and then select or clear the **Add jump stitch trimming to the entered patterns.** check box.



"Adding jump stitch trimming to new patterns" on page 275

Checking embroidery design information

Click 1.

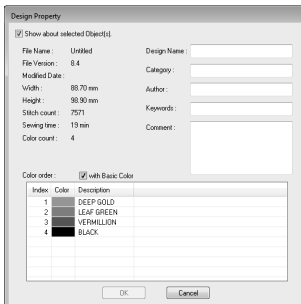
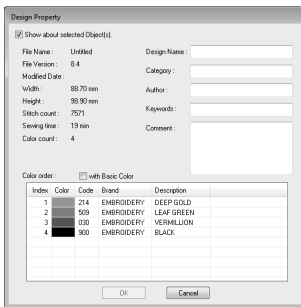

You can enter comments and information about the pattern to a saved .pes file.



Memo:

- You can select and check the properties of individual patterns within the embroidery design by selecting the pattern before opening this dialog box. In this case, clearing the **Show about selected Object(s)** check box switches the dialog box to display properties for all patterns in the Design Page.
- To display the colors as the machine's preset color names, select the **with Basic Color** check box.
- If the Design Page was set to **Custom Size** or **Hoop Size** was set to a multi-position hoop (100 x 172 mm or 130 x 300 mm) or the jumbo frame (360 x 360 mm), a **Design Property** dialog box appears with the sewing information for each hoop of the pattern in the Design Page.

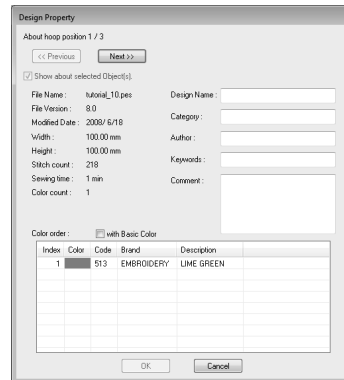

- Files can be searched for in Design Database according to the entered information.

Opening/Importing Embroidery Designs

Creating a new embroidery design

Click 1, then 2.

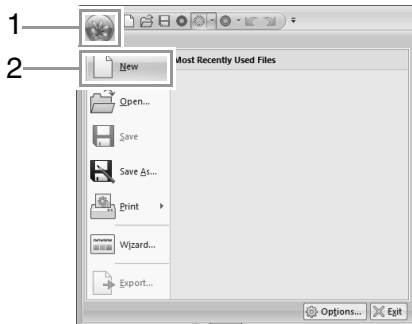

Memo:

The size of the Design Page can be changed.



"Specifying the Design Page Size and Color" on page 85

Opening a Layout & Editing file

1. Click 1, then 2.

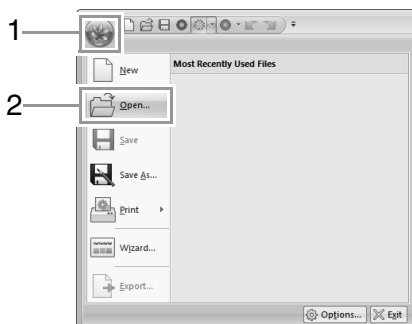

2. Select the drive, the folder and the file, and then click **Open**, or double-click the file's icon.

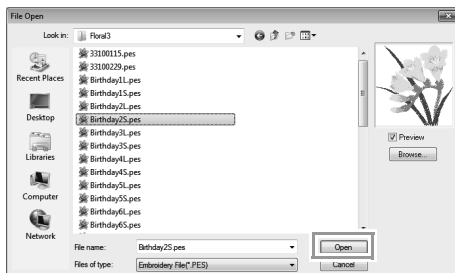

Memo:

- To view the data in the selected folder as thumbnails in the **Browse** dialog box, click **Browse**.

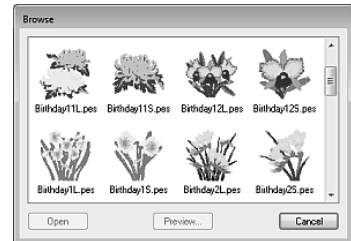

To see a more detailed design, select a file, and then click **Preview**.



- To open the displayed file, click **Open**.
- If no files are listed, there are no .pes files in the selected folder. Select a folder containing a .pes file.
- If the selected file is in a format other than the .pes format, the message "Unexpected file format" appears in the **Preview** box.

Memo:

A file can be opened in any of the following ways.

- Drag the embroidery design from file Windows Explorer into the Layout & Editing window.
- Double-click the embroidery design file in Windows Explorer.
- Double-click the embroidery design file in Design Database.

Memo:

Multiple files can be opened in Layout & Editing. In addition, data can be copied and pasted between files that are open at the same time.

Importing embroidery designs

■ From Design Library

1. Click 1, then 2, then 3.

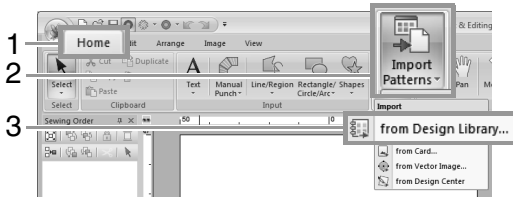

2. From the **Category** selector, select a category to display the corresponding embroidery data.

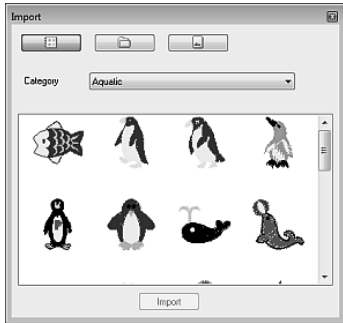

3. Select the file icon for the design to be imported, and then click **Import**, or double click the file icon.

Memo:

- The design can be imported by dragging its file icon from the **Import** dialog box to the Design Page.
- Multiple files cannot be selected to be imported at the same time.
- With the buttons at the top of the **Import** dialog box, change the location from where the file is to be imported.



4. Click to close it.

■ From a folder

1. Click 1, then 2, then 3.

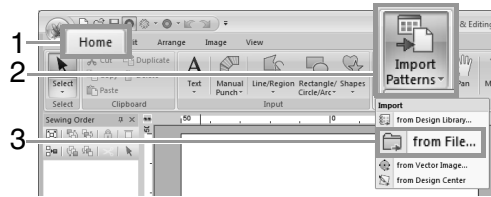

2. Click .

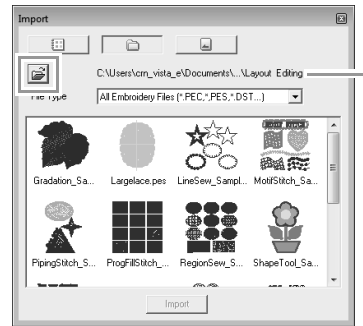

Indicates the path to the currently selected folder.

3. Select a folder, and then click **OK**.

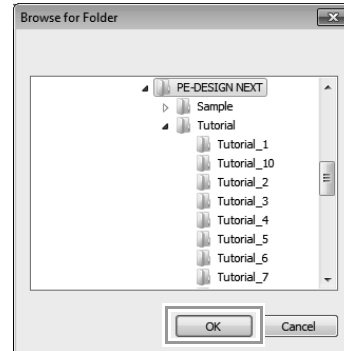

4. From the **File Type** box, select a file name extension to display the corresponding embroidery data.
5. Select the file icon, and then click **Import**. The file is imported.

Note:

When importing designs from other vendors, be sure to choose a design that will fit in the Design Page.

 **Memo:**

Since .dst files do not contain thread color information, the colors of an imported .dst file may not appear as expected. You can change the thread colors by using functions in the **Sewing Order** pane or by holding down the **Alt** key and selecting a stitch pattern.

 "Selecting stitch patterns by thread color" on page 66

- When importing .dst files, the number of jump stitches for thread trimming can be specified.

 "Specifying the number of jumps in embroidery design of the DST format" on page 274

From an embroidery card

1. Insert an embroidery card into the USB card writer module.

 Refer to "Transferring to a machine by using an original card" on page 174

2. Click 1, then 2, then 3.

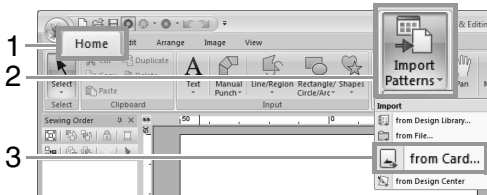

→ After the card has been read, the embroidery designs on the card are displayed.

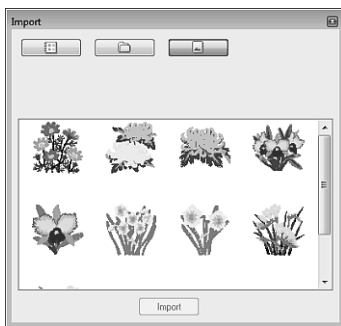

3. Select the file icon, and then click **Import**. The file is imported.

 **Note:**

Due to copyright issues, some embroidery cards cannot be used with this function.

Importing vector images (WMF)

An vector image data in the Windows Metafile (.wmf) file can be converted to an embroidery pattern.

1. Click 1, then 2, then 3.

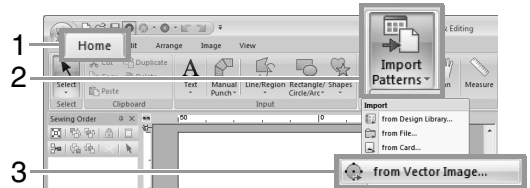

2. Select the drive, folder and file, and then click **Open**.

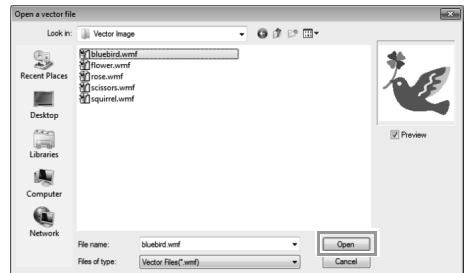

→ The imported image appears in the Design Page.

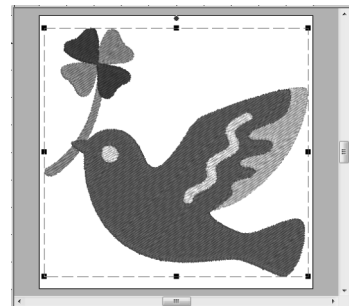

 **Note:**

Not all WMF data files may be imported.

Importing embroidery design from Design Center

1. Start up Design Center and open the file.
☞ *“Original Image Stage” on page 185 and “Opening a file” on page 195.*
2. Click 1, then 2, then 3.

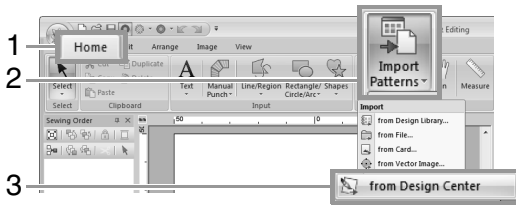

3. Specify the desired settings beside **Magnification** and **Orientation**, and then click **Import**.

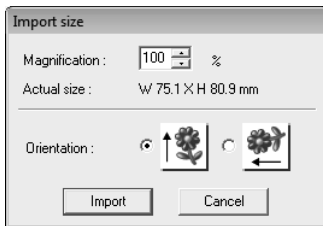

Note:

The maximum magnification ratio that can be specified is the ratio that enlarges the design to the size of the Design Page.

Saving and Printing

Saving

Overwriting

Click 1, then 2.



Memo:

If no file name has been specified or if the file cannot be found, the **Save As** dialog box appears.

Saving with a new name

1. Click 1, then 2.



2. Select the drive and the folder, and then type in the file name.

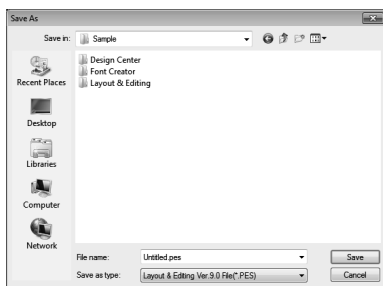

Note:

If you select a file type of a previous software version, saved .pes files can be opened with that version of the software; however, all saved designs will be converted to stitch pattern.

3. Click **Save** to save the data.

→ The new file name appears in the title bar of the Layout & Editing window.

Outputting design in a different format

The data shown in the Design Page can be exported as a file of a different format (.dst, .hus, .exp, .pcs, .vip, .sew, .jef, .csd, .xxx, and .shv).

1. Click 1, then 2



2. Select the drive and the folder, and then type in the file name.

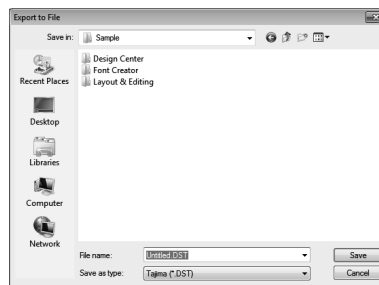

3. Select a format (.dst, .hus, .exp, .pcs, .vip, .sew, .jef, .csd, .xxx, or .shv) that the file will be exported as.



Memo:

The **Number of jumps for trim** setting can be specified for outputting to the .dst format. Before outputting, click the **Option** button, then **Options**, then **DST Settings** to specify the settings.



“Specifying the number of jumps in embroidery design of the DST format” on page 274



Note:

- Some patterns imported from embroidery cards cannot be exported.
- Divided embroidery patterns and embroidery patterns for the jumbo frame or multi-position hoop will be exported as a single file, and will not be split into sections.

Printing

■ Specifying print settings

Before printing, you may need to change the print settings for the embroidery design files.

1. Click 1, then 2, then 3.

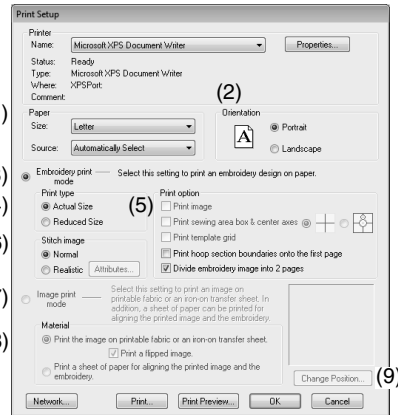

- (1) Specify the paper size.
- (2) Specify the paper orientation.
- (3) To print the embroidery pattern, select **Embroidery print mode**.
- (4) **Print type**

Actual Size:

Select this option to print the design at actual size and the sewing information (dimensions of the embroidery pattern, sewing color order, stitch count and hoop position) on separate pages.

Reduced Size:

Select this option to print a reduced image together with all of the above-mentioned information on a single page.

- (5) **Print option**

Print image:

Select this check box to print the image imported into the Design Page in addition to the embroidery pattern. However, any part of the image extending out of the print area for the embroidery will not be printed.

Print sewing area box & center axes:

(This setting is only available when **Actual Size** is selected.)



: Select this option to print black lines to indicate the sewing area (refer to “Specifying the sewing area” on page 86) and the center axes for the data.



: Select this option to print an embroidery positioning mark in the center of the axes.

(This setting cannot be selected if **Jumbo Frame** has been selected as the Design Page size.)

Print template grid:

Select this check box to print green lines to represent the grid printed on the embroidery sheet included with the hoop. (This setting cannot be selected if **User Hoop**, **Cap Frame**, **Cylinder Frame**, **Jumbo Frame** or **Round Frame** has been selected as the Design Page size.)





Print hoop section boundaries onto the first page:

Select this check box to print the sections of a design where the Design Page has been set to a custom size or to **Jumbo Frame**. The pattern sections are printed in red.

Divide embroidery image into 2 pages:

Select this check box to print at actual size and on A4- or Letter-size paper a design that is larger than the paper size by dividing it in two and printing each half on different pages.

(This setting is only available when **Actual size** is selected in the **Print Setup** dialog box and when the Design Page is set to the larger hoop sizes. This setting is not available if a **User Hoop** size is selected.)

With this split printing feature,  /  or  /  is printed in the lower-right corner of the paper to indicate which half is printed.

(6) Stitch image**Normal:**

Select this option to print the design as lines and dots.

Realistic:

Select this option to print a realistic image of the design. To change the settings of the realistic image, click **Attributes**.



"Changing realistic view settings" on page 70

 **Note:**

If the **Divide embroidery image into 2 pages** check box is cleared and you print on paper of a larger size, the design does not print in two halves. Likewise, if you print on paper of a smaller size, the design might be cut off.

(7) When printing an imported image onto iron-on paper or printable fabric, or when printing the sheet for positioning the embroidery in the printed image, select **Image print mode**, and then select an option under **Material**.

(8) Material**Print the image on printable fabric or an iron-on transfer sheet:**

Select this option to print the background image on iron-on paper or fabric that can be printed on. Only the image is printed.

Print a flipped image:

Select this check box to print the image flipped on a vertical axis. When printing on iron-on paper, the image is normally printed flipped (mirror image). (For details, refer to the instructions for the iron-on paper that you are using.)

Select this option if your printer does not have a function for printing a flipped (mirror) image. (For details, refer to the instructions for your printer.)

Print a sheet of paper for aligning the printed image and the embroidery:

Select this option to print a sheet for aligning the positions of the image and embroidery. Positioning marks and guide lines indicating the embroidering area are printed on the image.

(9) Change Position:

The position where the image is printed on the paper can be changed. (Any part of the image extending out of the print area of the paper is not printed.) Click **Change Position** to display the **Image Print Position Setting** dialog box, and then drag the image to the desired printing position in the paper.

2. Click **OK**.

 "Changing the display of the embroidery design" on page 70.

 **Memo:**

With embroidery patterns for the jumbo frame:
The pattern in Side 2 of an embroidery pattern for the jumbo frame is printed with the orientation of the actual embroidery (rotated 180°).

■ Checking a print image

You can preview the contents of the Design Page before printing.

1. Click **1**, then **2**, then **3**.

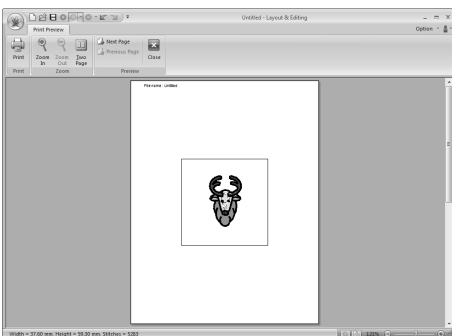

 **Memo:**

*The print image can also be displayed by clicking **Print Preview** in the **Print Setup** dialog box.*

■ Printing a Design Page with sewing information

You can print the Design Page together with its sewing information.

1. Click **1**, then **2**, then **3**.

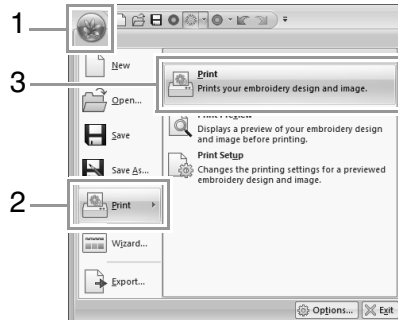

2. Select the necessary settings.

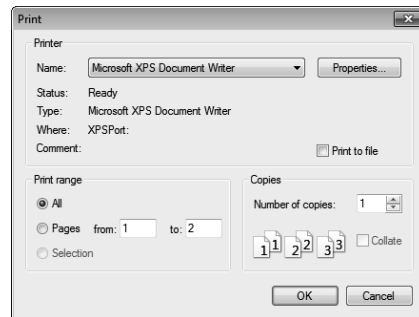

3. Click **OK** to begin printing.

4. Follow the instructions for the printer to finish printing.

Specifying the Design Page Size and Color

The color and size of the Design Page can be changed. You can select a Design Page size according to the size of hoop that you will be using with your embroidery machine. You can also specify a custom size for the Design Page for embroidery patterns that will be split and embroidered in multiple sections.

1. Click **1**, then **2**.

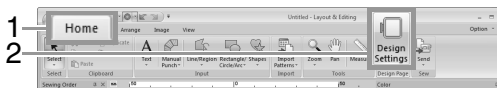

2. Specify the settings for the Design Page, and then click OK.

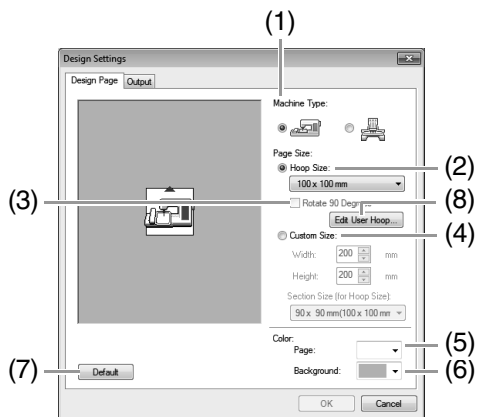

- (1) **Machine Type:**
Select your machine type. The settings available in the **Page Size** selector differ depending on the selected machine type.
- (2) **Hoop Size:**
Select the desired hoop size from the selector.
- (3) **Rotate 90 Degrees:**
Select this check box to arrange the pattern in a Design Page rotated 90°.
- (4) **Custom Size:**
Specify a custom size for split embroidery patterns.
Select this option, and then type or select the desired width and height for the Design Page.

"Tutorial 10-1: Creating Split Embroidery Designs" on page 155.

- (5) **Page:**
Select the desired color for the Design Page.
- (6) **Background:**
Select the desired color for the work area.
- (7) **Default:**
To return to the default settings, click this button.

- (8) **Edit User Hoop:**

Click this button to display the **User Hoop Settings** dialog box, where a user hoop size can be added. The added user hoop size appears at the bottom of the list.

"Specifying a user hoop size" on page 86

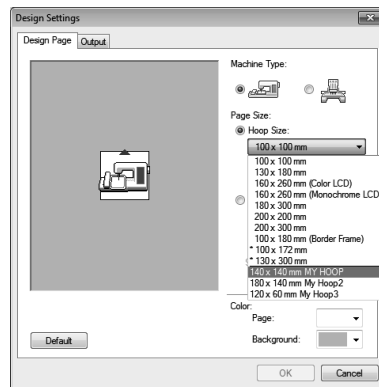

Note:

- The Design Page sizes **130 × 300 mm**, **100 × 172 mm** indicated by the "*", are used to embroider multi-position designs using a special embroidery hoop attached to the embroidery machine at three installation positions.

"Tutorial 10-2: Creating Design for Multi-Position Hoops" on page 161

- Do not select a hoop size larger than the embroidery hoop that can be used with your machine.
- When Cap Frame, Cylinder Frame or Round Frame has been selected, the Design Page cannot be rotated 90°.

Specifying a user hoop size

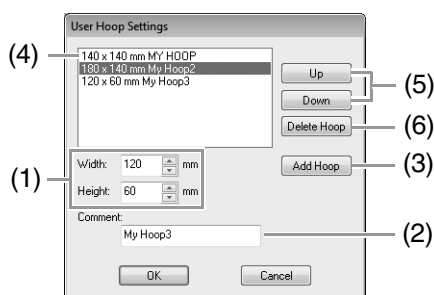

- (1) **Width, Height:**
Type in the size of the hoop to be added.
- (2) **Comment:**
If text was entered in this box, that text appears beside the size.
- (3) **Add Hoop:**
Click this button to add the hoop size.
- (4) **User Hoop List:**
The added hoop size appears in the list. Select a hoop size in this list to change the display order or to delete it.
- (5) **Up, Down:**
Click these buttons to move the selected hoop size up or down in the display order.
- (6) **Delete Hoop:**
Click this button to delete the selected hoop size.

Note:

- A User Hoop cannot rotate 90°.
- A User Hoop cannot be added to the Section Size (for Hoop Size) selector under Custom Size.
- Do not create a Custom Hoop larger than the embroidery hoop that can be used with your machine.
- Embroidery data created in a User Hoop cannot be saved in a format for a previous version.

Specifying the sewing area

The sewing area can be specified.

Click 1.

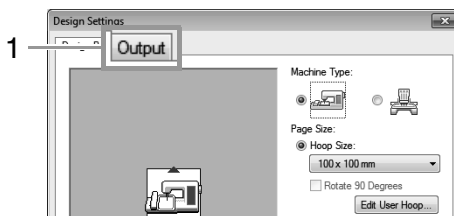

Select the desired sewing area (**Design Page area** or **Use existing design area**).

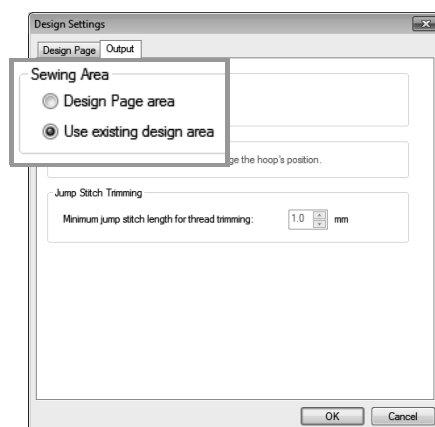

Design Page area: The patterns will be sewn so that the needle position when you start sewing is aligned with the center of your Design Page.

Memo:

When **Design Page area** is selected, the dimension of the pattern matches the size of the Design Page, therefore reducing the ability to move a pattern around the layout screen of your embroidering machine.

Use existing design area: The patterns will be sewn so that the needle position when you start sewing is aligned with the center of the actual patterns.

Memo:

When **Use existing design area** is selected, the actual pattern size is maintained, therefore allowing greater mobility when using the layout functions of your embroidering machine.

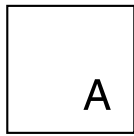

Design Page (on your screen)

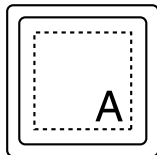

Sewing area = Design Page area

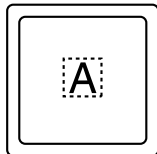

Sewing area = Use existing design area

Note:

This setting cannot be selected if a Jumbo Frame, multi-position hoop or Custom Size has been selected as the Design Page size.

Optimize hoop change

This setting can be selected if a multi-position hoop (100 × 172 mm or 130 × 300 mm) has been selected as the Design Page size.

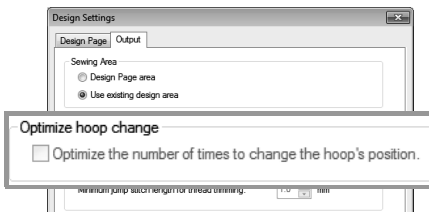

Select the check box to optimize the sewing order/ order of hoop position changes so that the number of times that the hoop position is changed is reduced to the minimum.

This reduces the risk of misalignment in the embroidery pattern or uneven stitching from changing the hoop position too often.

Jump Stitch Trimming

These settings are applied only when embroidering with our multi-needle embroidery machines. Before these settings can be specified, select  under **Machine Type** in the **Design Setting** dialog box.

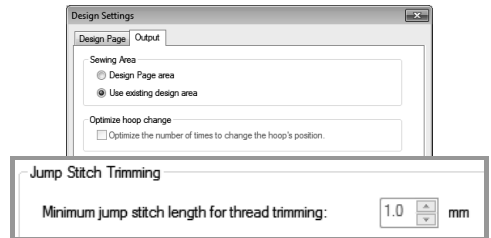

Specify the minimum jump stitch length for thread trimming.

Note:

These settings are not applied with any other embroidery machine. For details, refer to the Operation Manual provided with your machine.

Changing Application Settings

Changing the grid settings

A grid of dotted lines or solid lines can be displayed or hidden, and the spacing for the grid can be adjusted.

1. Click 1.

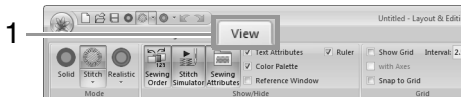

2. Specify the grid settings.

(3)

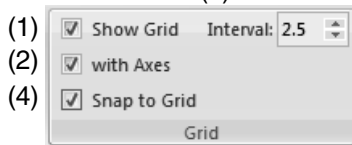

- (1) **Show Grid:**
Select this check box to display the grid.
- (2) **with Axes:**
Select this check box to display the grid as solid lines.
- (3) **Interval:**
Specify the grid spacing.
- (4) **Snap to Grid:**
Select this check box to align patterns with the grid.

Memo:

The snap feature works whether or not the grid is displayed.

Changing the ruler settings

The ruler can be displayed or hidden.

1. Click 1, then 2.

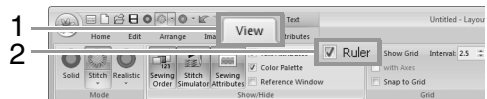

2. To display the ruler, select the Ruler check box.

To hide the ruler, clear the Ruler check box.

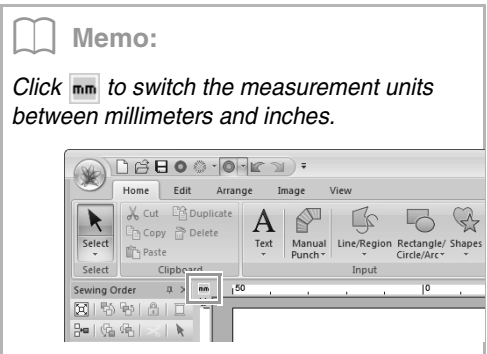

Creating Embroidery Patterns Containing Text

This section provides descriptions for entering text and the various operations for arranging them. In addition, details are provided for creating embroidery patterns whose text can easily be replaced.

From Layout & Editing, various embroidery patterns can be created for text.

The following types of text can be created.

- Built-in fonts:** This software is provided with 100 built-in fonts. (5 built-in fonts are specifically for small text)
- TrueType fonts:** TrueType fonts installed on your computer can be used to create embroidery patterns.
- Small fonts:** These small fonts have sizes between 3 and 6 mm (0.12 and 0.24 inch). Because of their size, these fonts are useful for beautifully sewing small text.
- Monograms:** Design custom monograms by combining text and decorative patterns.
- Custom fonts:** User-defined fonts can be created by using the Font Creator.

In addition, text can be arranged in the following ways.

- Text arrangement:** The text can be arranged along an outline or an arc.
- Transforming:** Text can be transformed into any of the 26 Transform styles.

Tutorial 3: Entering text

This section describes the procedures for entering text and arranging it in the Transform style with a fan shape.

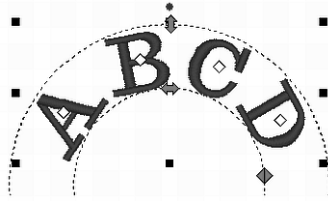

The sample file for this tutorial can be found at the following location.

Documents (My Documents)\PE-DESIGN NEXT\Tutorial\Tutorial_3

Step 1	Entering Text
Step 2	Transforming text

Step 1 Entering Text

- 1 Click 1, then 2, then 3.

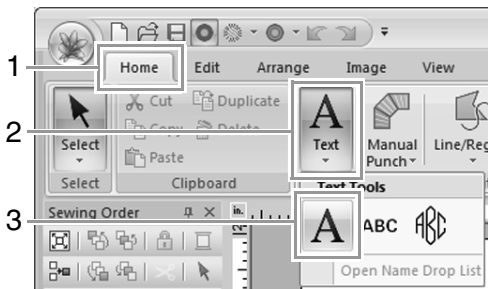

- 2 Click in the Design page.

→ A vertical dashed line will appear on the Design Page for typing directly on-screen.



- 3 From the keyboard, type in "ABCD".



The entered text appears.



Memo:

*Text can also be entered by clicking characters in the character table (1) in the **Text Attributes** tab.*

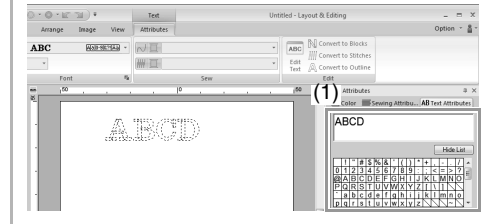

- Press the **Enter** key. The text appears in the Design Page.

ABCD



Memo:

The character font, size, color and sew type can be changed.



"Setting text attributes" on page 93 and "Embroidery attributes for text" on page 100

Step 2 Transforming text

- Click the text to select it.

ABCD

- Select the **Transform** check box (1), and then click 2.

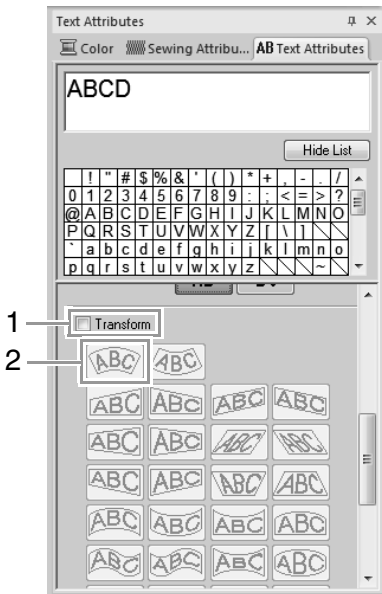

- Drag , and to transform the text.

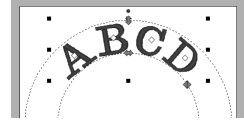

: Adjusts the text size.

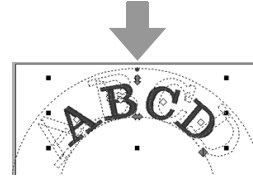

: Moves the text along the circle.

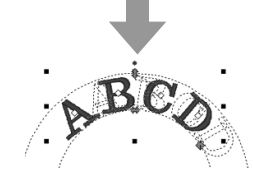

: Adjusts the radius of the circle.

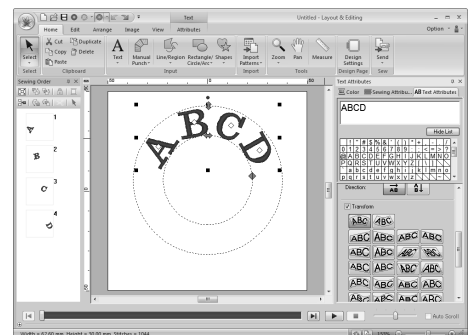
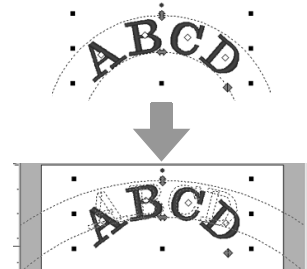

Advanced Operations for Entering Text

Entering text

1. Select the Text tool by clicking **1**, then **2**, then **3**.

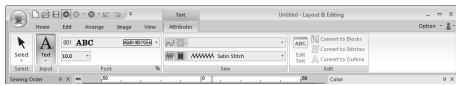
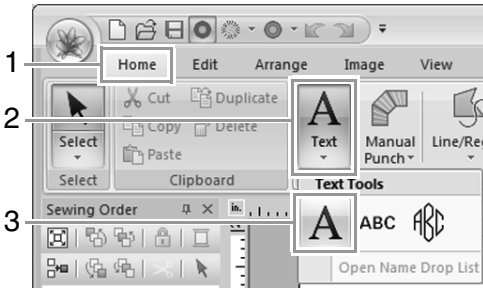

2. If necessary, change the font, text size, color and sew type.

👉 “Setting text attributes” on page 93 and “Embroidery attributes for text” on page 100

3. Click in the Design Page.

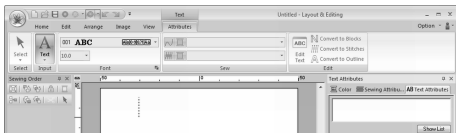

4. Type the text.

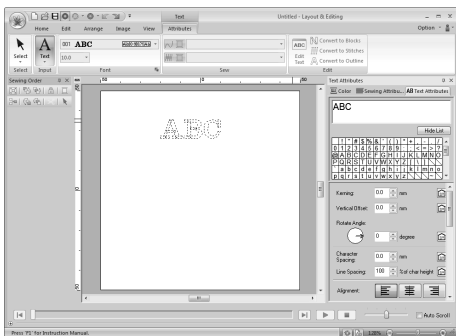

5. Press the **Enter** key or click the Design Page.

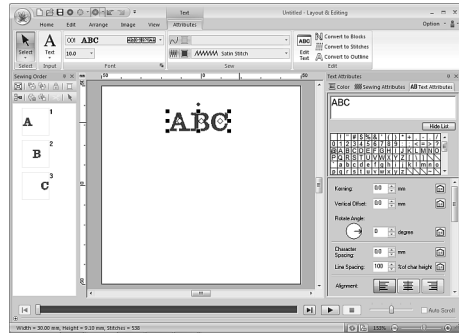

Memo:

- Hold down the **Ctrl** key and press the **Enter** key to enter a new line of text.
- Characters can also be entered by clicking them in the character table. This is particularly useful if you have to enter accented characters that are not available on your keyboard.
- Click **Hide List** to hide the character table. While it is hidden, click **Show List** to display the character table.

Note:

- Line sewing cannot be switched on with custom fonts and built-in fonts 025 and 029.
- If the entered character is not available with the selected font or if the character cannot be converted to an embroidery pattern, the character appears as  in the Design Page. If this occurs, enter a different character.

Editing entered text

1. Select a single text pattern.
2. Click 1, then 2.



Otherwise, click the **Text Attributes** tab (3), and then click in the text field (4).

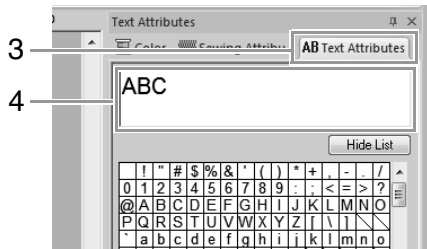

3. Edit the text as needed.

Press the **Enter** key or click the Design Page.

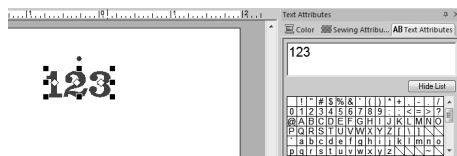

Setting text attributes

Text attributes can be specified with the **Font** selector and **Text Size** selector in the **Attribute** tab.





Memo:

The **Attributes** tab (under **Text**) appears when a text pattern or a Text tool is selected.

Font

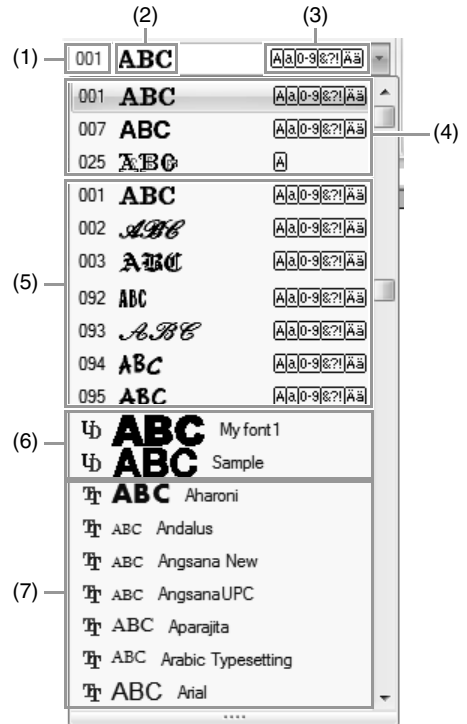
Click in the **Font** selector, and then click the desired font.



- (1) Font number
- (2) Font sample
If a single string of text is selected, the fonts in the list appear with the selected characters.
- (3) Types of characters available
 *Memo of "Font List" on page 313*
- (4) Most recently used fonts
- (5) Built-in Fonts
- (6) Custom Fonts
- (7) TrueType Fonts

- Custom Fonts

PEF files created with Font Creator and saved in the **MyFont** folder where PE-DESIGN was installed appear as userdefined fonts after the fonts listed in the table above.



The UD icon appears on custom fonts.

 *"Font Creator" on page 245*

- **TrueType Font**
The names and samples of installed TrueType fonts appear after the Custom Fonts.



Memo:

TrueType font settings can be changed in the **TrueType Font Attribute Setting** dialog box.



"Specifying TrueType font attributes" on page 95



Note:

- Text created using certain TrueType fonts may not be converted correctly into an embroidery pattern due to the shape of the character. These characters cannot be embroidered correctly. Test sew before embroidering on your project.
- In addition, text created using some TrueType fonts cannot be converted at all.

■ Text size

Click in the Text Size selector. Type the desired height and press the **Enter** key, or click the desired value.

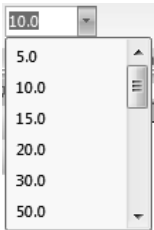

■ Specifying various text attributes

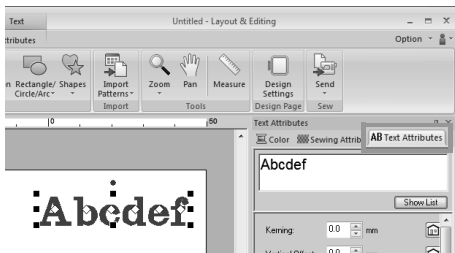

1. Select the text.
2. Click **Text Attribute** tab.



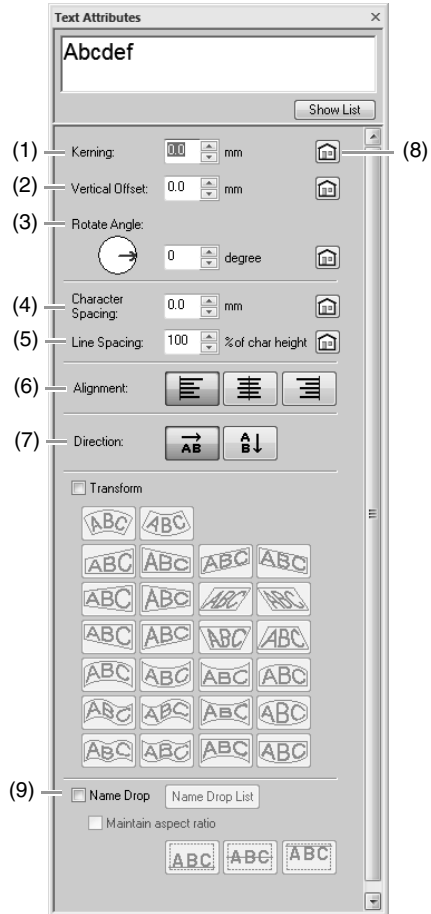

If the **Text Attributes** tab is not displayed, click the **View** tab in the Ribbon, and then click **Text Attributes**.

3. Change the text attributes.



(1) Kerning	0.0 mm A b c d e f	5.0 mm (between "A" and "b") A b c d e f	
(2) Vertical Offset	0.0 mm A b c d e f	2.0 mm A b c d e f	
(3) Rotate Angle	0° A b c d e f	20° A b c d e f	
(4) Character Spacing	0.0 mm A b c d e f	2.0 mm A b c d e f	
(5) Line Spacing	100% A b c d e f g h i j k l	150% A b c d e f g h i j k l	
(6) Alignment	Left A b c d e f g h i j k l	Center A b c d e f g h i j k l	Right A b c d e f g h i j k l
(7) Direction	Horizontal A B C	Vertical A B C	
(8)	Click to return to the default setting. 		
(9) Name Drop	 "Name Drop Feature (Replacing Text)" on page 111.		

 **Memo:**

- Both **Kerning** and **Character Spacing** set the spacing between characters. **Character Spacing** is always applied to the entire text pattern, while **Kerning** can be applied to individual characters.
-  Refer to "Selecting characters" on page 97 for more details about selecting individual characters in a text pattern.
- Settings (1) (2) (3) specified in the **Text Attributes** tab are applied to all selected characters.

■ Specifying TrueType font attributes

1. Select text in a TrueType font.
2. Click 1, then 2.

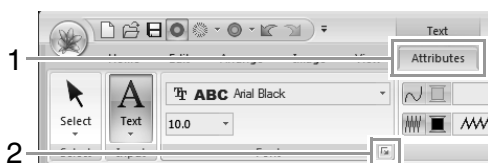

3. Select a font style from the **Font style** selector, select a character set from the **Script** selector, and then click **OK**.

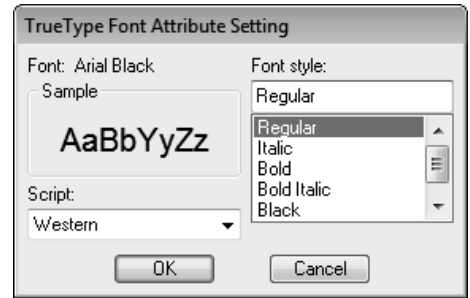

 **Note:**



- The settings for **Font style** and **Script** differ depending on the TrueType font that is selected.
- If text created from multiple TrueType fonts is selected, this command is not available. In addition, if text of the same font but different font styles or scripts is selected, this dialog box appears with the attribute settings for the first letter in the text. In either case mentioned above, selecting only one character from within text displays a dialog box containing only that character's attributes.

■ Transforming text

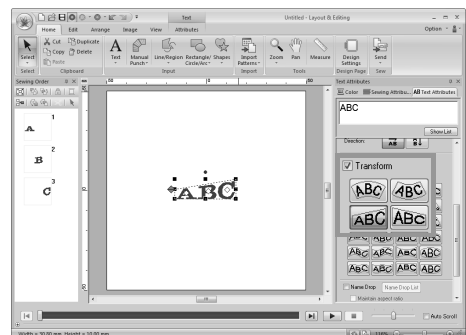

1. Select the text.
2. Select the **Transform** check box, and then click the transformation shape button.



Depending on the selected shape, a dotted line  and  or appear around the text.



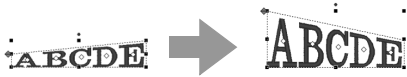

Note:
 A text pattern contains data for both line and region sewing. Therefore, if this command is selected, depending on the form of the font, there may be a gap between the line and the region in the text.

3. Drag  to transform the text.



Memo:

-  can only be dragged vertically.
-  can only be dragged horizontally.

To return the transformed text to its original shape, clear the **Transform** check box.



Fitting text to an outline

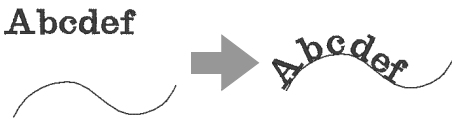

1. Select the text or small text and an outline.



2. Click 1, then 2, then 3.

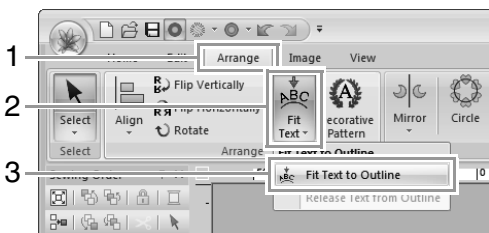

3. Specify the desired settings in the **Fit Text to Outline Attribute Setting** dialog box, and then click **OK**.

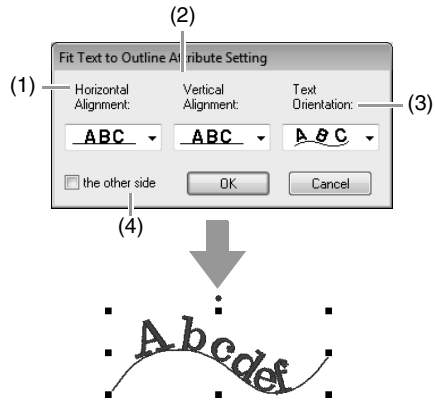

(1) Horizontal Alignment		
(2) Vertical Alignment		
(3) Text Orientation		
(4) the other side	<input type="checkbox"/> the other side <input checked="" type="checkbox"/> the other side	

Note:

- When fit text to outline is specified, the text transformation is cancelled.
- Only one string of text can be arranged on a single outline.

Memo:

- To change the position of text on the outline, select the text, and then drag it.
- The settings for some text attributes (**Size**, **Character Spacing**, **Vertical Offset** and **Rotate Angle**) can be changed for single characters, even with text fit to an outline.

 "Selecting characters" on page 97

■ Releasing text from an outline

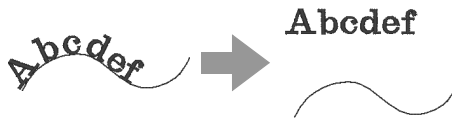

1. Select text or small text that is arranged on an outline.
2. Click 1, then 2, then 3.

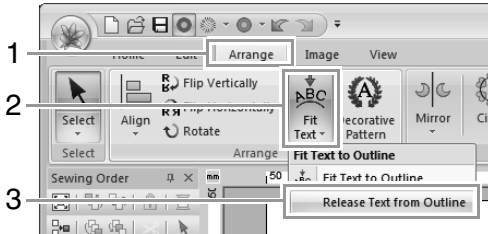

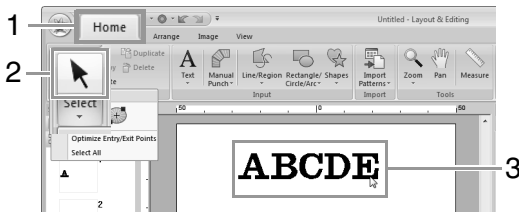

Selecting characters

1. Select the text.
Click 1, then 2, then 3.



Memo:



If  is not displayed at 2, click the arrow at the bottom of the button, and then click .

2. Select characters in the text.

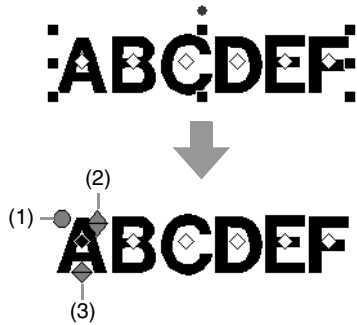

To select a single character, click  for the character.



- (1) Rotation handle
- (2) Size handle
- (3) Vertical offset handle

To select multiple characters, hold down the **Ctrl** key and click each  for the other characters, or drag the pointer over  of characters.

Memo:

Multiple  can be selected and the selected  can be changed in the same way that embroidery pattern points are selected.

 "Selecting points" on page 62

Easy changes to the character size and attributes

You can easily use drag operations to change the size and text attributes.

■ Changing the size

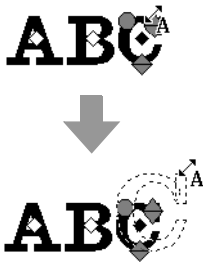

1. Bring the pointer onto the upper right  handle.
2. Drag the handle.



3. When you release the mouse button, the character size is changed.



■ Changing the kerning

1. Place the pointer onto the character body other than the    handles, and drag the character horizontally.

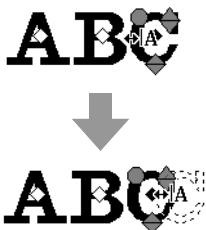

2. When you release the mouse button, the character spacing is changed.



■ Changing the vertical offset

1. Bring the pointer onto the lower  handle.
2. Drag the handle vertically.

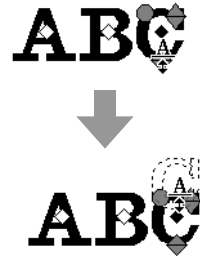

3. When you release the mouse button, the character offset is changed.



■ Rotating the characters

1. Bring the pointer onto the  handle.
2. Drag the handle.

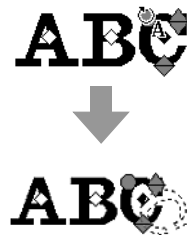

3. When you release the mouse button, the character angle is changed.



Converting text to blocks

Text can be converted into blocks (manual punching data), allowing you to adjust the shape of the characters.

1. Select the text or monogram text.
2. Click 1, then 2.

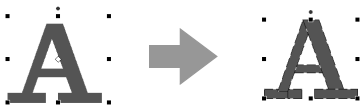

If line sewing was specified for the text, the line sewing is converted to an outline.

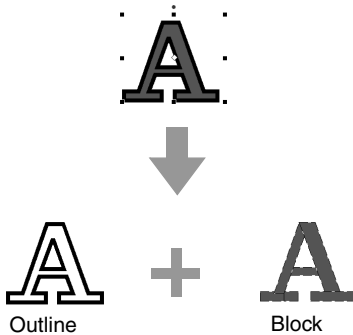

Note:
Small Text cannot be converted into blocks.

For details on editing blocks or outlines, refer to "Reshaping Embroidery Patterns" on page 62.

Converting text to outline pattern

Text pattern Outline pattern

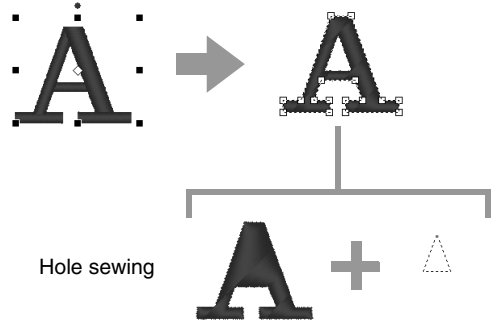

1. Select text.
2. Click 1, then 2.

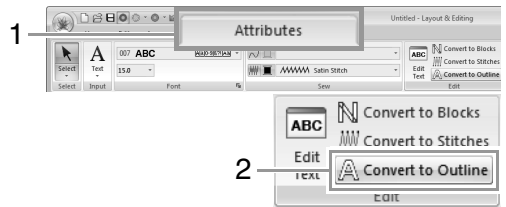

Memo:

Transformed shapes are grouped. In addition, hole sewing is automatically specified for openings (such as the triangle inside the letter "A").

Note:

Text patterns created with built-in fonts 025 and 029, custom fonts or Small Text fonts cannot be converted to outlines.

Selecting connection point positions in a text pattern

The positions for connection points between characters within the same text (end point of one character and the start point of the next character) can be specified.

The available settings are **Default**, **Closest** and **Farther**.

1. Select the text or monogram text.
If the **Sewing Attributes** tab is not displayed, click **View** tab in the Ribbon, then **Sewing Attributes**.
2. Click a setting under **Connection Points**.

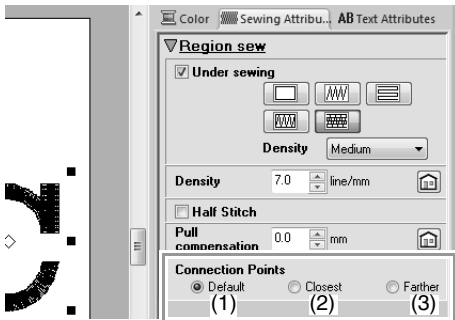

(1) **Default**



Stitches are created in the default sewing order for good stitching quality of all characters.

(2) **Closest**



Stitches are created at the shortest distance between the end point of one character and the start point of the next character. This shortens jump stitches and reduces the number of times that the thread is trimmed.

(3) **Farther**



Stitches are created at a farther distance between the end point of one character and the start point of the next character. This lengthens jump stitches so they can easily be trimmed manually.

A Connection Point setting can be selected not only for region sewing, but also for line sewing.

Note:











- These settings are not available with text created using built-in fonts 025 or 029, a TrueType font, a custom font or a Small Text font.
- These settings are not available for text containing characters of different colors.
- These settings are not available for text where the sewing order of the characters is not continuous.

Embroidery attributes for text

The Sew group in the Attributes tab allows you to set the embroidery attributes (thread color and sew type, outline and inside region on/off).

When text is selected, settings can be specified for the following.



 <p>Line sew</p>	<p>Switches on/off sewing for the line. When sewing for the outline is switched off, it is not sewn (and you cannot set its color or sew type).</p> <p> "Line sew / Region sew" on page 56</p>
 <p>Region sew</p>	<p>Switches on/off sewing for the region. When sewing for the inside region is switched off, it is not sewn (and you cannot set its color or sew type).</p> <p> "Line sew / Region sew" on page 56</p>
 <p>Line color Region color</p>	<p>Sets the thread color for outlines and inside regions.</p> <p> "Color" on page 56</p>
 <p>Line sew type</p>	<p>Sets the sew type for the outlines.</p> <p> "Sew type" on page 57</p>
 <p>Region sew type</p>	<p>Sets the sew type for an inside region.</p> <p> "Sew type" on page 57</p>

 **Memo:**

The variety of embroidering effects possible differs depending on the selected combination of settings for line sewing and region sewing.



Line sewing : On
Region sewing : On



Line sewing : Off
Region sewing : On



Line sewing : On
Region sewing : Off

 **Note:**

- Text patterns created using built-in fonts (except 025 and 029) or TrueType fonts have an outline and an inside region whose sewing can independently be turned on/off and assigned different thread colors and sew types.
- Text patterns created using built-in fonts 025 and 029 or custom fonts only have an inside region. The thread color and sew type for only the region can be selected.
- Sewing attribute that can be set with Text under sewing. For details, refer to p301.

Small text

■ Entering Small text

1. Select the Small Text tool by clicking **1**, then **2**, then **3**.

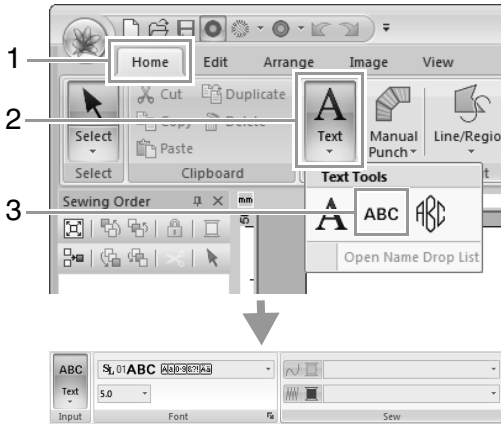

2. Enter text in the same way that regular text is entered, starting with step 2.

"Entering text" on page 92

Note:

Precautions for embroidering Small Text patterns

- Reduce the thread tension to less than what is used when embroidering normal designs.
- Sew at a speed slower than what is used when embroidering normal designs. (For details on adjusting the thread tension and sewing speed, refer to the Operation Manual provided with your embroidery machine.)
- For best results when sewing small font patterns, do not cut the jump stitches between the characters. (For details on setting the machine for thread cutting, refer to the Operation Manual for the embroidery machine.)

■ Editing Small text

Small Text attributes can be selected from the **Attributes** tab in the Ribbon, the **Text Attributes** pane and the **Color** pane. When the Small Text tool is selected, the **Attributes** tab appears as shown below.



Memo:

The **Attributes** tab (under **Text**) appears when a small text pattern or the Small Text tool is selected.

Small text font

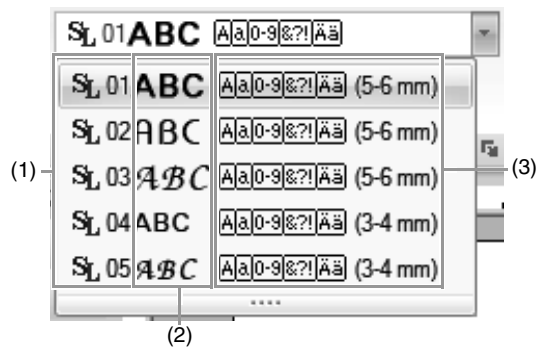

(1) Font number

(2) Font sample

(3) Types of characters available

Memo of "Font List" on page 313

Note:

Only built-in fonts specifically for small text can be used.

For a list of the built-in fonts specifically for small text, refer to "Small text" on page 313.

The settings for all Small Text attributes except the font are specified in the same way that they are specified for regular text patterns.

However, with Small Text, settings cannot be specified for the following.

- Sew type
- Sewing Attribute
- Transform
- Name Drop

Tutorial 4: Monograms



The sample file for this tutorial can be found at the following location.
Documents (My Documents)\PE-DESIGN NEXT\Tutorial\Tutorial_4

Step 1	Entering monograms
Step 2	Adding a decorative pattern
Step 3	Changing the font and character size of the monogram
Step 4	Changing the thread color and sew type of the monogram

Step 1 Entering monograms

- 1 Click 1, then 2, then 3.



→ The **Attribute** tab appears in the Ribbon.

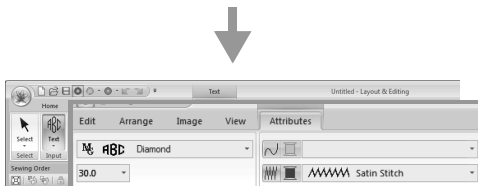

The font, character size and sew type can be specified from the **Attribute** tab.

- 2 Click in the Design Page.

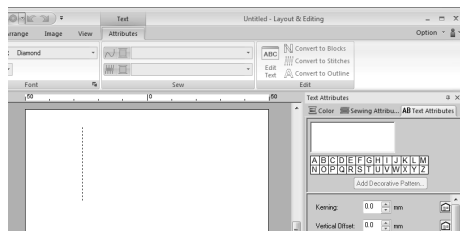

- 3 From the keyboard, type in "ABC".

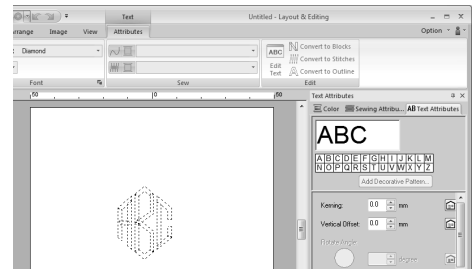

- 4 Press the **Enter** key.

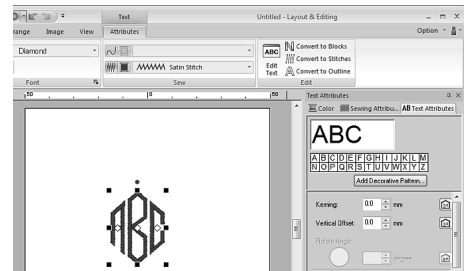

Memo:

- Characters can also be entered from the character table (1) in the **Text Attributes** tab.

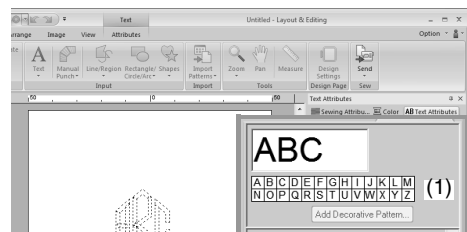

- You cannot insert line feeds.
- A maximum of three characters can be entered.
- Only uppercase letters (the characters displayed at (1)) can be entered.

Step 2 Adding a decorative pattern

To add a decorative pattern, select the monogram, and then click **Add Decorative Pattern** (1).

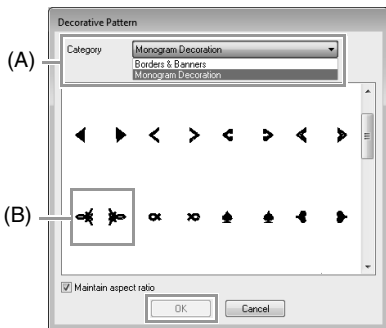
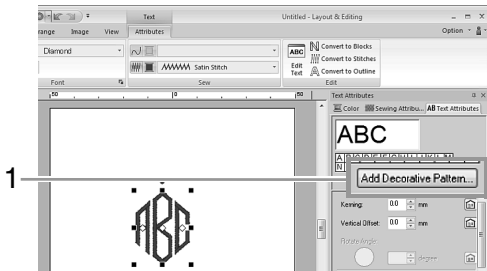

In the **Category** list (A), select **Monogram Decoration**, select the desired decorative pattern (B), and then click **OK**.

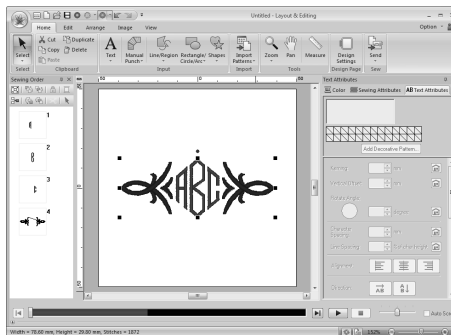

→ The decorative pattern is added.

Step 3 Changing the font and character size of the monogram

Changing the font of the monogram

Click 1, then 2, then 3, then 4.

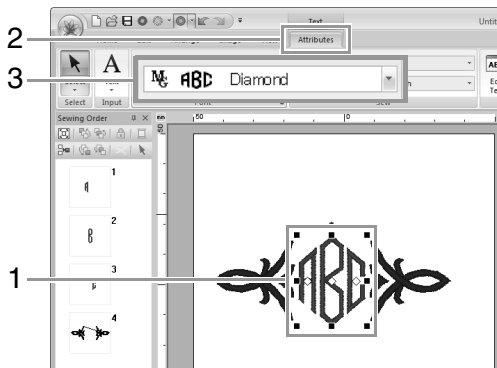

Monogram font sample Monogram font name



■ Changing the character size of the monogram

Click 1, then type in "22"

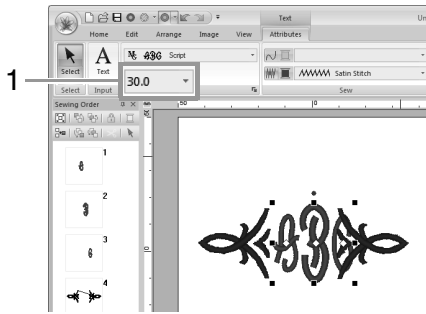

Memo:

Diamond and Script are fonts exclusively for monograms. You can also use the built-in fonts or TrueType fonts.

"Editing monograms" on page 106

Step 4 Changing the thread color and sew type of the monogram

Click the point for the monogram character whose settings are to be changed.

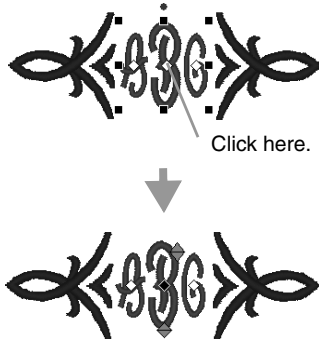

■ Changing the thread color

Click 1, then 2.

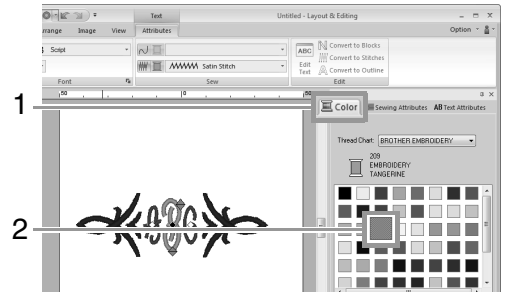

■ Changing sew type

Click 1, then 2, then 3.

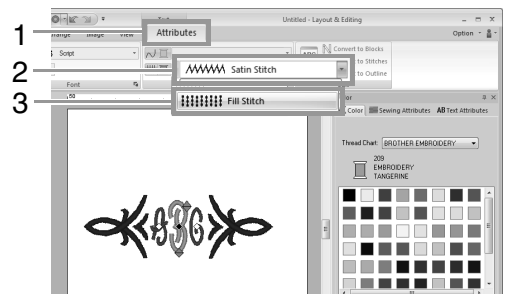

Advanced Operations for Entering Monograms

Editing monograms

Monogram attributes can be selected from the **Attributes** tab in the Ribbon, the **Sewing Attributes** pane, the **Text Attributes** pane and the **Color** pane. When the Monogram tool is selected, the **Attributes** tab appears as shown below.



Memo:

The **Attributes** tab (under **Text**) appears when a monogram or the Monogram tool is selected.

■ Monogram font

Click in the **Font** selector, and then click the desired font.

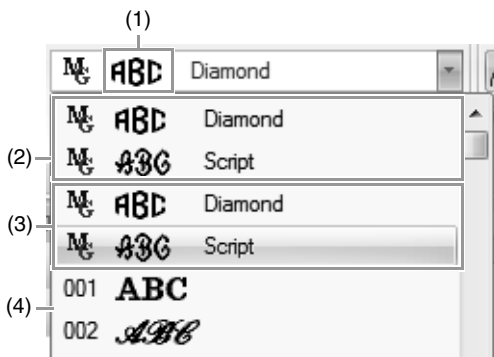

- (1) Font sample
If a single monogram is selected, the fonts in the list appear with the selected monogram characters.
- (2) Most recently used fonts
- (3) Monogram fonts
- (4) Other fonts



Memo:

Diamond and Script are fonts exclusively for monograms. You can also use built-in fonts, custom fonts and TrueType fonts.



For a list of the built-in fonts and monogram fonts, refer to "Font List" on page 310.

The settings for all monogram attributes except the font are specified in the same way that they are specified for regular text patterns.

However, with monograms, settings cannot be specified for the following.

- Rotate Angle, Character Spacing, Line Spacing, Alignment, Direction
- Transform
- Name Drop
- Fit text to outline

Tutorial 5-1: Using Name Drop

With the Name Drop feature, you can easily create a number of similar embroidery patterns, for example, for uniforms, by replacing only the name in the pattern.



In this section, we will see how easy it is to use the Name Drop feature by practicing with a sample file where the Name Drop function has already been applied. Let's start by opening the file **tutorial_5-1.pes** in the folder **Documents (My Documents)\PE-DESIGN NEXT\Tutorial\Tutorial_5**.

"Opening a Layout & Editing file" on page 77.

Step 1	Practicing replacing text
Step 2	Creating the list
Step 3	Outputting patterns using text from the text list

Step 1 Practicing replacing text

Text can be replaced by simply clicking the desired text in the list.

- 1 Click Name Drop List button (1).



If the **Text Attributes** tab is not displayed, click the **View** tab in the Ribbon, and then click **Text Attributes**.

- 2 Click text other than the currently selected text (row 2).



→ A preview of the pattern appears with the selected text.

Step 2 Creating the list

- Now, we will add text at the end of the list. Click the cell in the **+** row.

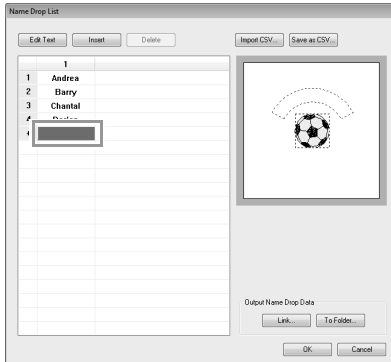

- Use the keyboard to enter the text, and then press the **Enter** key.

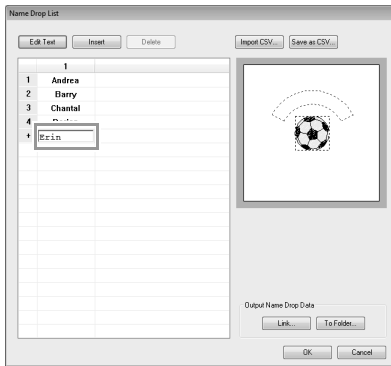

Step 3 Outputting patterns using text from the text list

Let's practice outputting the patterns to files. Embroidery data with the text replaced by each row of text in the list can be outputted.

- Click **to Folder**.

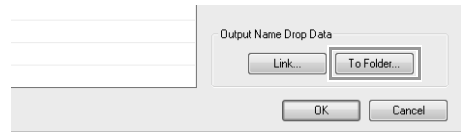

- Select the drive and folder (1), type the name of the file in the **File name** box (2), and then click **OK** (3).

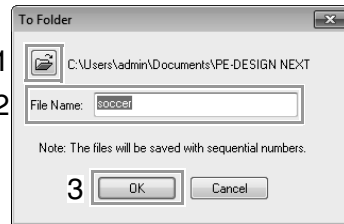

→ This application begins checking that there are no errors in the embroidery data. If no errors were detected, it begins outputting the data.

Memo:

The files are named “<file_name>xxx.pes” (where “xxx” are consecutive numbers starting with 001).

- After the data has been outputted, the following message appears. Click **OK**.

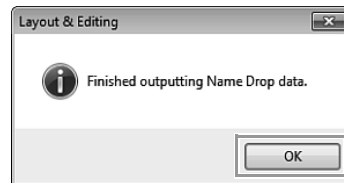

An embroidery file is saved in the selected folder for each line of text in the list.

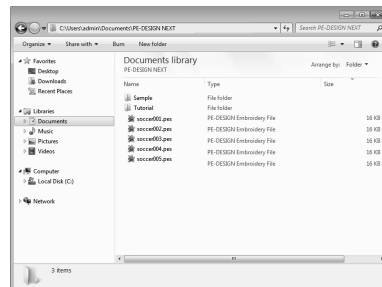

Tutorial 5-2: Creating Name Drop

Next, let's create the following pattern and apply this attribute.



The sample file for this tutorial can be found at the following location.
Documents (My Documents)\PE-DESIGN NEXT\Tutorial\Tutorial_5

Step 1	Designing the embroidery pattern
Step 2	Creating the list
Step 3	Outputting patterns using text from the text list

Step 1 Designing the embroidery pattern

- 1 Click 1, then 2, then 3.

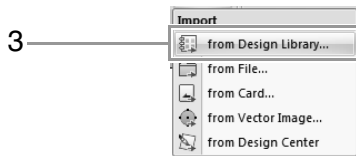
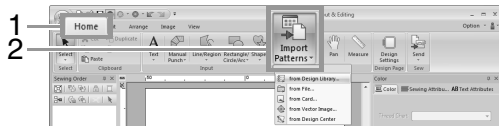

- 2 Select **Misc** from the **Category** selector, and then drag the rainbow pattern into the Design Page.

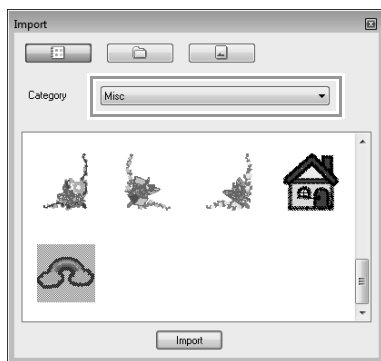

- 3 Click 1, then 2, then 3, and then click the Design Page.

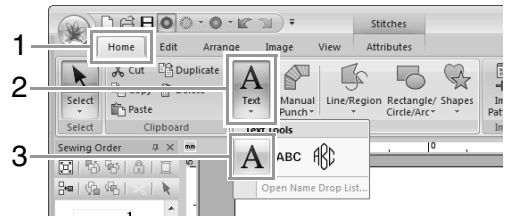

- 4 Type in "Fernand", and then press the **Enter** key.



- 5 Select the text pattern (1), select the **Transform** check box (2), and then click 3.

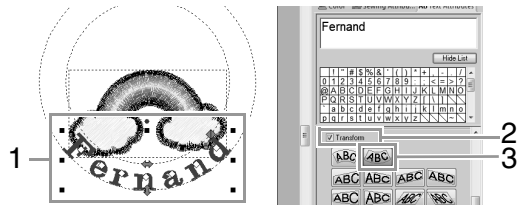

- 6 Drag the pattern to adjust its position.

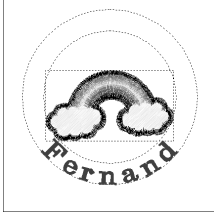

Step 2 Creating the list

- 1 Select “Fernand”, and then select the **Name Drop** check box (1), and click **Name Drop List** button (2).

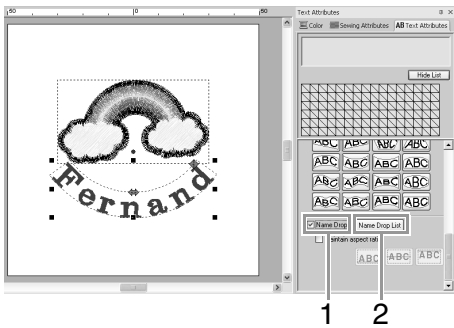

- 2 Enter text in the list.
 (1) Select a cell, and then click **Edit Text** to enter input mode.

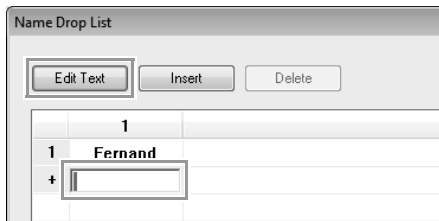

- (2) Use the keyboard to enter the text.

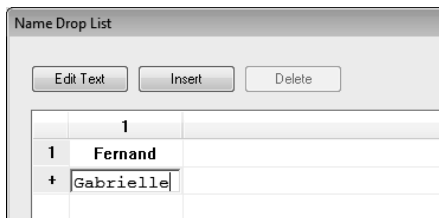

- (3) When entering text, press the **Enter** key so that the cell in the next row enters input mode.

Repeat steps (1) through (3) to create the text list.

Step 3 Outputting patterns using text from the text list

Refer to Step 3, “Outputting patterns using text from the text list”, on page 108.

Name Drop Feature (Replacing Text)

Text attributes with the Name Drop attribute applied

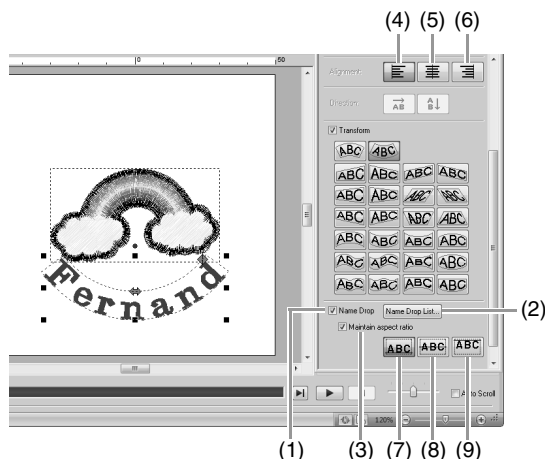

- (1) **Name Drop**
If this check box is selected, the **Name Drop** attribute is applied.

Note:

• When the **Name Drop** attribute is applied, the settings for **Kerning**, **Vertical Offset**, **Rotate Angle**, **Character Spacing**, **Line Spacing**, the character size and color will be reset.



• The **Name Drop** attribute is not available with text where the **Fit Text to Outline** command has been specified, **Small Text** or **monogram** text.

- (2) **Name Drop List**
Click this button to display the **Name Drop List** dialog box.
- (3) **Maintain aspect ratio**
If this check box is selected, the height-to-width ratio of the text is maintained.

Alignment

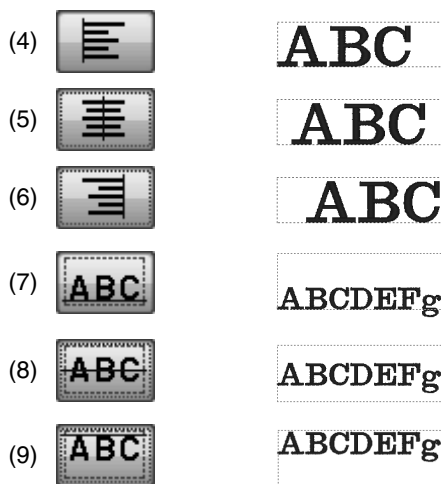

Functions in the Name Drop List dialog box

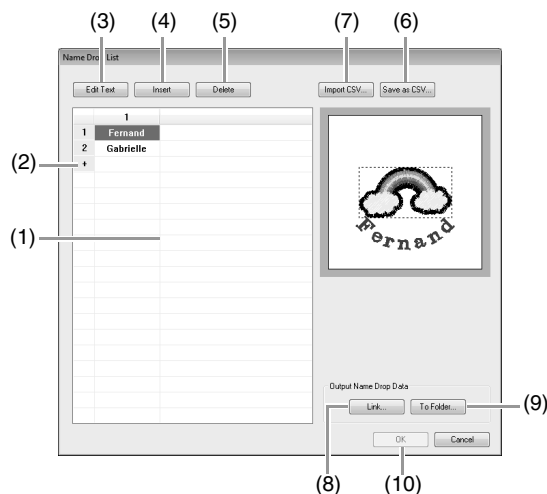

- (1) **Name Drop List:** Create the list of text to be used to replace text in the pattern. Double-click a cell to enter input mode. Select a row to display a preview of the pattern with the text in that row. A row in the text list can be selected by pressing the or key.
- (2) Click to add a row at the end of the list. (Up to 500 rows can be added.)

- (3) Edit Text
Enters input mode for the text in the selected cell. (Input mode can also be entered by double-clicking a cell.)
- (4) Select a row, and then click **Insert**. A new row is inserted above the selected one.
- (5) Select a row, and then click **Delete**. The selected row is deleted.

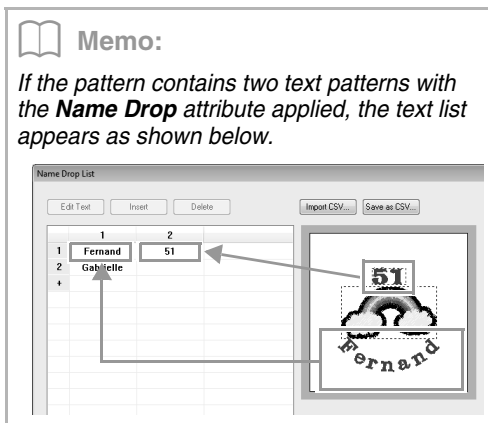

■ Saving / importing a text list (CSV)

- (6) Saves the created Name Drop List. Click this button, select the drive and folder, type the name of the file in the **File name** box, and then click **Save** to save the list as a .csv file.
- (7) Imports a Name Drop List as a .csv file. Click this button, select the drive and folder, click the name of the file, and then click **Open**, or double-click the file's icon.

■ Outputting patterns using text from the text list

- (8) Click to send to machines by using the Link function. This button is available if an embroidery machine compatible with the Link function is connected to the computer. Connect a compatible embroidery machine that has been started in Link mode.

 *"Using the Link Function to Embroider From the Computer" on page 177*

- (9) To Folder

 *"Outputting patterns using text from the text list" on page 108*

■ Editing a pattern with text replaced

- (10) Select text in the **Name Drop List** dialog box and click **OK** to return to the Design Page and edit the pattern with the text replaced.

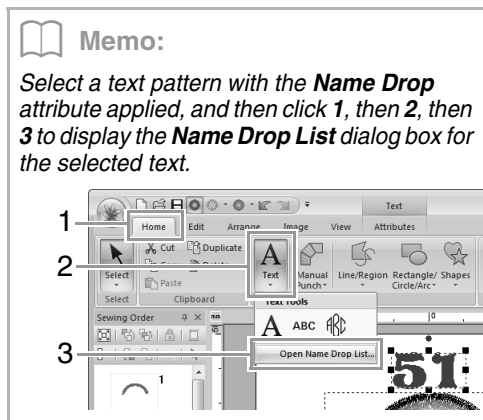

Tutorial 5-3: Using Templates

Using the Template wizard, you can easily create custom embroidery patterns by simply changing the text in the patterns that are already available. Follow each step to create a custom embroidery pattern.

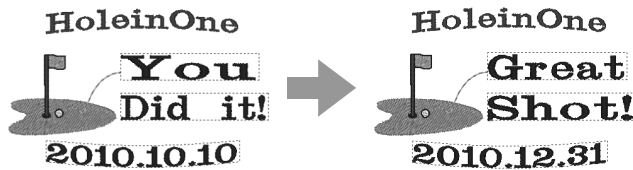

Step 1	Starting the Template wizard
Step 2	Selecting the type of template to be used
Step 3	Editing the text
Step 4	Outputting the edited template

Step 1 Starting the Template wizard

When Layout & Editing starts up, the first dialog box of the wizard appears.

- 1 Click 1.

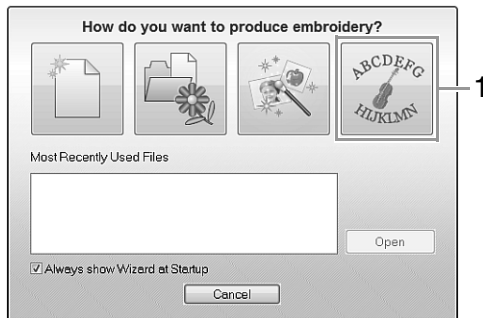

Memo:

This wizard can also be opened by clicking 1, then 2.

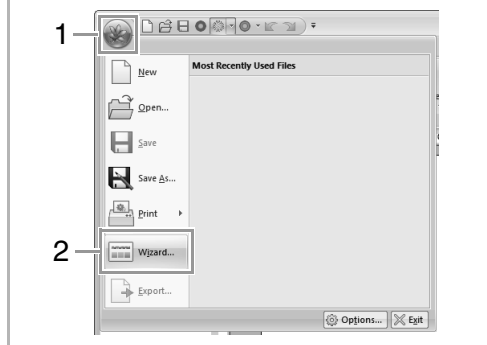

Step 2 Selecting the type of template to be used

- 1 Click the template to be used (1), and then click **Next** (2).

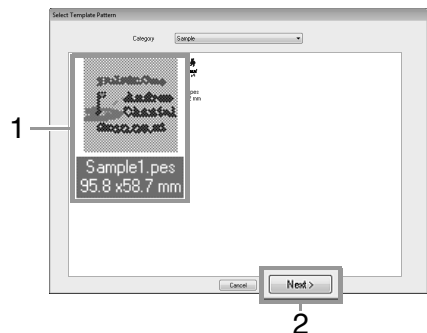

Memo:

To select a different variety of templates, select a category from the **Category** selector.

Step 3 Editing the text

- 1 Click the row containing the text to be changed (1), and then click **Edit Text** (2).

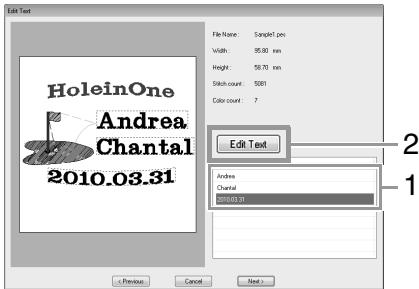

- 2 Type in the text at (3), press the **Enter** key.



- 3 Click **Next**.

Step 4 Outputting the edited template

Select the output destination.

- 1 At 1, select an output destination for the embroidery machine to be used, and then click **Send** (2).

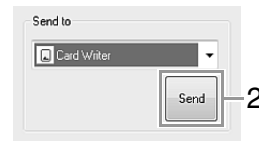

Note:

Select an output destination according to the method used to transfer data to your embroidery machine.



"Transferring Embroidery Designs to Machines" on page 174.

- 2 To create an embroidery pattern using a different template, click **Create New Embroidery Design**.
→ The dialog box from Step 2 appears again.
To close the wizard, click **Cancel**.

Template Feature

About the Edit Text dialog box

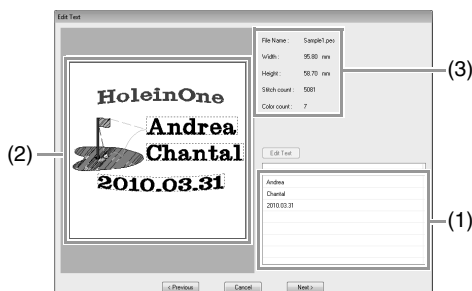

- (1) Lists text that can be edited. Edit the text here.
- (2) Check the results of the edited text.
- (3) Shows the embroidery information for the template.

■ Editing the text

1. Select the text in (1), and then click **Edit Text**.
→ The text is highlighted.
2. Use the keyboard to input the text.
3. Repeat steps 1 and 2 for each text.
→ The results of editing appear in (2).

About the Output dialog box



- (1) Opens the template in a Design Page, where it can be edited or saved.
- (2) Specifies the output destination.
- (3) Outputs the template.
- (4) Returns to the dialog box for selecting a template. A different template can be edited.

■ Outputting the edited template

Send to USB Memory, Send to Your Machine, Write to Card and Link are available as output destinations. Select an output destination according to the method used to transfer data to your embroidery machine.

1. Depending on the desired output destination, prepare the original card or USB media. Otherwise, connect the embroidery machine to the computer.
2. Select the output destination at (1), and then click **Send** (2).

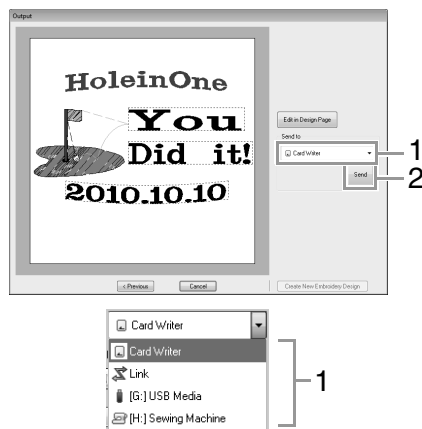

Note:

Select an output destination according to the method used to transfer data to your embroidery machine.

👉 “Transferring Embroidery Designs to Machines” on page 174 and “Using the Link Function to Embroider From the Computer” on page 177

Saving a new template

A design that you have created can be used as a template.

- 1 Design an embroidery pattern that contains text with the **Name Drop** attribute applied.
→ The text with the **Name Drop** attribute applied is the part of the pattern that can be changed.

 *"Name Drop Feature (Replacing Text)" on page 111*

- 2 Save the created embroidery pattern in a folder of the **Template Library** folder. Click **1**, then **2**.



- 3 Select the folder (Drive where PE-DESIGN was installed)**Program Files (Program Files (x86))\Brother\PE-DESIGN NEXT\Template Library\Sample**, type in the file name, and then click **Save**.

Creating Embroidery Patterns Using Images

Embroidery patterns can easily be created from images. In addition, this section provides details on creating an embroidery pattern that is combined with an image.

Stitch Wizard: Automatically Converting an Image to an Embroidery Design

An embroidery pattern can be created from a digital camera photo, a scanned illustration, or a clip art image.

■ Auto Punch (👉 p. 119)

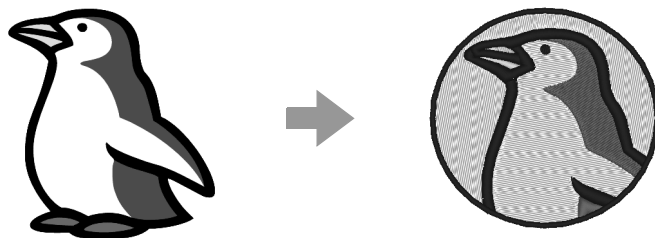

■ Photo Stitch 1 (👉 p. 122)

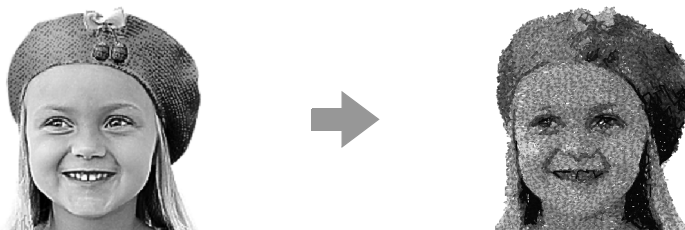

■ Photo Stitch 2 (👉 p. 127)

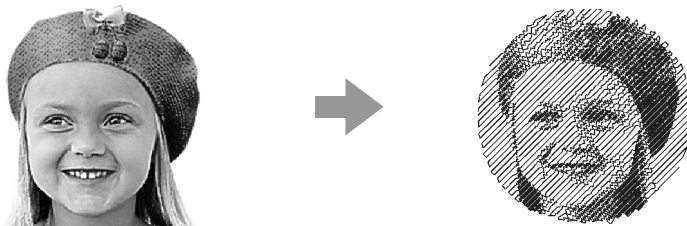

■ Cross Stitch (👉 p. 130)

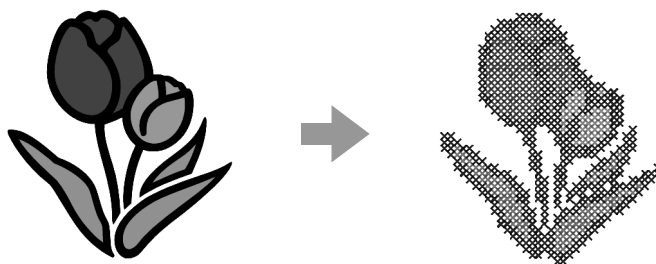

Tutorial 6-1: Auto Punch

In this section, we are going to use the Auto Punch function to automatically create an embroidery pattern from an image.

Step 1	Importing image data into Layout & Editing
Step 2	Starting the Auto Punch wizard
Step 3	Applying an image mask and adjusting its size and position
Step 4	Creating a border from the mask outline and converting to an embroidery pattern

Step 1 Importing image data into Layout & Editing

- 1 Click 1, then 2, then 3.

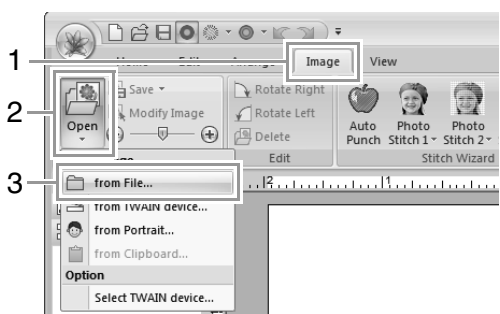

- 2 Double-click the **Documents (My Documents)\PE-DESIGN NEXT\Tutorial\Tutorial_6** folder to open it.

Memo:

When this application is installed, the **PE-DESIGN NEXT** folder is installed in the **Documents (My Documents)** folder.

- 3 Select the file **penguin.bmp**, and then click **Open**, or double-click the file's icon.

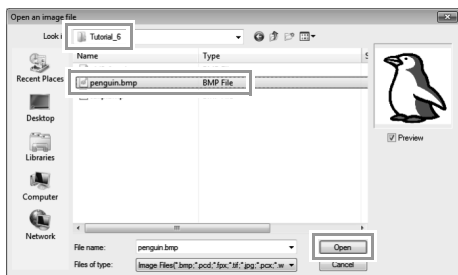

→ The image appears in the work area.

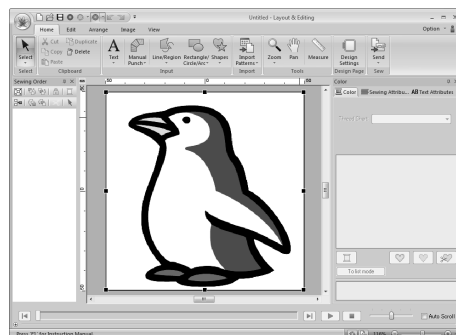

Memo:

- Images with few and distinct colors work best with Auto Punch.
- Repeat steps 1 to 3 to choose another picture image.
- You can import picture images from a scanner, or clipboard, or even create images with the portrait function and import that image.

☞ "Importing Image Data" on page 137

Step 2 Starting the Auto Punch wizard

- Click 1, then 2.

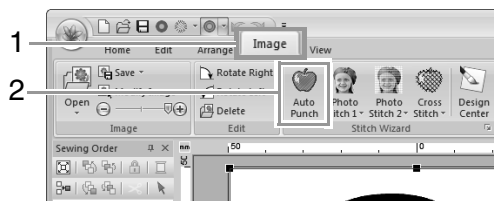

Step 3 Applying an image mask and adjusting its size and position

- 1 Click **1** to select the circle mask. Drag handle **2** to adjust the size of the mask, and drag the mask to adjust its position. Click **Next**.

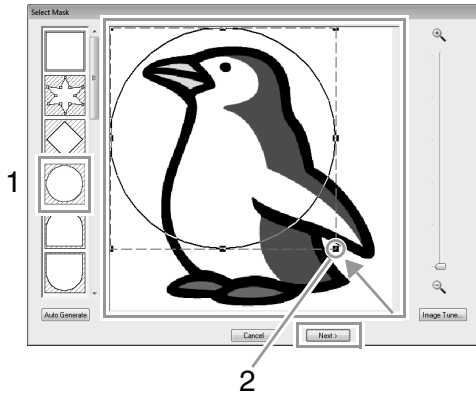

Memo:

The mask outline selected here can be used as line data (border) in Step 4.

"Select Mask dialog box" on page 134.

- 2 **1** indicates the Design Page. Drag the image to adjust its output location and size. Click **Next**.

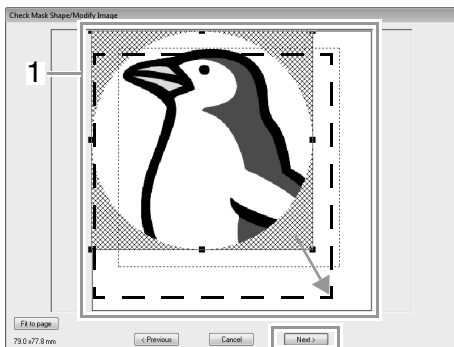

"Check Mask Shape/Modify Image dialog box" on page 135

Step 4 Creating a border from the mask outline and converting to an embroidery pattern

Select the **Add mask outline** check box, check the preview image, and then click **Finish**.

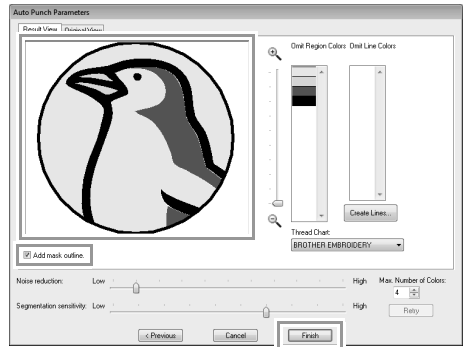

→ The image is automatically hidden and stitches are automatically input.

Auto Punch Features

Auto Punch Parameters dialog box

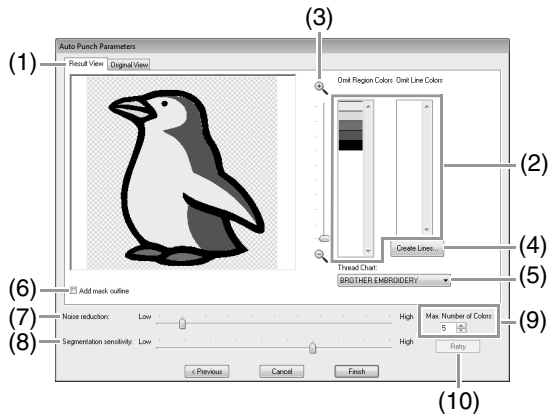

(1) Result View

The resulting analyzed image appears in the image preview box on the **Result View** tab.

To display the original image, click the **Original View** tab.

(2) Omit Region Colors/Omit Line Colors

In the **Omit Region Colors** list and **Omit Line Colors** list, click the colors to select whether or not they will be sewn.

You can select whether or not areas will be sewn by selecting their colors. Colors that are crossed out are set to not be sewn.

Memo:

- To select whether or not a part of the image is to be sewn, click in the preview box on the **Result View** tab, or click in the **Omit Region Colors** and **Omit Line Colors** lists.
- Areas filled with a crosshatch pattern on the **Result View** tab will not be sewn. In addition, lines that appear as dotted lines will not be sewn.

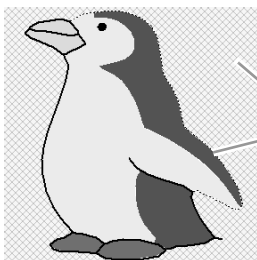

These areas will not be sewn.

(3) Zoom

(4) Create Lines

Click this button to display the **Select Regions** dialog box, where the areas to be converted to lines can be selected.

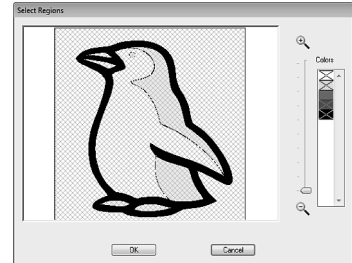

Click the areas to be converted to lines, and then click **OK**.

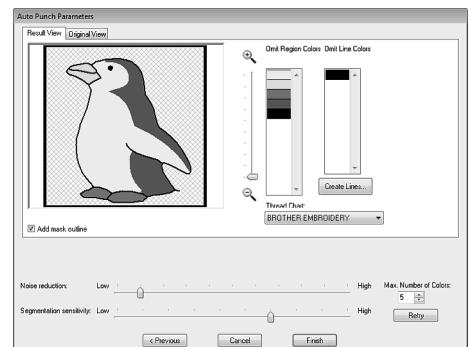

(5) Thread Chart

Select the thread chart to be used.

(6) Add mask outline

If this check box is selected, line data is created from the mask outline.

(7) Noise reduction

Sets the level of noise (distortions) that is removed from the imported image.

(8) Segmentation sensitivity

Sets the sensitivity for the image analysis.

(9) Max. Number of Colors

Sets the number of colors used.

(10) Retry

To view the results of the changes, click this button.

Tutorial 6-2: Photo Stitch 1

By using the Photo Stitch 1, embroidery patterns can be created from photos.

Step 1	Importing photo data into Layout & Editing
Step 2	Starting the Photo Stitch 1 wizard
Step 3	Masking by removing the background
Step 4	Automatically correcting the image and creating an embroidery pattern

Step 1 Importing photo data into Layout & Editing

Select the **Tutorial_6** folder, and then select **girl2-face.bmp** as the image.

 "Importing image data into Layout & Editing" on page 119

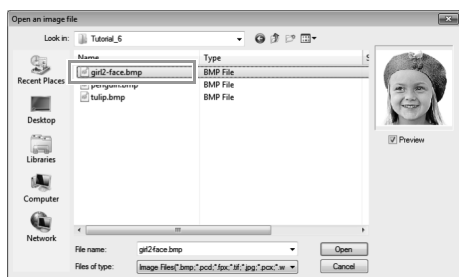

Step 2 Starting the Photo Stitch 1 wizard

Click **1**, then **2**, then **3**.

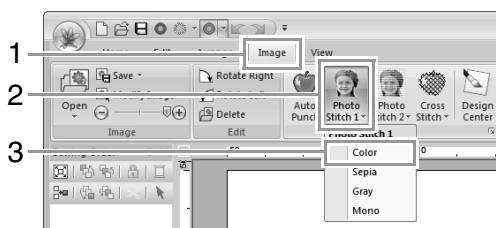

Memo:

With Photo Stitch 1, an embroidery pattern can be created in color (**Color**), sepia (**Sepia**), grayscale (**Gray**) or one color (**Mono**). For this example, select **Color**.

Step 3 Masking by removing the background

1 Click **Auto Generate**, then **Next**.



Memo:

- The **Auto Generate** button is available only with images that have a light-colored background, like in this photo.
- The shape of the mask line can be edited by moving, adding or deleting the point of the mask line.
- It is also possible to select the mask shape from various template shapes already available.

 "Select Mask dialog box" on page 134

- Click **Fit to page (1)** to change the final finishing size.



Embroidery pattern size

Memo:

- The size of the embroidery pattern appears in the lower left corner of the dialog box. The user can change the size freely with this display.
- For best results, change the size of the embroidery pattern to the sizes listed below.
 - Face only: 100 × 100 mm
 - Head and shoulders: 130 × 180 mm

 "Check Mask Shape/Modify Image dialog box" on page 135 and "Gray Balance / Modify Image dialog box" on page 136

- Check the preview of the area to be converted then click **Next**.

Step 4 Automatically correcting the image and creating an embroidery pattern

- Click **Select from Candidates (1)**.

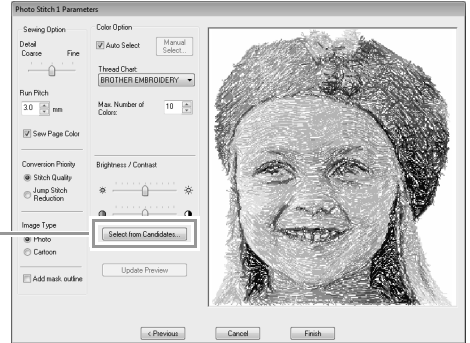

(1)

→ There are six patterns with different brightness and contrasts based on the original image.

- Select one of the candidates (1) and click **OK (2)**.

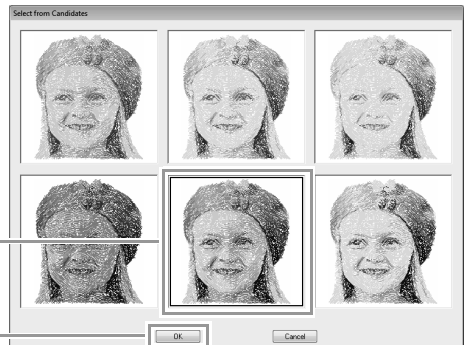

(1)

(2)

→ This preview changes to the selected image.

3 Click **Finish**.

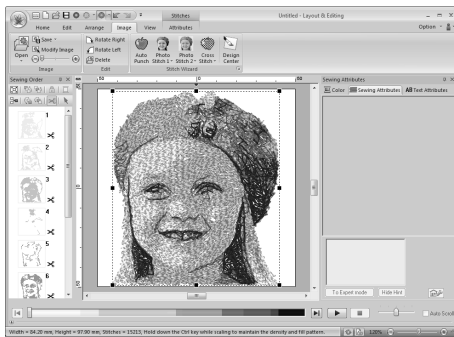

→ The image is automatically hidden.



Memo:

*If the created embroidery pattern contains colors that you do not wish to emphasize (for example, grays in the face), change the sewing order in the **Sewing Order** pane so that the undesirable color is sewn before all other colors.*



“Editing the sewing order” on page 74.

Photo Stitch 1 Features

Photo Stitch 1 Parameters dialog box

With Color, Sepia or Gray:

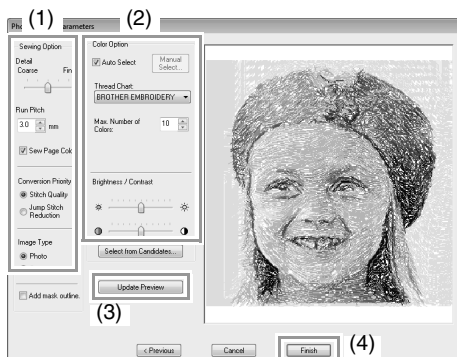

With Mono:

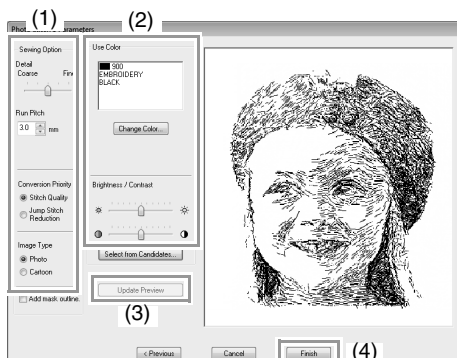

Specify the desired settings under **Sewing Option** (1) and **Color Option** (2), and then click **Update Preview** (3) to preview the effects of the specified settings. Click **Finish** (4) to convert the image to an embroidery pattern.

(1) Sewing Option

Detail	Selecting a setting closer to Fine creates more details in the pattern and increases the number of stitches. (The stitches will be overlapping.)
Run Pitch	When the value is lowered, the sewing pitch (stitch length) will be shortened, resulting in finer stitching.
Sew Page Color (Available only with Color, Sepia and Gray)	If this check box is cleared, the parts of the pattern that are the same color as the Design Page will not be sewn. If it is selected, those parts will be sewn.
Conversion Priority	To give priority to creating a pattern as close to the original photograph, select Stitch Quality . To give priority to reducing the number of jump stitches, select Jump Stitch Reduction .
Image Type	If Photo is selected, the thread colors will be mixed together, which will result in a more natural look. If Cartoon is selected, the thread colors will not be mixed together, which will result in a more simply colored look. Select Photo for image data from a photograph, etc. Select Cartoon for image data from an illustration, etc.
Add mask outline	If this check box is selected, line data is created from the mask outline.

(2) Color Option

Color/Sepia/Gray	
Auto Select	Select this check box to automatically select the thread colors.
Manual Select	Appears when the Auto Select check box is cleared. Click this button to open the Manual Select dialog box (see below).
Thread Chart	Selects the thread chart for selecting the thread color with the Auto Select function.
Max. Number of Colors	Sets the number of colors selected by the Auto Select function.
Mono	
Change Color	Click this button to display the Thread Color dialog box, where the thread colors can be changed.
Color/Sepia/Gray/Mono	
Brightness / Contrast	The top slider is used to adjust the brightness. The bottom slider is used to adjust the contrast.
Select from Candidates	 <i>Step 4, "Automatically correcting the image and creating an embroidery pattern", on page 123.</i>
Update Preview	Update the previewed image after settings have been changed.



Memo:

About the **Manual Select** dialog box

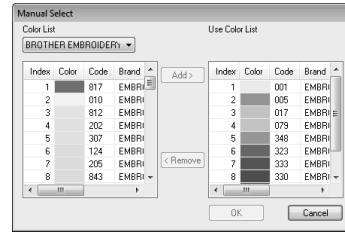

- From this dialog box, the thread color to be used with Photo Stitch 1 can be selected manually.
- To move the color selected in the **Color List** to the **Use Color List**, click **Add**.
- To delete the color selected in the **Use Color List**, click **Remove**.
- The thread colors in the **Color List** and **Use Color List** are listed, in order, starting from the brightest. This order is the sewing order and cannot be changed.



Memo:

Creating beautiful photo embroidery

- The following types of photos are not appropriate for creating embroidery patterns.
 - Photos where the subject is small, such as in photos of gatherings
 - Photos where the subject appears dark, such as photos taken in a room or taken with backlighting
- An image with a width and height between 300 and 500 dots is suitable.

Tutorial 6-3: Photo Stitch 2

We will create an embroidery pattern with Photo Stitch 2 in a method different than that used with Photo Stitch 1.

Step 1	Importing photo data into Layout & Editing
Step 2	Starting the Photo Stitch 2 wizard
Step 3	Applying an image mask and adjusting its size and position
Step 4	Changing the sewing angle

Step 1 Importing photo data into Layout & Editing

Select the **Tutorial_6** folder, and then select **girl2-face.bmp** as the image.

“Importing image data into Layout & Editing” on page 119

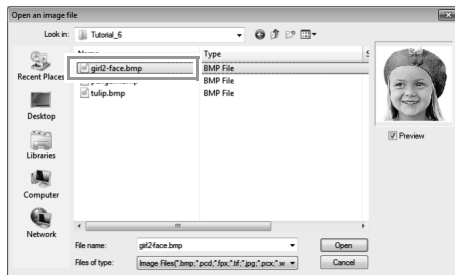

Step 2 Starting the Photo Stitch 2 wizard

Click **1**, then **2**, then **3**.

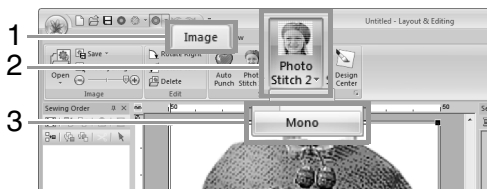

Step 3 Applying an image mask and adjusting its size and position

- 1 Click **1** to select the circle mask. Drag handle **2** to adjust the size of the mask, and drag the mask to adjust its position.

Click **Next**.



“Select Mask dialog box” on page 134

- 2 From this dialog box, the size and position of the image can be adjusted. For this example, we will simply continue to the next step.

Click **Next**.

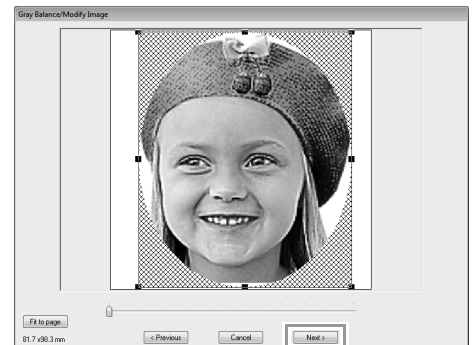

“Check Mask Shape/Modify Image dialog box” on page 135 and “Gray Balance / Modify Image dialog box” on page 136

Step 4 Changing the sewing angle

- 1 In the **Direction** box, type “45”.
- 2 Click **Update Preview**.

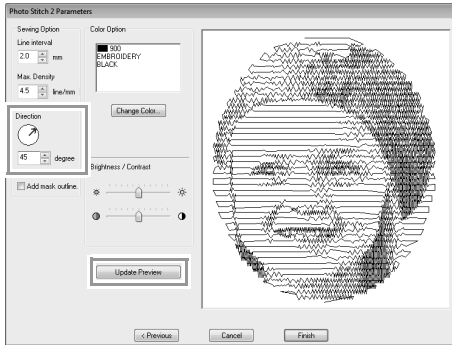

- 3 Click **Finish**.

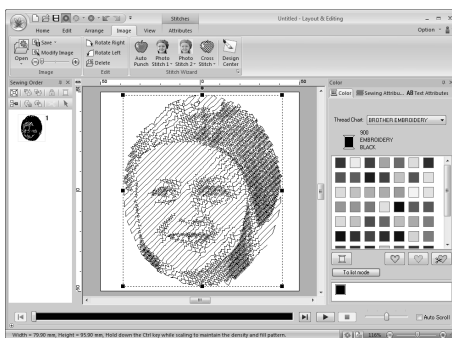
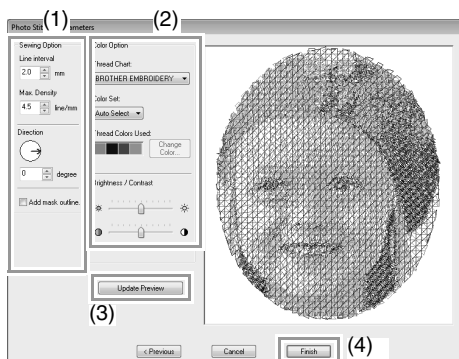

Photo Stitch 2 Features

Photo Stitch 2 Parameters dialog box

With Color:





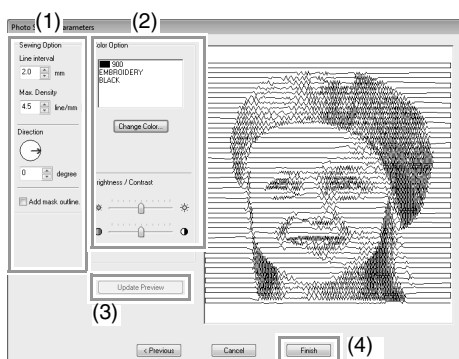

With Mono:

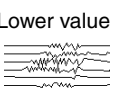
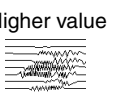

Specify the desired settings under **Sewing Option** (1) and **Color Option** (2), and then click **Update Preview** (3) to preview the effects of the specified settings. Click **Finish** (4) to convert the image to an embroidery pattern.

(1) Sewing Option

Line interval	
Max. Density	<div style="display: flex; justify-content: space-around;"> <div style="text-align: center;"> <p>Lower value</p>  </div> <div style="text-align: center;"> <p>Higher value</p>  </div> </div>
Direction	<div style="display: flex; justify-content: space-around;"> <div style="text-align: center;"> <p>0°</p>  </div> <div style="text-align: center;"> <p>45°</p>  </div> <div style="text-align: center;"> <p>90°</p>  </div> </div>
Add mask outline	If this check box is selected, line data is created from the mask outline.

(2) Color Option

Color	
Thread Chart	You can select the brand of thread to use with the Color Set function.
Color Set	<p>If Auto Select is selected, the most appropriate four colors will automatically be selected.</p> <p>Selecting a different option specifies the four colors used when creating the embroidery pattern.</p> <p>The color choices are: cyan (C), magenta (M), yellow (Y), black (K), red (R), green (G) and blue (B). Select one of the following combinations that contains the colors most used in the image.</p> <p>Color combinations: CMYK, RGBK, CRYK, BMYK</p>
Thread Colors Used	Displays the four selected thread colors.
Change Color	Under Thread Colors Used , click a color. Then, click Change Color to display the Thread Color dialog box. Select the new color and click OK . The selected thread color will be applied to the image shown in the preview box.
Mono	
Change Color	Click on the Change Color button to open the Thread Color dialog box if you wish to change the color of the photo stitching. Select the color and click OK to make the color change.
Color/Mono	
Brightness / Contrast	The top slider is used to adjust the brightness. The bottom slider is used to adjust the contrast.
Update Preview	Updates the previewed image after settings have been changed.

Tutorial 6-4: Cross Stitch

Cross Stitch embroidery patterns can be created from images.

Step 1	Importing image data into Layout & Editing
Step 2	Starting the Cross Stitch wizard

Step 1 Importing image data into Layout & Editing

Select the **Tutorial_6** folder, and then select **tulip.bmp** as the image.

 *"Importing image data into Layout & Editing" on page 119*

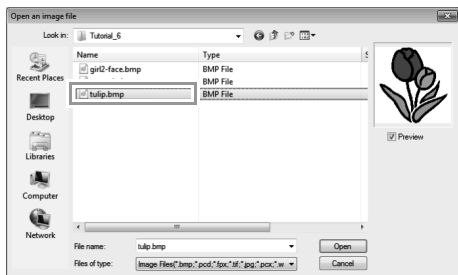

Step 2 Starting the Cross Stitch wizard

1 Click 1, then 2, then 3.

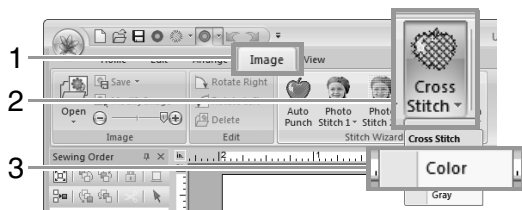

2 Click Next.

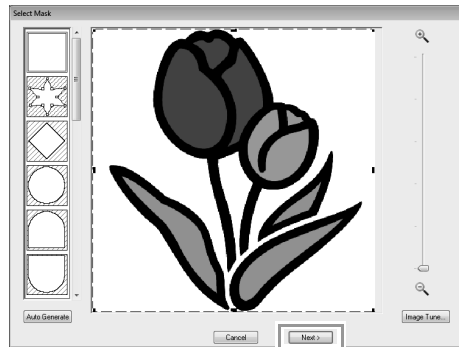

From this dialog box, an image mask can be applied and its size can be adjusted. For this example, we will simply continue to the next step.

 *"Select Mask dialog box" on page 134*

3 Click Next.

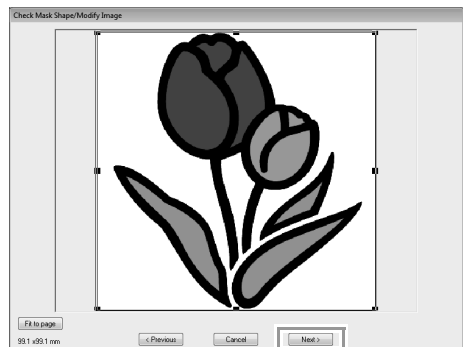

From this dialog box, the size and position of the image can be adjusted. For this example, we will simply continue to the next step.

 *"Check Mask Shape/Modify Image dialog box" on page 135*

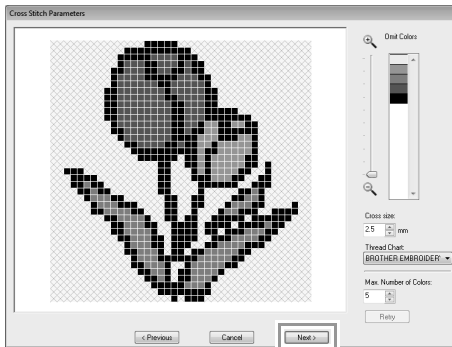
4 Click **Next**.

In this dialog box, the cross size and the number of colors can be specified. For this example, we will use the default settings.

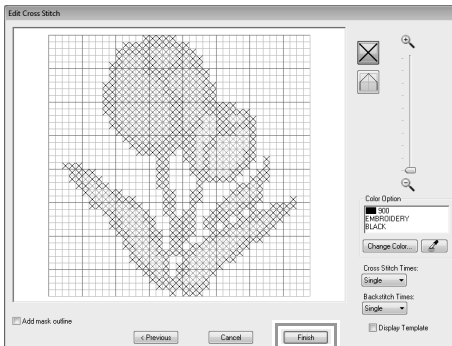
5 Click **Finish**.

In this dialog box, stitches can be added, deleted or edited, and colors and the number of times each stitch is sewn can be specified. For this example, we will use the default settings.

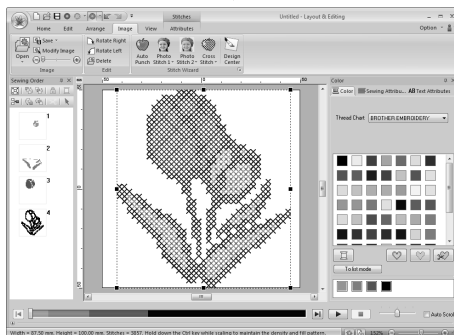

→ The image is automatically hidden.

Cross Stitch Features

Cross Stitch Parameters dialog box

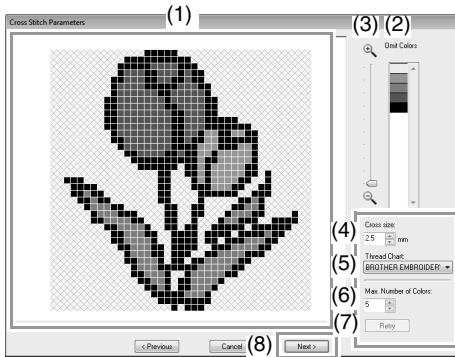

(1) Result View

Areas that will not be converted to cross-stitching are shown with a crosshatch pattern.

(2) Omit Colors

In the Omit Colors list, click the colors to select whether or not they will be sewn.



Memo:

- To select whether or not a part of the image is to be sewn, click in the preview box on the **Result View** tab, or click in the **Omit Colors** list.
- Areas filled with a crosshatch pattern on the **Result View** tab will not be sewn.

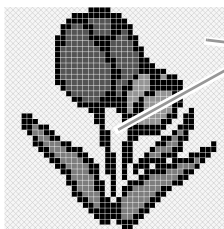

These areas will not be sewn.

(3) Zoom

(4) Cross size

Sets the size of the pattern.

(5) Thread Chart

You can select the brand of thread to use in the created cross stitch pattern.

(6) Max. Number of Colors

Sets the number of colors used in the created pattern.

(7) Retry

To view the results of the changes, click this button.

(8) Next

Continues to the next step (**Edit Cross Stitch** dialog box).

■ Edit Cross Stitch dialog box

Click a button in (1) to select the type of stitch, select a thread color in (2), and then click or drag in (3) to edit the stitches.

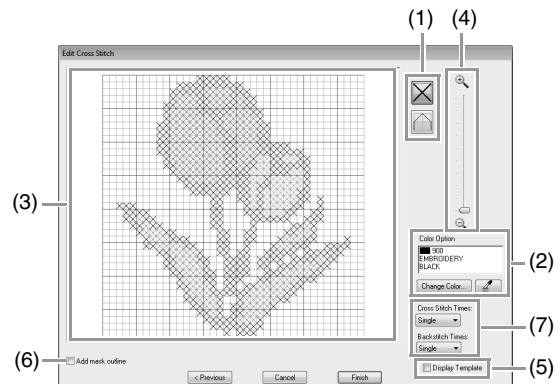

(1) Selecting stitches

Selecting stitches to be added/deleted

(cross-stitches): Specifies a cross-stitch inside a box.

(backstitches): Specifies a back stitch inside (or) or on the edge (or) of a box.

(2) Color Option

To change the color, click **Change Color** to display the **Thread Color** dialog box, and then click the desired color.

To select the color to be used for a stitch, click , and then click the stitch to be sewn with that color.

(3) Editing area

- ◆ For cross-stitches
Clicking a box: Adds one stitch.
- ◆ For backstitches
Clicking an edge of a box: Adds one stitch at the edge.
Clicking a diagonal line in a box: Adds one stitch on the diagonal.
- ◆ For both cross-stitches and backstitches
Dragging the pointer: Adds consecutive stitches.
Right-clicking/dragging with the right mouse button held down: Deletes one stitch/deletes consecutive stitches.

(4) Zoom**(5) Display Template**

To display the imported image, click **Display Template**.

(6) Add mask outline

If this check box is selected, line data is created from the mask outline.

(7) Cross Stitch Times/Backstitch Times

For the number of times each stitch is to be sewn, select **Single**, **Double** or **Triple**.

 **Note:**

*If **Previous** is clicked to return to the **Cross Stitch Parameters** dialog box after the stitches have been edited, the edited stitches are reset to their previous arrangement.*

Advanced Stitch Wizard Operations

Image To Stitch Wizard



Clicking  displays the following dialog box. If an image has been imported, the next dialog box appears.

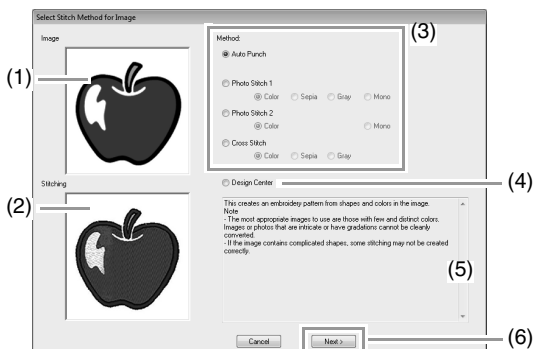

- (1) Sample image before being converted
- (2) Sample image of embroidery pattern after being converted
- (3) Select the conversion method.
- (4) Select to start up Design Center and import the image into the Design Page.
- (5) Description of conversion method
- (6) Click to continue to the next step.

Memo:

If no image has been imported into the Design Page, the **Open an image file** dialog box appears.

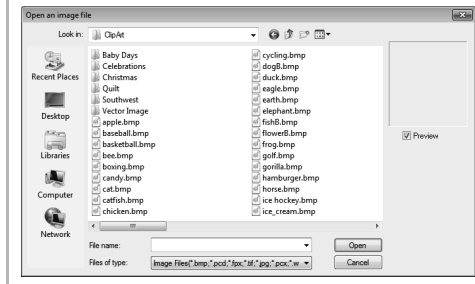

Adjusting the Mask and Image

Select Mask dialog box

The **Select Mask** dialog box appears no matter which conversion method was selected.

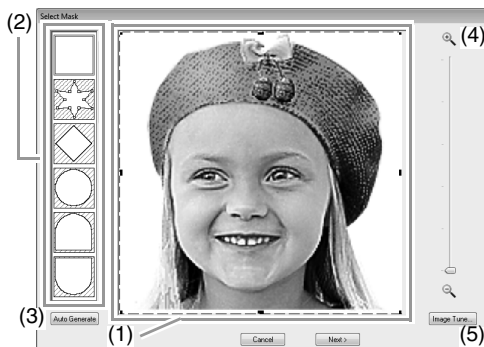



- (1) Drag the handles to adjust the shape of the mask. Drag the mask to adjust its position.

Note:

With a small original image, it may not be possible to reduce the size of the mask.

- (2) Mask shapes
The image will be masked with the selected shape.

 **Memo:**

If  is selected, points can be entered, moved and deleted to create a mask with the desired shape.
To add points, click the outline of the mask.
To move a point, select the point, and then drag it. To delete points, select the point, and then press the **Delete** key.

- (3) If **Auto Generate** was clicked,  is selected and an outline of mask was automatically detected from the image.
The **Auto Generate** button is available only with images that have a light-colored background, like in this photo.



- (4) **Zoom**
(5) Clicking the **Image Tune** button displays an **Image Tune** dialog box.

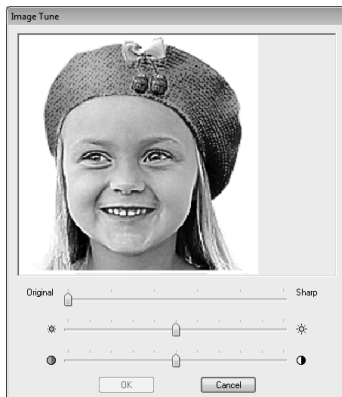

- Move the **Original – Sharp** slider to adjust the sharpness of the image's outlines. A setting more towards **Sharp** makes a more noticeable boundary between bright and dark areas.
- Move the **Dark – Bright** slider to adjust the brightness of the image.
- Move the **Low – High Contrast** slider to adjust the contrast of the image.

The next step differs depending on the color range selected for the embroidery pattern.

■ Check Mask Shape/Modify Image dialog box

If **Color, Sepia or Gray** was selected for **Photo Stitch 1, Photo Stitch 2 or Cross Stitch**, or if **Auto Punch** was selected:

The following dialog box appears.



Adjust the position and size of the image, and then click **Next** to continue to the next step.

Drag the image to move it. Drag the handles to adjust the size of the image.

- Drag the image to the desired position.
- Drag the handle to adjust the image to the desired size.

 **Memo:**

Click **Fit to Page** to adjust the image to the size of the Design Page.

■ Gray Balance / Modify Image dialog box

If Mono was selected for Photo Stitch 1 or Photo Stitch 2:

The following dialog box appears.

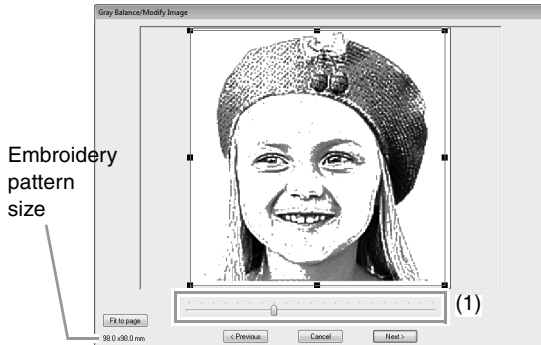

Adjust the position and size of the image and the gray balance, and then click **Next** to continue to the next step.

Drag the image to move it. Drag the handles to adjust the size of the image.

Drag the slider (1) to adjust the gray balance.

Importing to Design Center

We will create embroidery data in Design Center by using an image that was opened in Layout & Editing.

Click **1**, then **2**.

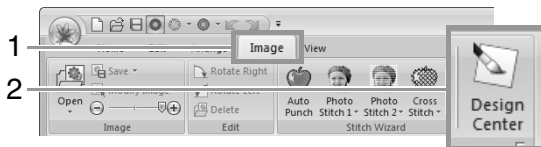

→ Design Center starts up and the image appears in the Design Page.

👉 *“Basic Design Center Operations” on page 184 and “Line Image Stage” on page 196*

Importing Image Data

An imported image can be used with the Image To Stitch Wizard, as a template for manual punching, or for printing onto iron-on transfer sheets or printable fabric when using Print and Stitch.

An image can be imported using any of the following four methods.

- From a file
- From a scanner (TWAIN Device)
- From a portrait image
- From the Clipboard



Note:

Only one image can be added to the work area. If you try to display a different image, it will replace the previous one.

Image file formats

Images in the following formats can be imported.

- Windows bitmap (.bmp), Exif (.tif, .jpg), ZSoftPCX (.pcx), Windows Metafile (.wmf), Portable Network Graphics (.png), Encapsulated PostScript (.eps), Kodak PhotoCD (.pcd), FlashPix (.fpx), JPEG2000 (.j2k), GIF (.gif)



Memo:

If an EPS file doesn't contain a "Preview" image, it can not be displayed correctly. When you create a file in EPS format, be sure to save it with preview image.

Importing image from a file

1. Click 1, then 2, then 3.

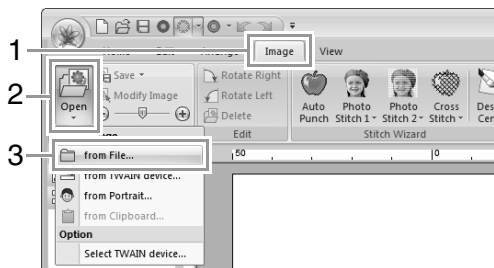

2. Select the drive, the folder and the file. Click **Open**.

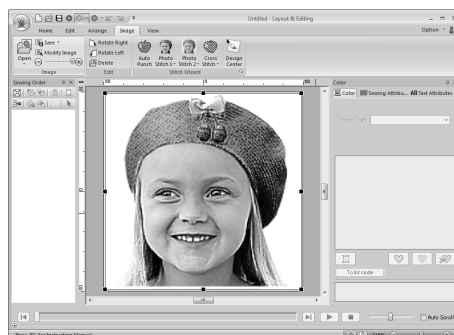
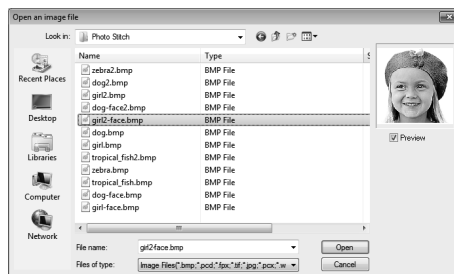



Memo:

- If the **Preview** check box is selected, the contents of the selected file will appear in the **Preview** box.
- Various clip art images can be found in the **ClipArt** folder (in the folder where **PE-DESIGN** was installed) at:
C:\Program Files (Program Files (x86))\Brother\PE-DESIGN NEXT\ClipArt

Importing image from a scanner (TWAIN Device)



Memo:

TWAIN is an application interface (API) standardization for software that controls scanners and other devices.

1. Check that the scanner or other TWAIN device is correctly connected to your computer.
2. Click 1, then 2, then 3.

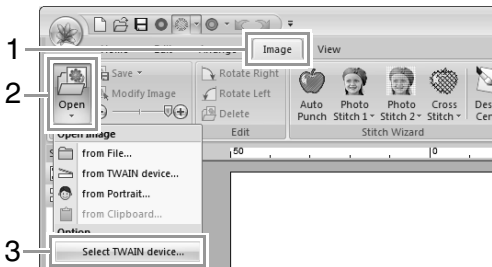

3. From the **Sources** list, click the desired device to select it. Click **Select**.

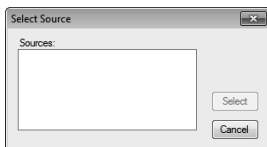

Note:

*If no TWAIN device is installed, there will be no names displayed in the **Sources** list. First, install the driver software for the TWAIN device.*

4. Click 1, then 2, then 3.

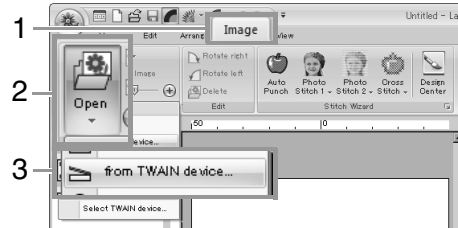

→ The driver interface for the device selected in the Select Source dialog box appears.

5. Specify the necessary settings for importing an image, and then import the image.



Note:

For information on using the driver interface, refer to the help manual for that interface, or contact the manufacturer of the interface.

→ The imported image will be pasted into the Design Page at its original size.

Creating a portrait image

1. Click 1, then 2, then 3.

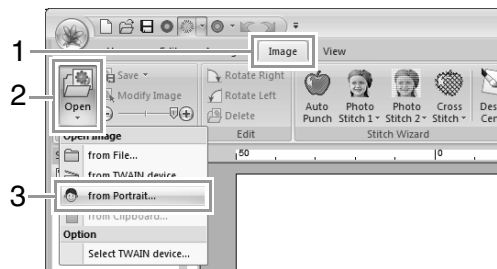

2. Specify the desired settings in the **Portrait Properties** dialog box, and then click **OK**.

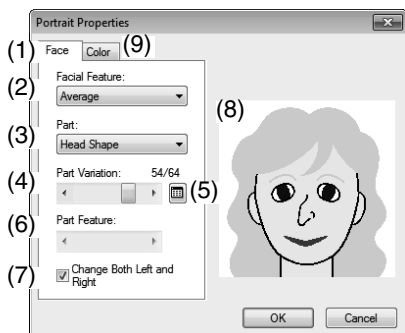

- (1) **Face** tab: Select the shape of each part of the portrait.
- (2) **Facial Feature**: Select the overall contour (appearance).
- (3) **Part**: select the part to be changed.
- (4) **Part Variation**: Select the variation for the part selected in (3).
- (5) Displays a variations list for the part selected in (3).

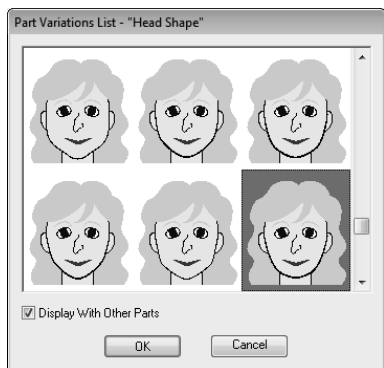

- Select a part from the list, and then click **OK**.
 - With the **Display With Other Parts** check box, select whether to display only the selected part or all parts combined.
- (6) **Part Feature**: select a part feature.
 - (7) **Change Both Left and Right**: Select whether or not the same shape is selected for the left and right eyes and ears.
 - (8) Displays the selected parts. Click a part to select it. Double-click a part to display a variations list for that part.

(9) **Color** tab: Select the color of each part of the portrait.

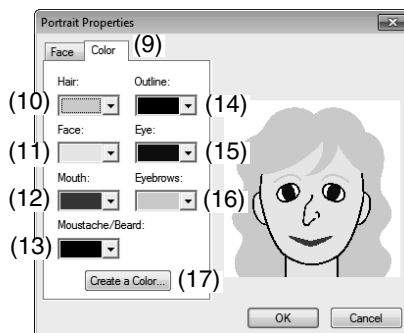

- (10) **Hair**: Select the hair color.
- (11) **Face**: Select the face color.
- (12) **Mouth**: Select the mouth color.
- (13) **Moustache/Beard**: Select the moustache/beard color.
- (14) **Outline**: Select the outline color.
- (15) **Eye**: Select the eye color.
- (16) **Eyebrows**: Select the eyebrow color.
- (17) **Create a Color**: Add a specified color to the color list selector. Specify the color in the dialog box that appeared when **Create a Color** was clicked, and then click **OK**.

→ The portrait image is displayed in the Design Page.

Importing image from the clipboard

Click 1, then 2, then 3.

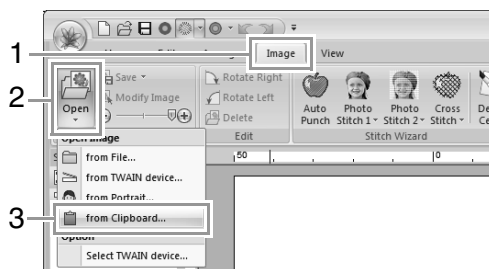

→ The image on the clipboard is imported into the Design Page.



Note:

This can only be done when there is image data on the Clipboard.

Changing the Image Settings

Adjusting the density of the background image

Click **1**, then drag the slider (**2**), or click  or

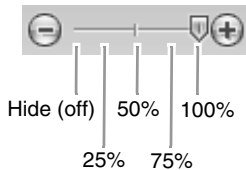
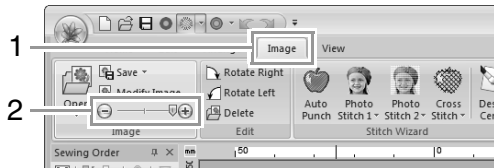

Memo:

Press the shortcut key (**F6**) to switch between displaying the image (**On (100%)**) to displaying it faded at each density (**75%**, **50%** and **25%**) to hiding the image (**Off**).

Changing the size, angle and position of the image

Selecting an image:

Click **1**, then **2**.

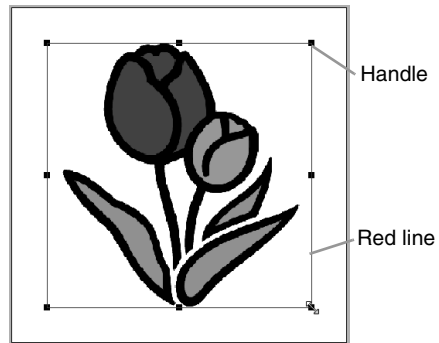
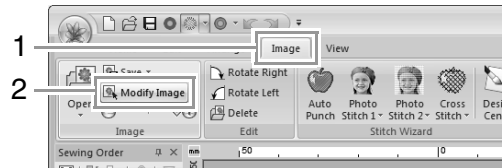

Memo:

The status bar shows the dimensions (width and height) of the image.

Moving an image:

Drag the selected image to the desired location.

Scaling an image:

Drag the handle to adjust the image to the desired size.

Memo:

If the **Shift** key is held down while a handle is dragged, the image is enlarged or reduced from the center of the image.

Rotating an image:

An image can be rotated in 90° increments.

Click 1, then 2.

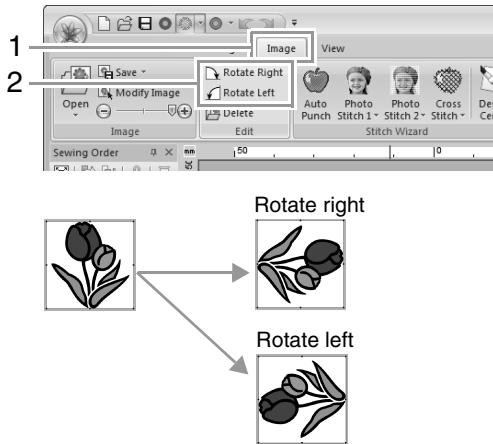

Deleting an image:

Click 1, then 2, or press the **Delete** key.

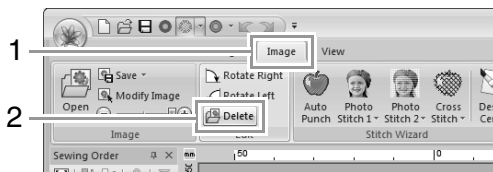

Saving the image data

■ Saving as a file

1. Click 1, then 2, then 3.

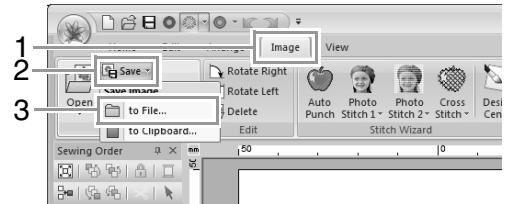

2. Select the drive, the folder and the format. Type in file name. Click **Save**.

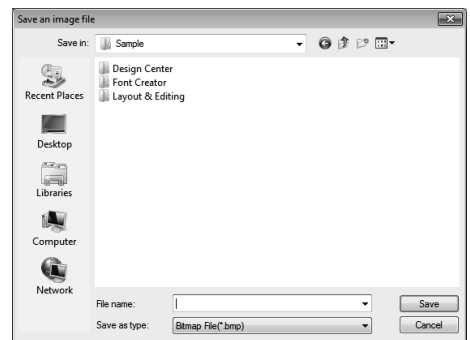

📖 Memo:

The image data can be saved in either of the following formats: Windows bitmap (.bmp), Exif (.jpg).

■ Outputting to the Clipboard

Click 1, then 2, then 3.

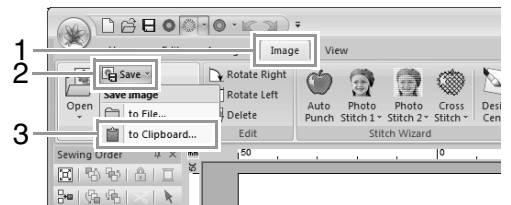

Tutorial 7: Print and Stitch

In this example, we will create a design that combines embroidery and an image.

Print the background image on fabric.

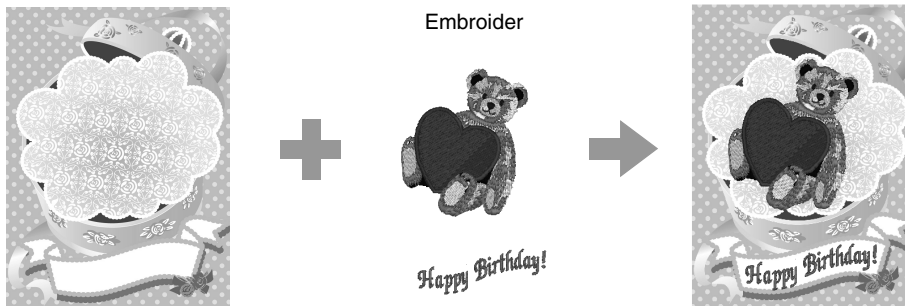

The sample file for this tutorial can be found at the following location.
Documents (My Documents)\PE-DESIGN NEXT\Tutorial\Tutorial_7

Step 1	Creating a design combined with a background image
Step 2	Printing the background image
Step 3	Printing the positioning sheet
Step 4	Embroidering

Step 1 Creating a design combined with a background image

For this example, we will use the gift box image (**Bear_Background.jpg**) and the embroidery pattern of the bear (**Bear.pes**).

- 1 Start up Layout & Editing.
Specify a Design Page size of 130 x 180 mm.
"Specifying the Design Page Size and Color" on page 85

- 2 Click 1, then 2, then 3.

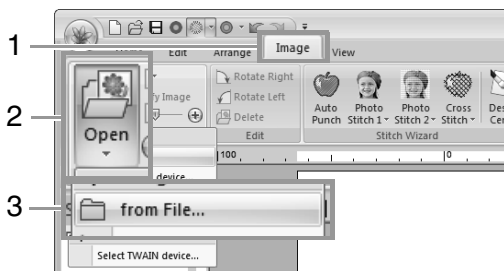

- 3 Import the file **Bear_Background.jpg**.
Select the file **Bear_Background.jpg** in the folder **Documents (My Documents)\PE-DESIGN NEXT\Tutorial\Tutorial_7**.

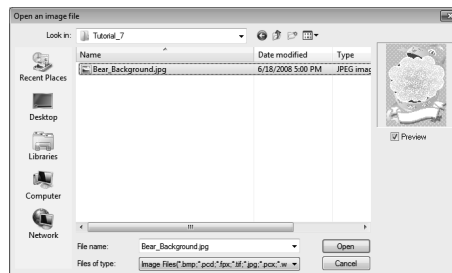

- 3 *"Importing Image Data" on page 137.*

- 4 Click 1, then 2, then 3.

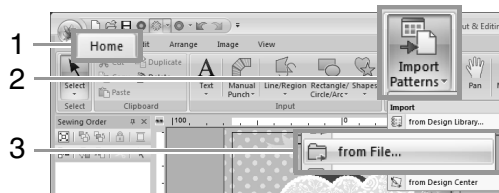

5 Import the file **Bear.pes**.

Select the file **Bear.pes** in the folder **Documents (My Documents)PE-DESIGN NEXT\Tutorial\Tutorial_7**.

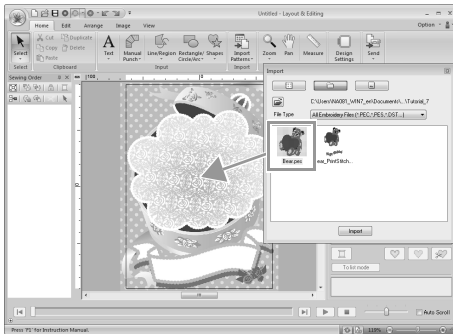

👉 *“Importing embroidery designs” on page 78*

6 Enter the text.

Select built-in font **No. 30**, and thread color **DEEP ROSE**. Type in "Happy Birthday!".

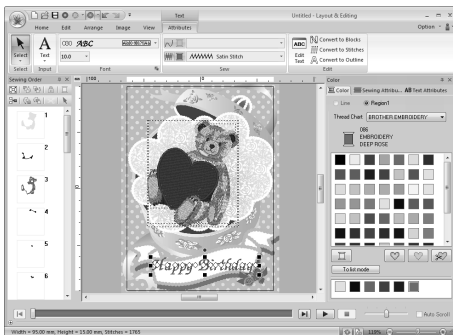

👉 *“Entering text” on page 92*

7 Transform the text to fit with the design of the image.

- (1) Click **Text Attributes** tab.
- (2) Select the **Transform** check box, and then click

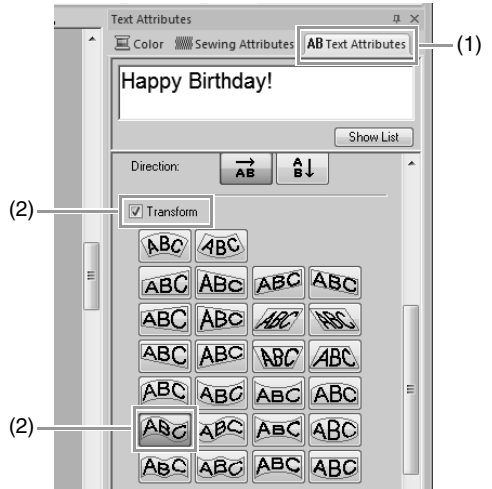

- (3) Drag the rotation handle to adjust the angle of the pattern.

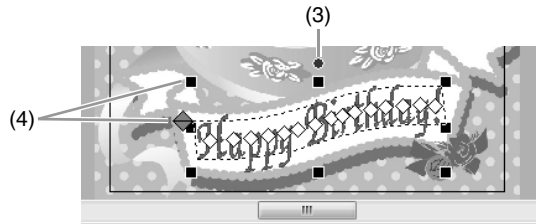

- (4) Drag or a handle to adjust the size of the pattern.

👉 *“Transforming text” on page 95 and “Rotating patterns” on page 52*

- 8 After the design is finished, save the embroidery data onto media so it can be transferred to the embroidery machine.

 For details on saving embroidery patterns, refer to “Saving” on page 81. For details on transferring designs to an embroidery machine, refer to “Transferring Embroidery Designs to Machines” on page 174.

Step 2 Printing the background image

Print the background image on an iron-on transfer sheet or printable fabric.

- 1 Click 1, then 2, then 3.

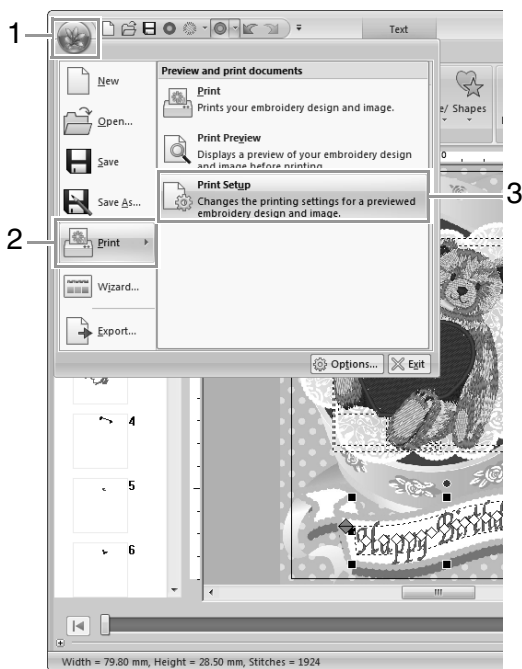

- 2 Specify the print settings.

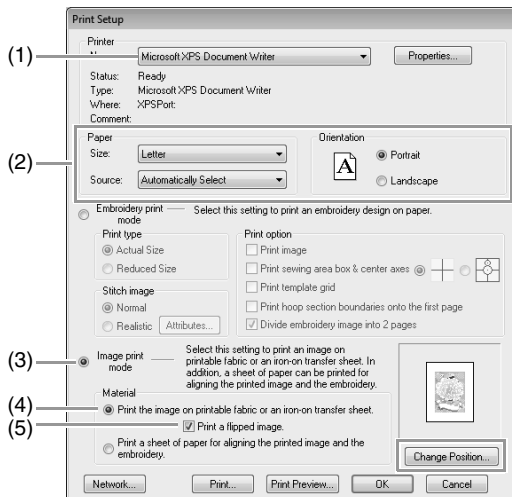

- (1) Select the printer to be used.
- (2) Under **Paper** and **Orientation**, select the appropriate settings for the iron-on transfer sheet or printable fabric to be printed on.
- (3) Select **Image print mode**.
- (4) Select **Print the image on printable fabric or an iron-on transfer sheet**.
- (5) To print a flipped image on an iron-on transfer sheet, select the **Print a flipped image** check box.
Some printers will automatically print an image flipped if an iron-on transfer sheet is selected as the paper. If this type of printer is being used, clear the **Print a flipped image** check box.
For details, refer to the instructions for the printer being used.

- 3 Click **Change Position**.

- 4 Check the image position.

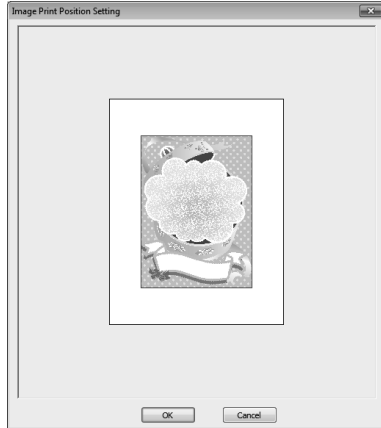

If any part of the image extends out of the print area, drag the image to adjust its position.

- 5 Click **OK**.
- 6 Click **Print**.

Memo:

To check the print image, click **Print Preview**.

- 7 Specify the appropriate settings in the Print dialog box, and then click **OK**.

"Printing" on page 82.

→ Printing begins.

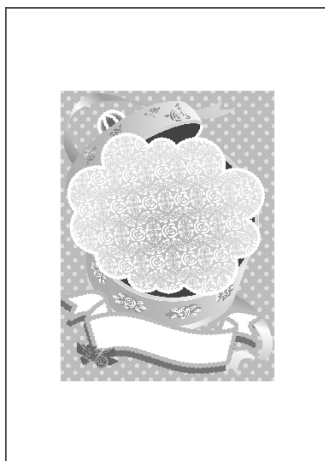

Memo:

For details on printing on iron-on transfer sheets or printable fabric, refer to the instructions for the iron-on transfer sheets and printable fabric.

Step 3 Printing the positioning sheet

Print a sheet for aligning the image and the embroidery.

- 1 Specify the print settings.

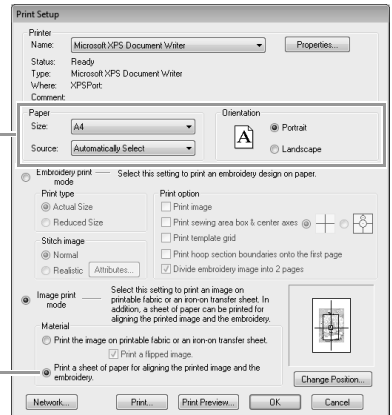

(1)

(2)

- (1) Under **Paper** and **Orientation**, select the appropriate settings for the paper to be printed on.
- (2) Select **Print a sheet of paper for aligning the printed image and the embroidery**.

- 2 Click **Print**.

- 3 Specify the appropriate settings in the Print dialog box, and then click **OK**.

"Printing" on page 82.

→ Printing begins.

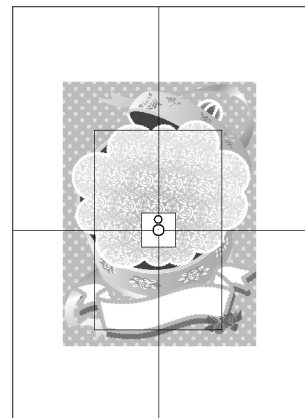

Memo:

To check the print image, click **Print Preview**.

Step 4 Embroidering

- 1 If an iron-on transfer sheet is used, transfer the image onto fabric.



Memo:

For details on transferring from iron-on transfer sheets, refer to the instructions for the iron-on transfer sheets.

- 2 Hoop the fabric in the embroidery frame.

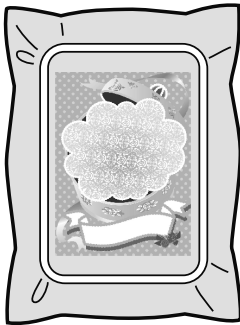

- 3 Place the positioning sheet on the fabric to be embroidered so that it is aligned with the printed image.

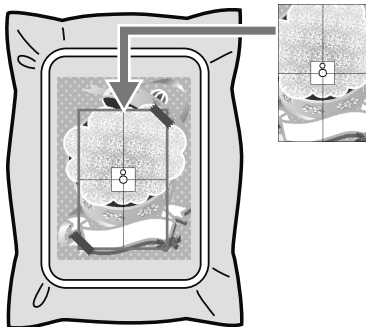

- If the positioning sheet is too large, cut it to an appropriate size so it can easily be used for aligning the positions.
 - Tape the positioning sheet to the fabric to secure it in place.
- 4 Attach the embroidery frame to the embroidery machine.
Be sure that the positioning sheet does not move out of place.

- 5 Align the needle with the mark at the center of the positioning sheet.

- If the embroidery machine has a built-in camera, press the start positioning button to detect the positioning mark and automatically align the embroidering position.
- With other embroidery machines, manually align the positions.

- 6 After positioning is finished, remove the positioning sheet from the fabric.

- 7 Start the embroidery machine to embroider the pattern.



Memo:

- For details on using the embroidery machine, refer to the Operation Manual included with the machine.
- Six patterns of completed samples for Print and Stitch are provided in the following folder.
Documents (My Documents)\PE-DESIGN NEXT\Sample\Layout & Editing\Print and Stitch

Operations for Specific Applications

This section describes operations for creating embroidery patterns using manual punching and for specific applications such as appliqués and large-sized embroidery patterns.

Manually Creating Professional-Level Embroidery Patterns (Manual Punching)

When fill stitches or satin stitches have been specified for region sewing, the angle of the stitching over the region is either all in the same direction or in a direction depending on the shape. However, if the Manual Punch tools are used, the sewing angle can be adjusted as desired to create patterns that appear more like manual embroidery.

For example, if fill stitches or satin stitches have been specified for a region with the following shape, the stitching will appear as shown below.

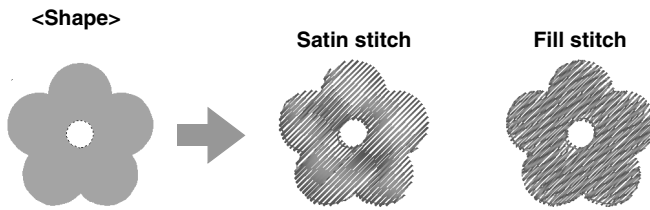

If a manual punching pattern is created using the above image as a guide, the stitching will appear as shown below.

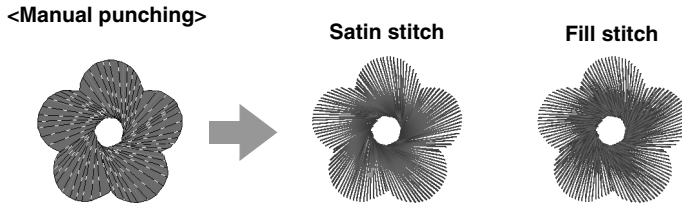

The lines drawn in the pattern show the direction of the stitching. The stitching is created so that it turns around the center of the radial stitching.

A three-dimensional appearance, like the flower petals, can be created for the flat design of this shape.

In addition, feathered edge settings can be specified for manual punch patterns. By reducing the stitch density or specifying the length of the stitching, a feathered outline can be applied to the pattern.

 Refer to "Feathered edge" in "Manual punch" on page 309

Example: Fill stitch

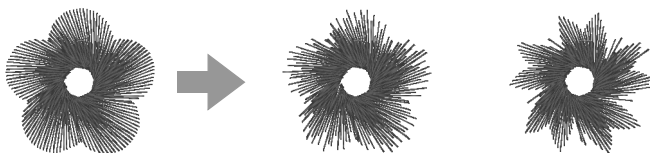

Different variations can be applied to the flower petals.

Tutorial 8: Manual Punching

The following example shows how the Manual Punch tools are used to draw a beard over the image of the reindeer (**Rudolph.bmp**), which is used as a template.

The template and finished pattern are provided in the following folder.

Documents (My Documents)\PE-DESIGN NEXT\Tutorial\Tutorial_8

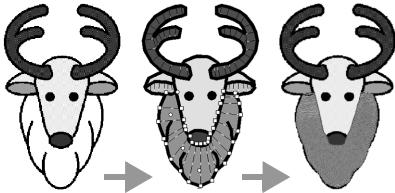

- 1 Import the file **Rudolph.bmp**.
"Importing Image Data" on page 137.

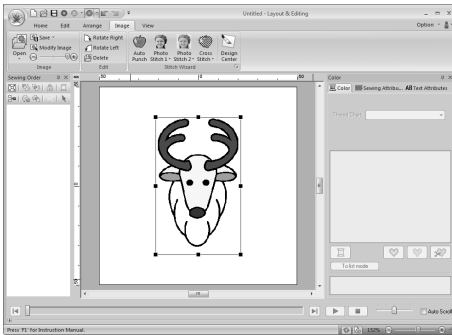

- 2 Click **1**, then **2**.

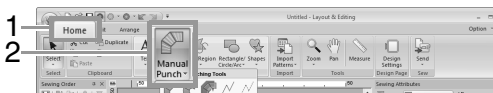

→ Five buttons appear:



- : This is used for creating straight block-type punching patterns (region sewing). (Shortcut key: **Z**)
- : This is used for creating curved block-type punching patterns (region sewing). (Shortcut key: **X**)

- : This is used for semi-automatically creating straight block-type punching patterns. By semi-automatically tracing, points can be specified along the lines of a template. (Shortcut key: **C**)

Memo:

If the semi-automatic block-type punch tool is used for drawing, an image must be imported to be used as a template.

- : This is used for creating running-type punching patterns (line sewing). (Shortcut key: **V**)
- : This is used for creating feed-type punching patterns (jump stitches). (Shortcut key: **B**)
- "Jump Stitch and Jump Stitch Trimming" on page 270.*

While creating a manual punching pattern, you can switch between the various tools. This is very easy if the shortcut keys are used.

- 3 Click to start drawing a running-type pattern.
- 4 Select **Fill Stitch** as the block sew type and **SILVER** as the punch color.

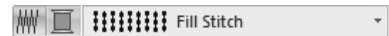

- 5 Click in the Design Page to specify points 1 (start point) through 4.

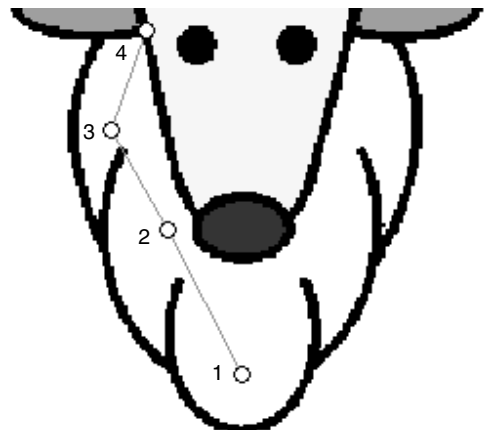



Memo:

To remove the last point that was entered, press the **BackSpace** key, or click the right mouse button.

- 6 After clicking point 4 (the last point of the running-type pattern), click , and then click in the Design Page to specify point 5 through 7.

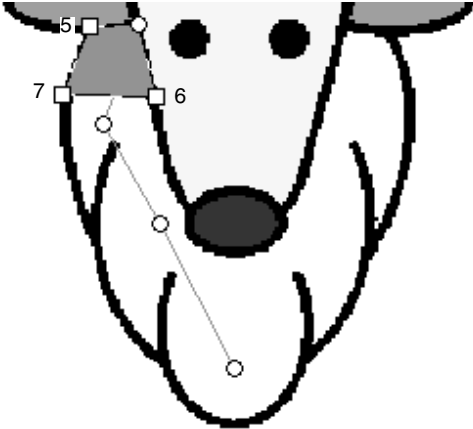

→ The area surrounded by the line is specified as a block.

- 7 Click in the Design Page to specify points 8 through 15.

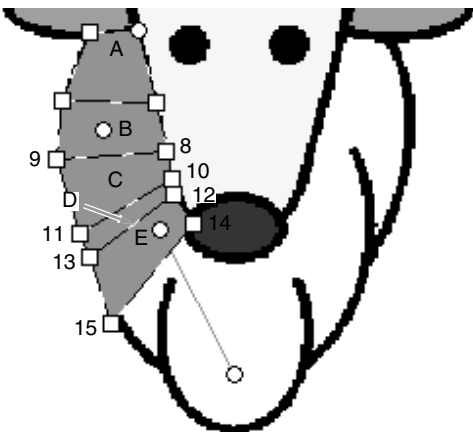

→ The blocks A through E will be created, in order.

- 8 Click in the Design Page to specify points 16 through 40.

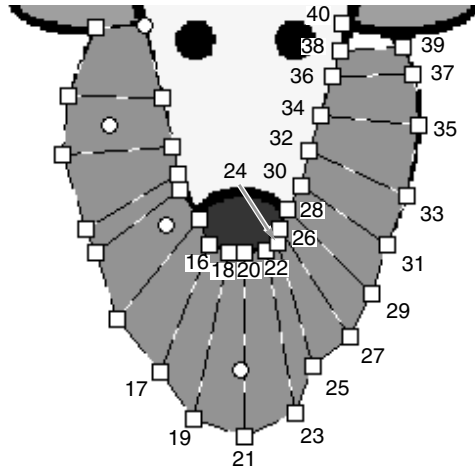

- 9 Click point 41 (the last point of the pattern), and then press the **Enter** key to complete the pattern.

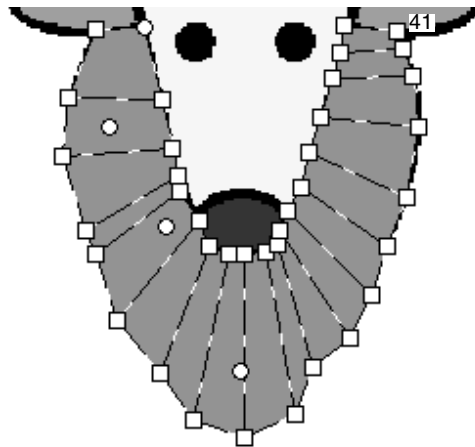

Memo:

- The pattern can also be completed by double-clicking point 41.
- Points entered with the Manual Punch tools can be edited with the Point Edit tool.



"Selecting points" on page 62.

Creating an original logo

Using the Manual Punch tools, an embroidery pattern can be created using an image of your logo in the background.

1. Open an image of the logo to be used to create the embroidery pattern.

 "Importing Image Data" on page 137

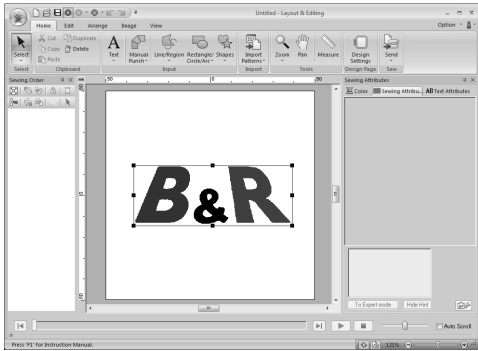

As an example, the "&" in the middle of the logo will be used to create an embroidery pattern.

Memo:

A faded copy of the background image can be displayed in the Design Page.

 "Adjusting the density of the background image" on page 140

2. First, select the Manual Punch tool. Click 1, then 2, then 3.

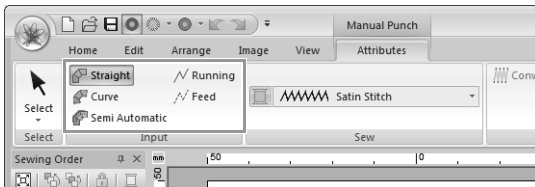
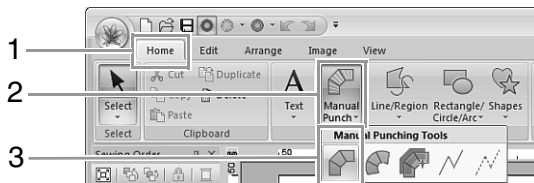

3. Click in the Design Page to specify points 1 through 4.

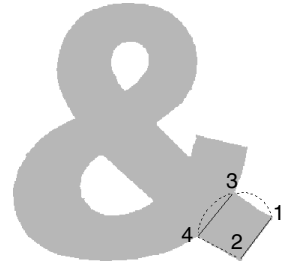

4. After specifying point 4, click  Running, and then click in the Design Page to specify points 5 through 7.

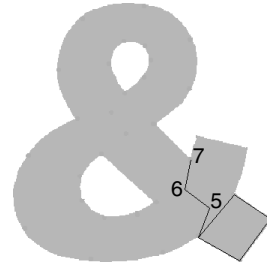

5. After specifying point 7, click  Straight, and then click in the Design Page to specify points 8 through 10.

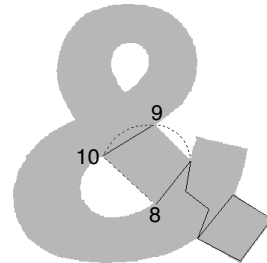

6. After specifying point 10, click  Running, and then click in the Design Page to specify points 11 through 13.

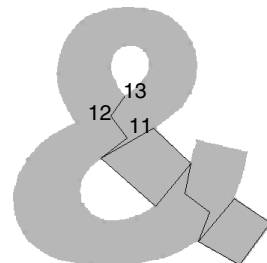

7. After specifying point 13, click  **Curve**, and then click in the Design Page to specify points 14 through 41.

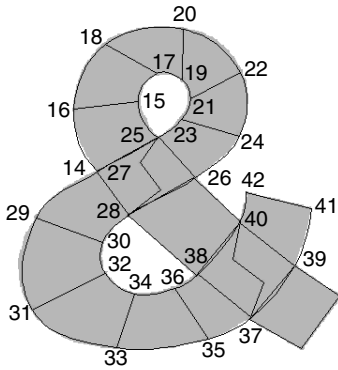

8. Click point 42 (the last point of the pattern), and then press the **Enter** key.

Tutorial 9: Creating Appliqués

The Applique Wizard provides instructions for easily creating appliqués.

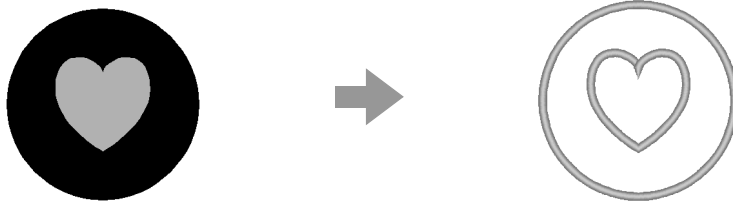

When creating appliqués, data will be specified in the following order.

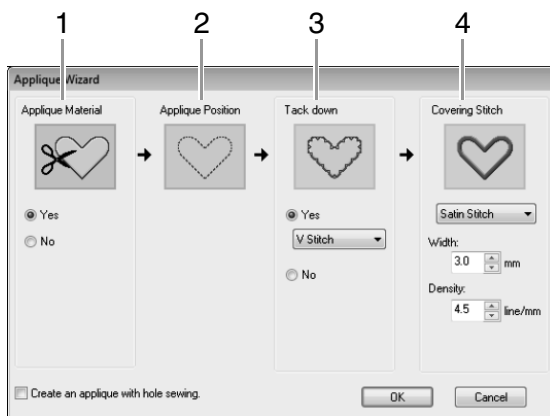

- 1 Applique Material
- 2 Applique Position
- 3 Tack down
- 4 Covering Stitch

For details on embroidering appliqués, refer to the Operation Manual included with the machine.

For this example, we will create an appliqué that has holes (empty regions).

The sample file for this tutorial can be found at the following location.

Documents (My Documents)\PE-DESIGN NEXT\Tutorial\Tutorial_9

Step 1	Creating an appliqué pattern
Step 2	Using the Applique Wizard

Step 1 Creating an appliqué pattern

An appliqué that has empty regions can be created using patterns with hole sewing applied.

- 1 Click 1, then 2, then 3, and then drag the pointer in the Design Page to draw a circle.

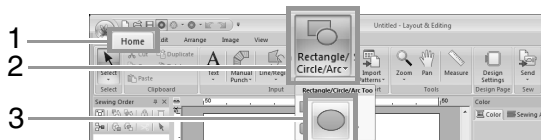

- 2 Click 1, then 2, then 3, and then drag the pointer in the Design Page to draw a heart on top of the circle.

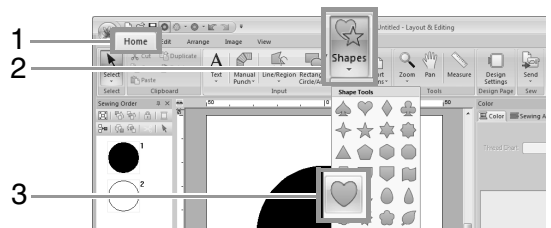

- 3 Select the two patterns, and then click **1**, then **2**, then **3** to apply hole sewing.

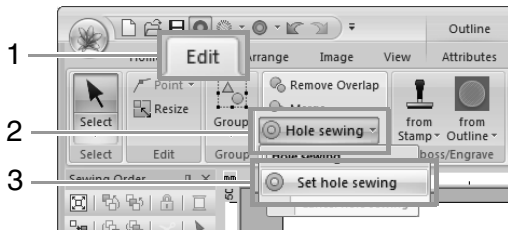

☞ “Hole sewing” on page 45.

- 4 Select the outer circle.

Note:
Be sure to select the outer pattern before starting the Applique Wizard.

Step 2 Using the Applique Wizard

- 1 Click **1**, then **2**.



- 2 Specify the desired settings in the Applique Wizard.

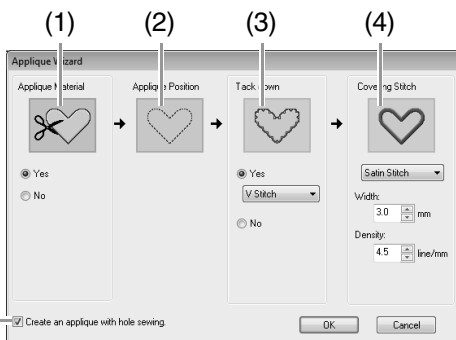

- (5) Create an applique with hole sewing
- (1) **Applique Material:** Select whether (**Yes**) or not (**No**) the outline of the appliqué is to be sewn onto the appliqué fabric as a guide for cutting it out.
- (2) **Applique Position:** Guideline for attaching the appliqué piece is set to be sewn automatically.

- (3) **Tack down:** Select whether (**Yes**) or not (**No**) the appliqué is to be basted onto the base fabric. If **Yes** is selected, you also select which stitch (Satin Stitch, E Stitch or V Stitch) to use for the basting.

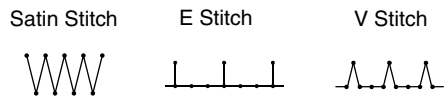

- (4) **Covering Stitch:** Select the sew type and other attributes (**Width** and **Density**) for finishing the appliqué.
- (5) **Create an applique with hole sewing:** Select this check box when creating an appliqué with holes (empty regions). (This check box appears only when an outer pattern with hole sewing applied was selected.)

For this tutorial, we will select the **Create an applique with hole sewing** check box. All other settings will remain unchanged.

- 3 Click **OK**.

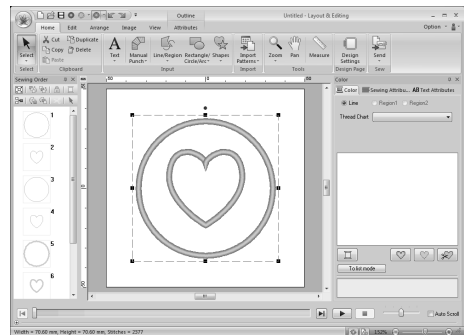

Memo:

The appliqué is indicated by diagonal lines as shown below.

 When the “**Create an applique with hole sewing**” check box is cleared

 When the “**Create an applique with hole sewing**” check box is selected

Tutorial 10-1: Creating Split Embroidery Designs

Layout & Editing has a function for creating split embroidery designs when the embroidery pattern being created is larger than the embroidery hoop.

The sample file for this tutorial can be found at the following location.

Documents (My Documents)\PE-DESIGN NEXT\Tutorial\Tutorial_10

Step 1	Specifying the Design Page size in Layout & Editing
Step 2	Creating the embroidery design
Step 3	Checking the embroidering order
Step 4	Attaching stabilizer to the fabric
Step 5	Using the Positioning Sheet, mark the embroidering position on the fabric
Step 6	Hooing the fabric
Step 7	Embroidering

Step 1 Specifying the Design Page size in Layout & Editing

- 1 Click 1, then 2.



- 2 Specify the Design Page size and the size of the design sections.

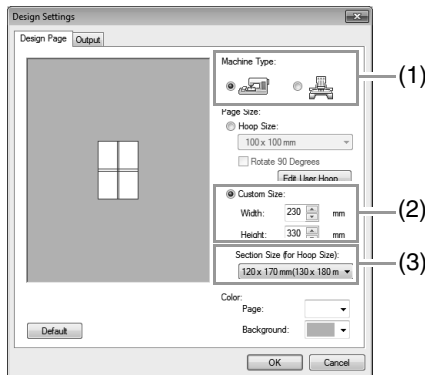

- 1 Select the type of embroidery machine to be used.
- 2 Select **Custom Size**, and then type or select the desired width and height for the Design Page. This setting is to specify the exact width and height of a design. For this example, set width to 230 mm and height to 330 mm.
- 3 Click in the **Section Size (for Hoop Size)** selector, and then select the size of the sections (your embroidery hoop). For this example, select **120 × 170 mm (130 × 180 mm)**.

Memo:

- With the **Section Size (for Hoop Size)** setting, the width and height of the sections are 10mm smaller than the actual hoop size in order to provide space for fine positioning adjustments with adjustment sections. The 10mm is for overlapping.
- It is not necessary for the **Section Size (for Hoop Size)** to match the Design Page size. Select the hoop size to be used for sewing.

- 3 Click OK.

Step 2 Creating the embroidery design

For this example, we will use one of the lace embroidery patterns provided with the software.

- 1 Click 1, then 2, then 3.

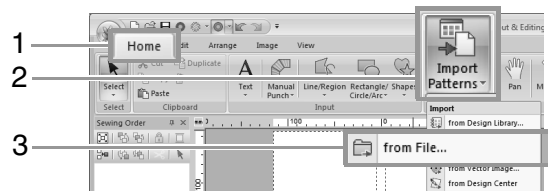

- Click , and then select the **Documents (My Documents)\PE-DESIGN NEXT\Tutorial\Tutorial_10**. Then, select the file **tutorial_10-1.pes**.

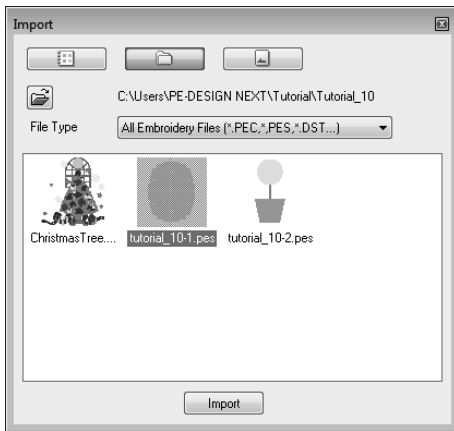

 "Importing embroidery designs" on page 78.

Step 3 Checking the embroidering order

Check the sewing order to see the order that the design sections will be sewn and determine which parts of the fabric should be hooped. The design sections are sewn in order from left to right, top to bottom.

- Click **1**.

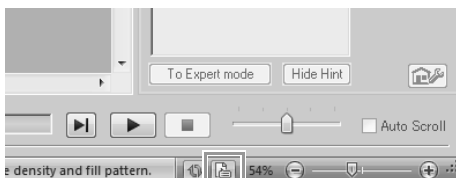

1

- Uncheck the **Show about selected Object(s)** to view the separate design sections. Click on **Next** and **Previous** to move back and forth through each section. Check the design, and then click **Cancel**.

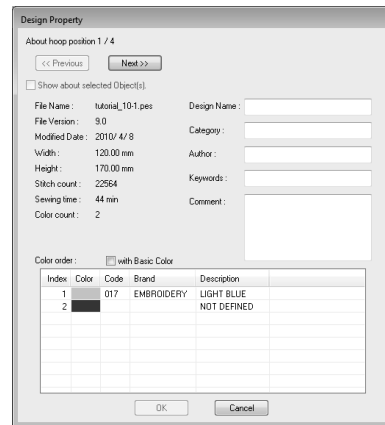

Note:

*Before an embroidery pattern created in a custom Design Page is saved or transferred to an original card, running stitches are added at the edges of the design sections so that the design sections can easily be aligned during sewing. This alignment stitching appears in the **NOT DEFINED** color and cannot be edited.*

 Memo of "Step 7 Embroidering" on page 159

Step 4 Attaching stabilizer to the fabric

Stabilizer must always be used when embroidering to stabilize the fabric. There are many types of stabilizer; the type that you will use depends on the type of fabric that you are embroidering on. For large-size designs that are split into sections, the stabilizer must be adhered to the fabric, for example, iron-on stabilizer. In some cases, you may need to use two pieces of stabilizer for your embroidery.

When using spray adhesive, spray the adhesive onto a hooped piece of stabilizer that is strong enough for the entire large-size embroidery. In some cases, you may need to use two pieces of stabilizer for your embroidery.

Note:

- For best results, attach the stabilizer to the fabric (as described on this page). Without the correct stabilizer, the design may become misaligned due to puckering in the fabric.
- Be sure to check the recommendations on the stabilizer package.

Step 5 Using the Positioning Sheet, mark the embroidering position on the fabric

Memo:

- The Positioning Sheets are included in the package.
- The Positioning Sheets are also in the **Positioning Sheet** folder and can be printed out with a printer.
- Location of the Positioning Sheets:
C:\Program Files (Program Files (x86))\Brother\PE-DESIGN NEXT\Positioning Sheet.
- The positioning sheets in the PDF files are at actual size. When printing the positioning sheet from the PDF file, be sure to print it at actual size. Do not print while reducing or enlarging to fit the paper size.

- 1 Punch a hole at the end of each arrow on the Positioning Sheet.

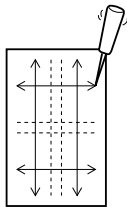

- 2 Place the Positioning Sheet on the fabric, and then insert the tip of a marking pen into each hole to mark the fabric.

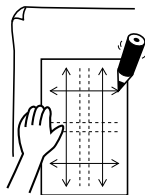

- 3 Connect the points marked on the fabric to draw reference lines.

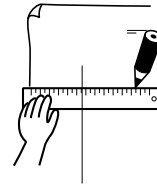

- 4 Place the Positioning Sheet on the fabric, and mark points A, B, C and D.

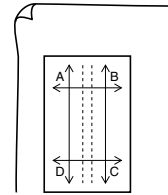

- 5 To mark an area to the right of the previously marked area, align points A and D on the Positioning Sheet with marks B and C on the fabric.

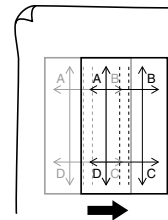

- 6 To mark an area below the previously marked area, align points A and B on the Positioning Sheet with marks C and D on the fabric.

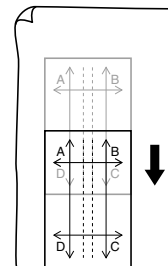

- 7 Repeat steps 5 through 6 to reposition the Positioning Sheet and draw the embroidering position for each section of the embroidery pattern.

Note:

- **The intersection of the horizontal and vertical line indicates the center of the embroidery hoop.**
- While carefully considering how the fabric will be hooped, place the Positioning Sheet on the fabric, and then draw lines to indicate the embroidering position. In addition, because all embroidery areas are not drawn on the Positioning Sheet for large embroidery hoops, be careful that the embroidery area does not extend from the marked area on the fabric as shown below.

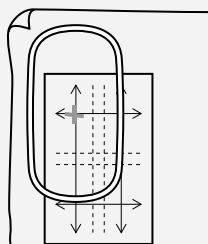

Step 6 Hooping the fabric

- 1 Insert the embroidery sheet into the inner ring of the embroidery hoop, and then place them on top of the fabric with the centerline on the embroidery sheet aligned with the reference lines (drawn on the fabric) for the first pattern section to be sewn.

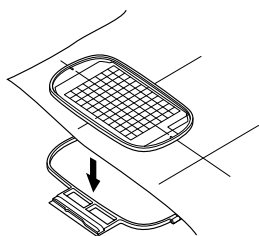

- 2 Keeping the reference lines on the embroidery sheet aligned with the reference lines for the first pattern section, place the fabric and inner ring of the embroidery hoop into the outer ring of the hoop, and then pull the fabric so that it is tight.

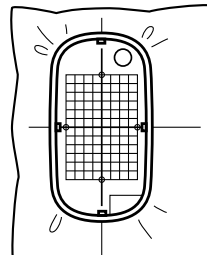

- 3 Finish hooping the fabric, and then remove the embroidery sheet.

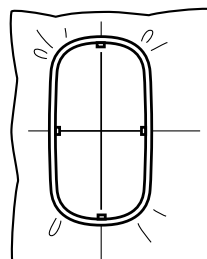

Note:

- Place the fabric and hoop on a level surface, and then make sure that the inner ring is pressed in well enough that the top edge of the inner ring aligns with the top edge of the outer ring.
- If the embroidery sheet is not used, the marks on the embroidery hoop can be used to hoop the fabric vertically and horizontally. However, since the center point on some embroidery machines is off center, the embroidery sheet should be used for best results.
- Another way to hoop the fabric is to use sticky stabilizer that can be hooped separately, tear away the protective paper, then carefully align the fabric onto the sticky surface using the embroidery sheet as a guide.
- Tip: The sticky stabilizer should be removed right away after the embroidery design is finished.
- Tip: The fabric can be hooped more easily if double-sided tape is affixed to the back of the inner ring, which is placed on top of the fabric, and then the fabric is clamped between the inner ring and the outer ring.

Step 7 Embroidering

- 1 When large-size embroidery designs are transferred to the embroidery machine, the patterns appear on the embroidery machine display as shown below. For this example, select the first embroidery pattern section (Aa).



Memo:

If there is no stitching in section Aa, select the first section that contains stitching. Click the **Design Property** button to check the embroidering order.

- 2 Attach the embroidery hoop to the embroidery machine, and then using the machine's layout adjusting functions, align the needle position with the intersection of the lines drawn on the fabric.
- 3 Embroider the selected pattern.
- 4 Remove the embroidery hoop from the embroidery machine, and then remove the fabric from the hoop.
- 5 Hoop the fabric for the next design section.

 "Hooping the fabric" on page 158

Memo:

When an embroidery design created in a custom Design Page is saved or transferred to an original card, alignment stitching (single lines of running stitches with the color **NOT DEFINED**, with a pitch of 7.0 mm, and starting with fixed stitches with a pitch of 0.3 mm) is added at the edges of the design sections. (The alignment stitching appears in the print preview and is printed in red.)

Sample data for this tutorial

- 1) Embroider the upper-left design section.
→ Alignment stitching is sewn below and on the right side of the embroidered design section.

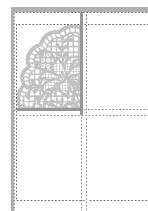

- 2) Hoop the fabric for the upper-right design section with the left side of the hoop aligned on the alignment stitching on the right side of the design section sewn in step 1, and then embroider the design.
→ Before the design section is embroidered, alignment stitching is sewn on the left side. Make sure that this alignment stitching aligns with the alignment stitching sewn in step 1. After the design section is embroidered, alignment stitching is sewn below the design section.

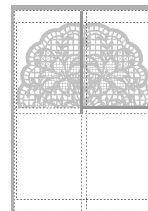

3) Hoop the fabric for the lower-left design section with the top of the hoop aligned on the alignment stitching at the bottom of the design section sewn in step 1, and then embroider the design.

→ Before the design section is embroidered, alignment stitching is sewn at the top. Make sure that this alignment stitching aligns with the alignment stitching sewn in step 1. After the design section is embroidered, alignment stitching is sewn on the right side of the design section.

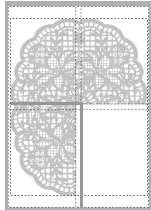

4) Hoop the fabric for the lower-right design section with the left side of the hoop aligned on the alignment stitching on the right side of the design section sewn in step 3 and with the top of the hoop aligned on the alignment stitching at the bottom of the design section sewn in step 2, and then embroider the design.

→ Before the design section is embroidered, alignment stitching is sewn on the left side and at the top. Make sure that this alignment stitching aligns with the alignment stitching sewn in step 3 and in step 2.

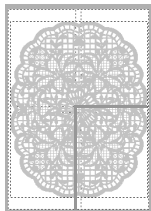

6 Continue hooping the fabric and embroidering until the entire embroidery design is sewn.

Tutorial 10-2: Creating Design for Multi-Position Hoops

This program enables you to create multi-position designs that you can stitch in any multi-position hoop attached to your embroidery machine.

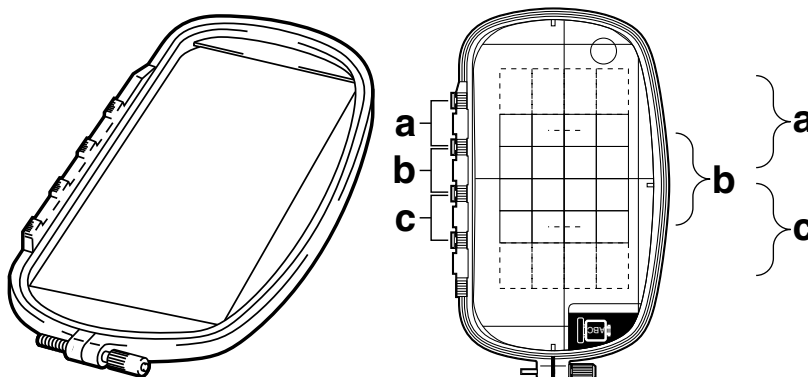

Example of multi-position hoop: 100 × 172 mm hoop

Although the size of the design that can be embroidered using an multi-position hoop is 130 × 180 mm (or 100 × 100 mm, depending on the sewing area of the embroidery machine), first determine which of the three installation positions (indicated as a, b, and c in the illustration above) the multi-position hoop will be installed at and determine the orientation of the design.

When creating the design, each design section can only be as large as the sewing area of the embroidery machine.

The sample file for this tutorial can be found at the following location.
Documents (My Documents)\PE-DESIGN NEXT\Tutorial\Tutorial_10

Step 1	Selecting the Design Page size
Step 2	Creating the design
Step 3	Optimizing hoop changes
Step 4	Checking the pattern

Step 1 Selecting the Design Page size

- 1 Click 1, then 2.



- 2 Select  under **Machine Type** (3), and then select **Hoop Size** (4) and choose a Design Page size of 130 × 300 mm or 100 × 172 mm from the selector (5). Then, click **OK** (6).

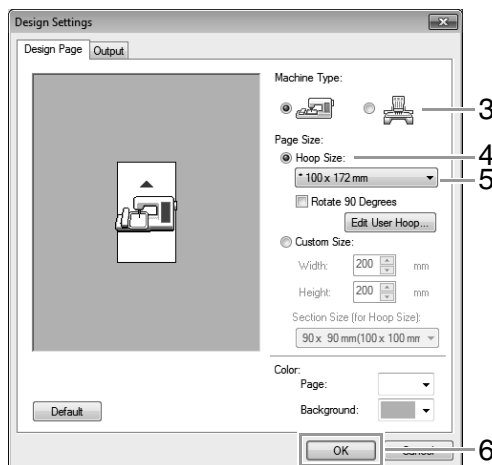



Memo:

- Settings for multi-position hoops are indicated by “*”.
- Choose the appropriate setting after checking the size of the hoop available for your machine.

Step 2 Creating the design

- 1 The Design Page appears on the screen as shown below.

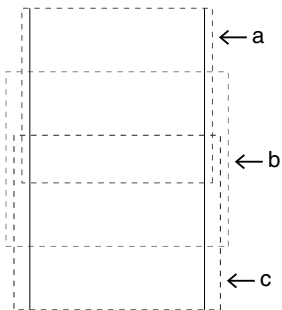

Memo:

- **Area a:** Embroidering area when the multi-position hoop is installed at the top installation position.
- **Area b:** Embroidering area when the multi-position hoop is installed at the middle installation position.
- **Area c:** Embroidering area when the multi-position hoop is installed at the bottom installation position.
The dotted lines separate each area.

- 2 Create the design, making sure that it meets the following conditions.

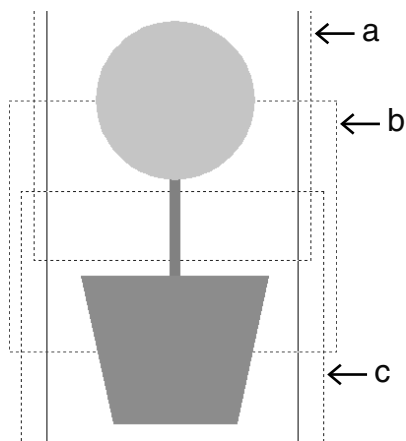

- The size of one pattern must be no larger than 100 × 100 mm (or 130 × 180 mm).
- Each pattern must completely fit within a single area (a, b, or c).



Memo:

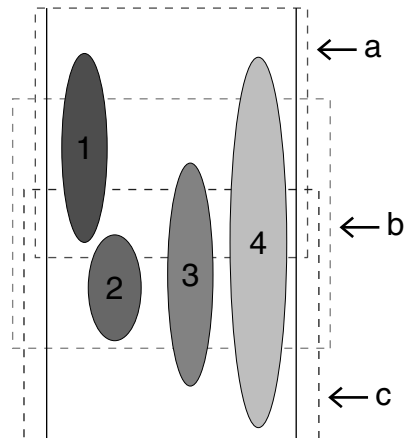

- 1: The position of this pattern is correct since it fits completely within area a.
- 2: The position of this pattern is correct since it fits completely within either area b or area c.
- 3: The size of this pattern is acceptable, but its position must be corrected since it does not fit completely within any of the areas. (It will be necessary to correct the position in order to fit in either b or c.)
- 4: This pattern must be corrected since it is too large. (It will be necessary to correct the position and size in order to fit in either a, b, or c.)

Step 3 Optimizing hoop changes

- 1 Click 1, then 2.

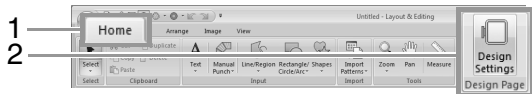

- 2 Click 1, then 2.

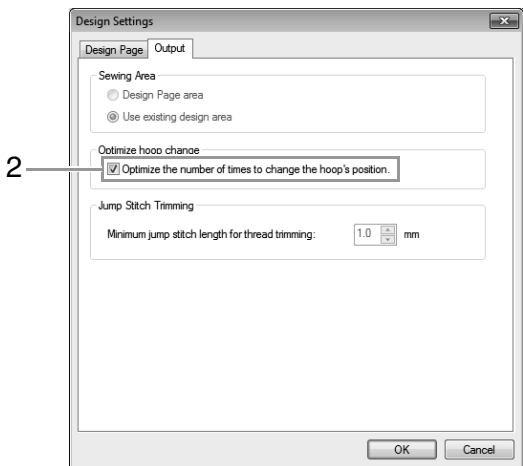
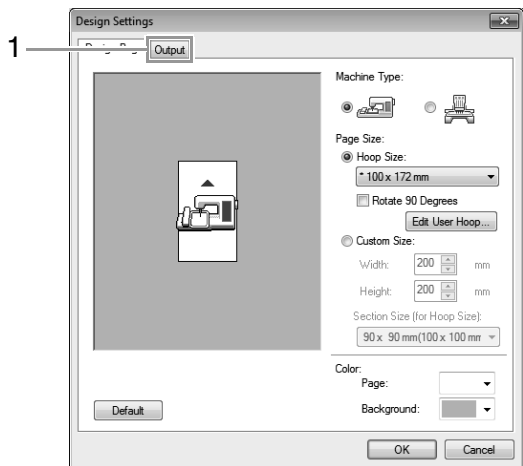

Memo:

- A check mark appears when this function is turned on; no check mark is displayed when this function is turned off.

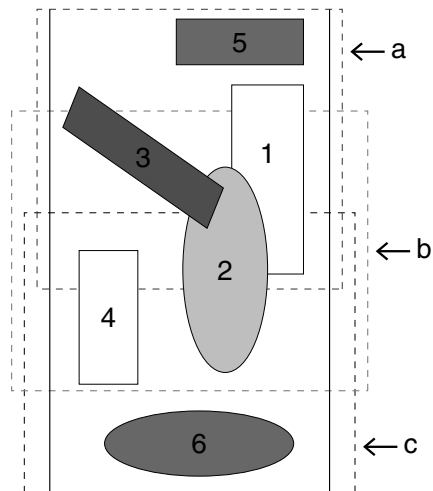

- When the Optimize hoop change function is turned on, the sewing order that you have set is optimized to reduce the number of times that the hoop installation position is changed.

For the example shown on this page, the sewing order is: a (pattern 1) → b (pattern 2) → a (patterns 3 & 5) → c (patterns 4 & 6)

If the Optimize hoop change function is turned off, each pattern is sewn according to the sewing order that you have set.

For the example shown on this page, the sewing order is: a (pattern 3) → c (pattern 4) → a (pattern 5) → c (pattern 6)

Therefore, since the number of times for changing the hoop installation position is not optimized, it may be changed more often than if it was optimized.

Note:

Since the pattern may not be sewn correctly or the fabric may not feed evenly if the hoop installation position is changed too often, we recommend turning on the Optimize hoop change function. Turning on this function will change the sewing order that you have set, therefore, check the sewing order before you begin embroidering.

Step 4 Checking the pattern

- 1 Click 1.

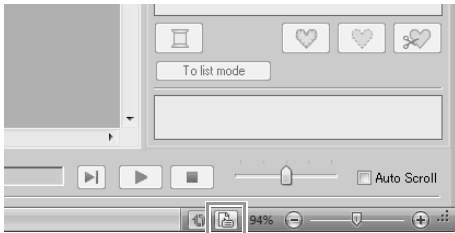

1

- 2 Check the sewing order of each pattern and the number of times the hoop position will be changed.

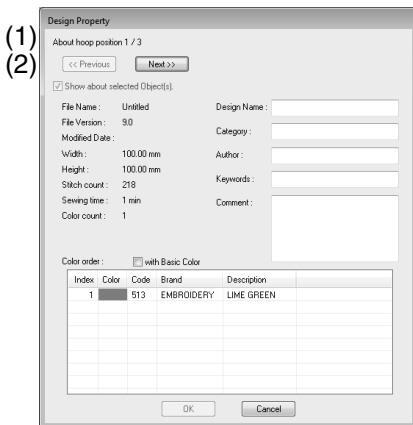

Only the patterns that would be sewn at the current position in the hoop installation order appear in the Design Page, and the embroidering area for the current hoop position is outlined in red.

- (1) The position in the hoop installation order for the currently displayed pattern.
- (2) To display information for patterns at other positions in the hoop installation order, click **Previous** or **Next**.



Note:

If a pattern is larger than the embroidery area or if a pattern is positioned so that it does not completely fit within an embroidery area, the error message appears. After the pattern causing the error is displayed, select the pattern and change its size or position.

■ Saving the design

The entire design is saved as a single file (.pes).



Memo:



If the file size or the number of color changes is larger than the specified number, or if one of the patterns does not completely fit within an embroidery area, the error message appears.

■ Writing the design to an original card

A design for a multi-position hoop is created by considering the pattern in each hoop installation position as one pattern, then combining them.

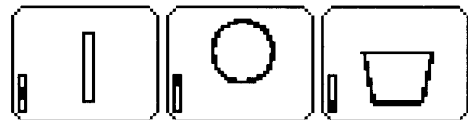
Therefore, when this type of design is written to an original card, one multi-position hoop design is saved as a combination of multiple patterns.



-  : This pattern is sewn when the hoop is installed at the top installation position (position a).
-  : This pattern is sewn when the hoop is installed at the middle installation position (position b).
-  : This pattern is sewn when the hoop is installed at the bottom installation position (position c).

Therefore, the frame installation position sewing order for the pattern shown above is b, a, then c.

Notes on embroidering using the multi-position hoop

- Before embroidering your design, sew a trial sample of the design on a scrap piece of fabric from your design, making sure to use the same needle and thread.
 - Be sure to affix stabilizer material to the back of the fabric and tightly stretch the fabric within the hoop. When embroidering on thin or stretch fabrics, use two layers of stabilizer material. If no stabilizer material is used, the fabric may become over-stretched or wrinkled or the embroidery may not be sewn correctly.
-  For more ways to stabilize large designs, refer to "Attaching stabilizer to the fabric" on page 156
- Use the zigzag stitch for sewing the outlines in order to prevent embroidering outside the outlines.



- For patterns that require the hoop to be installed at different installation positions, design the embroidery pattern so that the various parts of the pattern overlap in order to prevent misalignment while embroidering.

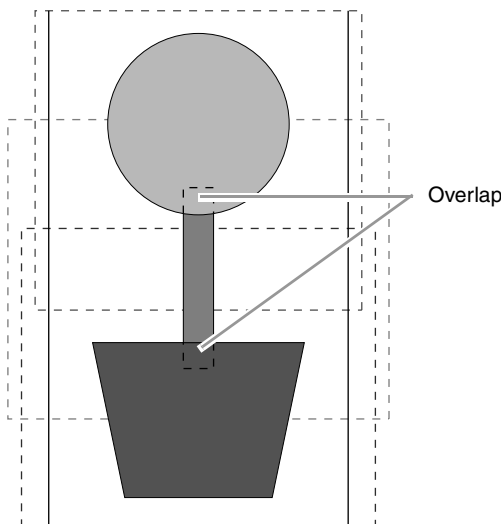

■ Printing a Design Page for a multi-position hoop

On the first page, a complete image of the Design Page is printed at actual size. (However, for a 130 × 300 mm Design Page, a reduced image of the Design Page is printed.) On the following pages, an image of each design section and its sewing information are printed in the sewing order.

When **Actual Size** is selected:

An image of the pattern in each design section is printed on a separate page as the corresponding sewing information.

When **Reduced Size** is selected:

An image of the pattern in each design section is printed on the same page as the corresponding sewing information.

 "Printing" on page 82

Tutorial 10-3: Embroidering With the Jumbo Frame

This section describes the procedures for creating embroidery data and for embroidering using the jumbo frame (frame size: 360 × 360 mm; with mounts on both sides of the embroidery frame).

Note:

- If the jumbo frame was selected, the size of the Design Page becomes 350 × 350 mm in order to create margins that allow automatic positioning using the built-in camera.
- The jumbo frame described here was designed specifically for our multi-needle embroidery machines equipped with a built-in camera. It cannot be used with any other machine, such as single-needle embroidery machines. Check the Operation Manual provided with your multi-needle embroidery machine to determine if it is compatible with the jumbo frame.

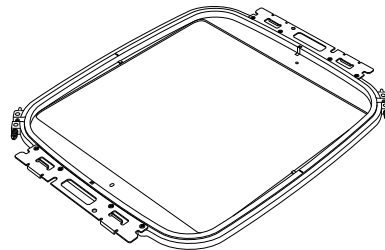

Jumbo frame: 360 × 360 mm embroidery frame

Memo:

For details on embroidering using the camera and on affixing the embroidery positioning stickers, refer to the Operation Manual provided with the embroidery machine.

Sample data that can be used in this example is provided in the following folder.

Documents (My Documents)\PE-DESIGN NEXT\Tutorial\Tutorial_10

Step 1	Selecting the Design Page size
Step 2	Creating the embroidery design
Step 3	Checking a divided pattern
Step 4	Attaching stabilizer to the fabric
Step 5	Embroidering

Step 1 Selecting the Design Page size

1 Click 1, then 2.



2 Click  under **Machine Type (3)**, select **360 × 360 mm (Jumbo Frame)** from the **Hoop Size** selector under **Page Size (4)**, and then click **OK (5)**.

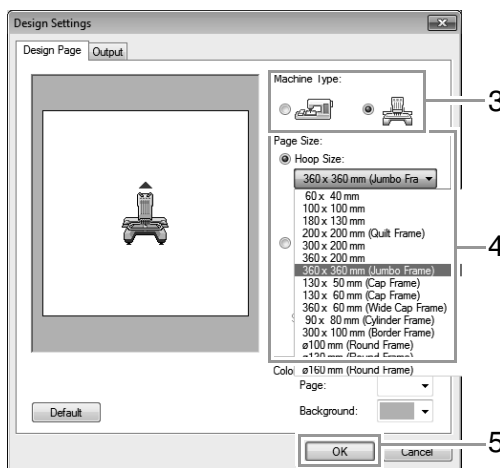

Note:

Check the size of embroidery frames that can be used with your machine before changing the setting.

- 3 The Design Page appears on the screen as shown below.

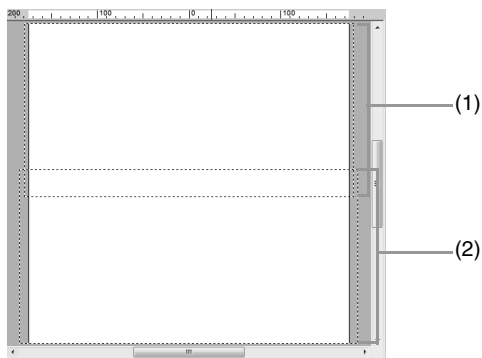

- (1) Side 1 embroidering area:
Area embroidered first
- (2) Side 2 embroidering area:
Area embroidered second

The embroidery pattern is automatically divided into the different areas.

Note:

The embroidery pattern is split with a section overlapping (1) and (2). If the pattern arranged in this section uses satin stitches, the stitch may change when the pattern is split. Therefore, we recommend shifting the pattern or changing the sew type to fill stitches.

Step 2 Creating the embroidery design

For this example, an embroidery pattern provided with this software will be used in the procedure described below.

- 1 First, import a pattern. Click 1, then 2, then 3.

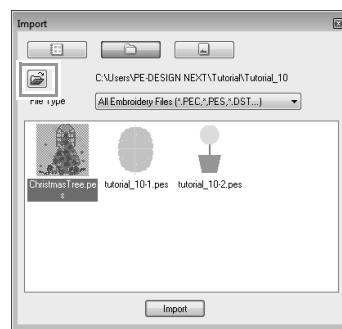
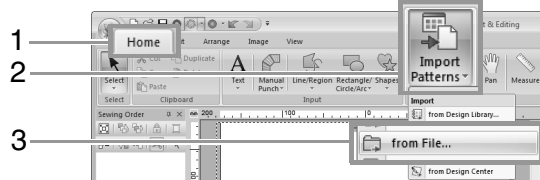

- 2 Click , and then open the following folders. **Documents (My Document)\PE-DESIGN NEXT\Tutorial\Tutorial_10** Then, select the file **ChristmasTree.pes** and import it.

Step 3 Checking a divided pattern

Before starting to embroider, the divided embroidery pattern can be checked. If a pattern that you do not wish to be divided has been split onto Side 1 and Side 2, you can check the embroidery pattern, then adjust it so it is not split.

- 1 Click 1.

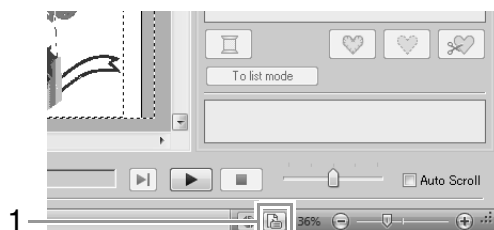

- 2 Click 1 to view the next side of the embroidery design.

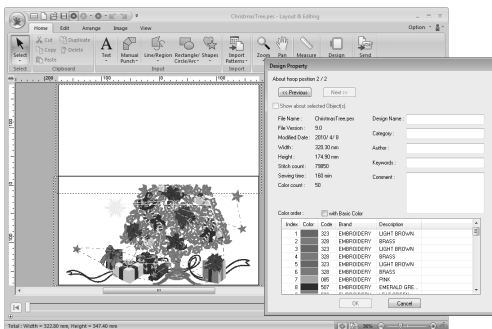
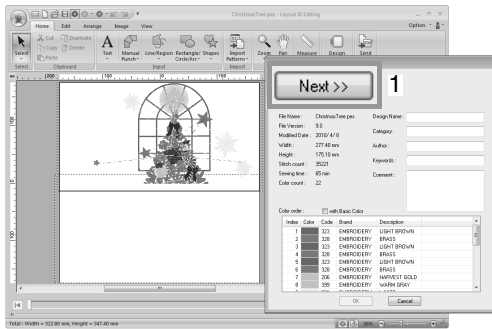

Memo:

To view the embroidery pattern click on **Design Property** to open the **Design Property** dialog box. Uncheck the **Show about selected Object(s)** to view the separate sides.



■ Saving the design

The entire design is saved as a single file (.pes).



“Transferring to a machine by using USB media” on page 175, and “Transferring directly to a machine’s memory” on page 176



Note:

An embroidery design for the jumbo frame cannot be transferred to the machine by using an original card. Transfer these designs directly to the machine’s memory or to the machine by using USB media.

Step 4 Attaching stabilizer to the fabric

Always use stabilizer when embroidering. For large designs split into sections, the stabilizer must be attached to the fabric, for example, by using iron-on stabilizer, self-adhesive stabilizer or spray adhesive. Use stabilizer appropriate for the fabric.

In addition, be sure to use stabilizer that is strong enough and large enough for the entire embroidering area. You may need to attach two layers if thin stabilizer is used.



See more information about stabilizer, “Step 4 Attaching stabilizer to the fabric” on page 156.

Step 5 Embroidering

Embroider using the embroidery positioning stickers included with the embroidery machine. These stickers are detected by the embroidery machine’s built-in camera to automatically position the fabric.

- 1 Hoop the fabric in the embroidery frame.

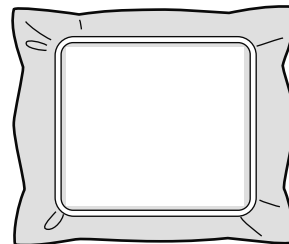

- 2 Attach the embroidery frame to the embroidery machine.
3 Select the pattern for side 1, and then start the embroidery machine to embroider the side 1 embroidering area.

- 4 When embroidering is finished, follow the instructions on the embroidery machine to affix embroidery positioning sticker on the embroidering area.

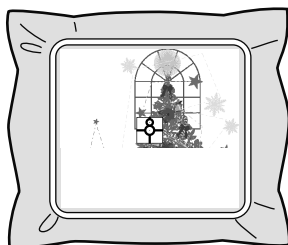

Memo:

An image of the needle location appears in the screen with the positioning detection area framed by a line.

Affix an embroidery positioning sticker so that it fits within the line. For details, refer to the Operation Manual for the machine.

→ The embroidery machine's built-in camera detects the embroidery positioning sticker.

- 5 After the sticker have been detected, remove the embroidery frame, rotate it 180°, and then re-attach it to the embroidery machine.

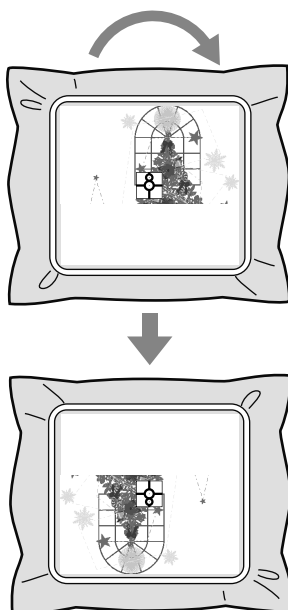

→ The embroidery machine's built-in camera detects the embroidery positioning sticker again.

- 6 Follow the embroidery machine instructions to remove the embroidery positioning stickers.

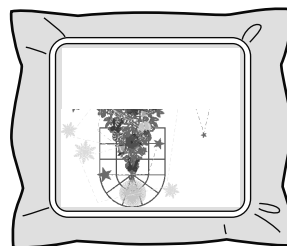

- 7 Select the pattern for side 2, and then start the embroidery machine to embroider the side 2 embroidering area.

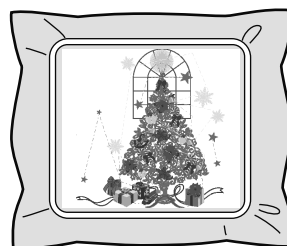

Memo:

- For details on using the embroidery machine, refer to the Operation Manual included with it.
- Carefully remove the embroidery frame and reattach it correctly. If the embroidery frame is not correctly attached or if there is slack in the fabric, the embroidery pattern may become misaligned.

■ Embroidery data for the jumbo frame



- When the embroidery design is being saved in Layout & Editing, older file format versions are not available. In addition, the embroidery design is saved as data specifically for our multi-needle embroidery machines equipped with a built-in camera. It cannot be sewn with any other machine.
- An embroidery pattern created in a Design Page set to the jumbo frame size in Design Center cannot be transferred directly to the machine. Import the embroidery pattern into Layout & Editing, and then transfer it to the embroidery machine.

Specifying/Saving Custom Sewing Attributes

Saving frequently used sewing attributes

Frequently used sewing attributes can be saved together, and recalled when specifying sewing attributes.

■ Saving the settings in a list

1. Click the **Sewing Attributes** tab.
 "Specifying sewing attributes" on page 58
2. If necessary, change the settings, and then click .
3. Click **Save As**.

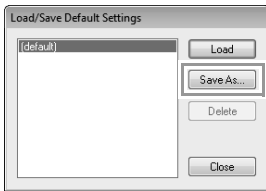

4. Type in a name for the group of settings, and then click **OK** to register the group in a list.

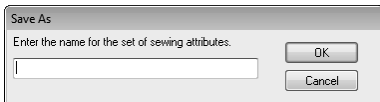

■ Deleting a group of settings from the list

1. In the **Load/Save Default Settings** dialog box, select the group of settings to be deleted.
2. Click **Delete** to delete the selected group of settings from the list.



Memo:

(default) cannot be deleted.

■ Recalling a group of settings from the list

1. In the **Load/Save Default Settings** dialog box, select the group of settings to be recalled.
2. Click **Load**.
 → The settings in the **Sewing Attribute Setting** dialog box change to the saved settings.



Memo:

- To change recalled settings and save them by replacing the original settings, click  in the **Sewing Attributes** tab, click **Save As**, and then click **OK** without changing the name for the settings.
- The saved setting can also be used on a different computer. Simply copy **sastu.txt** from **C:\Program Files (Program Files (x86))\Brother\PE-DESIGN NEXT\Settings** on the original computer to the **Settings** folder at the same path on the destination computer.
- In *Explore* click on **C:\Program Files (Program Files (x86))\Brother\PE-DESIGN NEXT\Settings**. Single left click on the **Settings** folder to view the contents. Single right click on **sastu.txt** and select **copy** from the menu. Paste to a USB device and transfer to a different computer.

Editing user thread color lists

If you have a list of thread colors that are frequently used, they can be saved in a user thread chart.

1. Click **1**, then **2**.

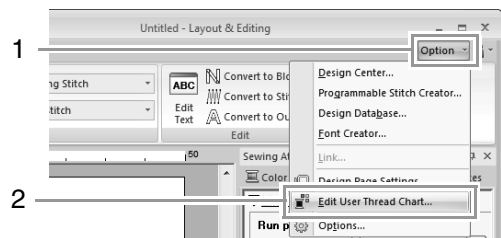

2. A user thread chart can be saved, edited or deleted.

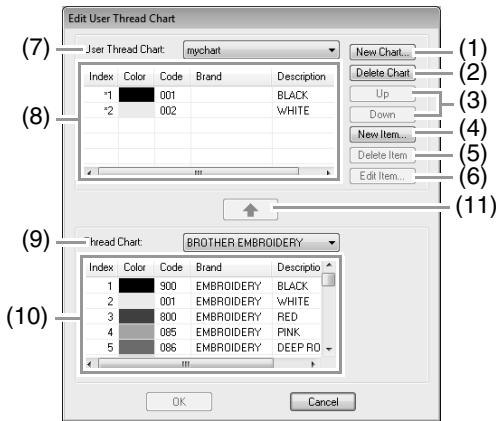

- (1) Creates a new thread chart.
- (2) Deletes a thread chart.
- (3) Changes the order of the thread colors.
- (4) Adds a new thread color.
- (5) Deletes a thread color.
- (6) Edits a thread color.
- (7) When editing or deleting a thread chart, select the thread chart here before performing the operation.
- (8) Displays thread colors in the user thread chart.
- (9) Select an existing thread chart.
- (10) Displays thread colors in existing thread chart.
- (11) Adds thread colors from an existing thread chart.

■ Creating a new thread chart

1. Click **New Chart** (1).
2. Type in the name of the chart, and then click **OK**.



Memo:
A saved chart can be selected from the **User Thread Chart** selector.

■ Deleting a chart

1. From the **User Thread Chart** selector (7), select the chart.

2. Click **Delete Chart** (2).
3. If a message appears, click **Yes**.

■ Editing a chart

1. From the **User Thread Chart** selector (7), select the chart.
2. Continue with the appropriate procedure. To save the changes, click **OK**.

■ Adding items from a thread chart

1. From the **Thread Chart** selector (9), select the brand of thread.
2. From the list (10), click the thread colors.

Memo:
To add multiple items, hold down the **Shift** or **Ctrl** keys while selecting thread colors.

3. Click  (11).
→ The selected items are added to the list in the user thread chart (8).

■ Adding a new item

1. Click **New Item** (4).
2. To create a new color, click **Mix**.



3. Specify the color, and then click **OK** to add the specified color to the **Edit Thread** dialog box.

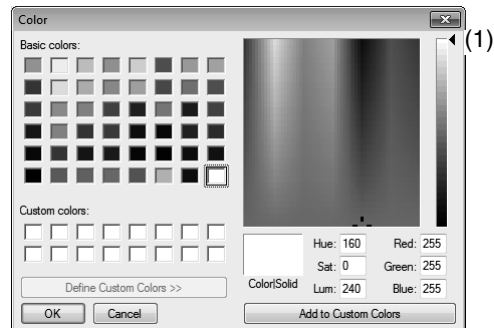



Memo:

The color cannot be changed if the slider (1) is moved to the top of the scale.

- If necessary, type in the code, brand and description into the appropriate boxes.



Memo:

Only numbers can be entered for the code.

- Click **OK** to add the new item to the user thread chart (8).



Memo:

An asterisk (*) appears in front of the index number for items created or edited by the user.

■ Deleting items

- From the list for the user thread chart (8), select the item to be deleted.
- Click **Delete Item** (5) to delete the item from the user thread chart.

■ Editing an item

An item registered in the list for a user thread chart can be edited to change the color or thread number.

- From the list for the user thread chart (8), select the item to be edited, and then click **Edit Item** (6).
- Edit the item details in the same way as adding a new item.



Memo:

As with newly added items, an asterisk (*) appears in front of the index number of edited items.

■ Changing the order of items

- From the list for the user thread chart (8), select the item to be moved.
- Click **Up** or **Down** (3) to change the order of the item.



Note:

Thread colors in embroidery patterns created with this application may appear differently on the embroidery machine, depending on the model used.

1. Embroidery machines without a function for displaying thread colors

The specified thread color information cannot be displayed at all.

2. Embroidery machines with a function for displaying thread colors

Of the thread color information specified in the embroidery pattern, only the thread color names are displayed on the machine.

However, the names that are displayed are limited to the machine's preset thread color names. Therefore, the machine displays the names of its preset thread colors that are closest to the colors specified in the embroidery pattern.

3. Embroidery machines with a thread color index

Some machines can display the thread information specified with this application. However, for thread colors that have been edited or added by the user (thread colors with an asterisk (*) at the left side), only the thread number is displayed.



Memo:

The edited user thread chart can also be used on a different computer. Simply copy **chart2.btc** from **C:\Program Files (Program Files (x86))\Brother\PE-DESIGN NEXT\Color** on the original computer to the **Color** folder at the same path on the destination computer.

Transferring Data

This section describes operations for transferring embroidery designs to embroidery machines.

Transferring Embroidery Designs to Machines

The procedures for transferring the created embroidery pattern to an embroidery machine differ depending on your embroidery machine model. For details, refer to the Operation Manual provided with your embroidery machine.

Transferring to a machine by using an original card

Designs can be transferred to an embroidery machine equipped with a card slot.



Note:

- Be sure that the hoop size of the design does not exceed the hoop that will be used on the embroidering machine.
- When writing to an original card that already contains data, all data on the card will be deleted. Before writing to a card, save all necessary data to a hard disk or other media, and check that no necessary data remains on the card.

"From an embroidery card" on page 79

- An embroidery design for the jumbo frame cannot be transferred to the machine by using an original card. This size is designed specifically for our multi-needle embroidery machines equipped with a built-in camera.

"Tutorial 10-3: Embroidering With the Jumbo Frame" on page 166

For details on writing multiple embroidery designs, refer to "Transferring Embroidery Designs to Machines" on page 217.

1. Insert an original card into the USB card writer module.

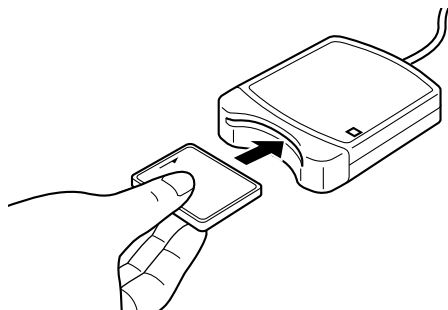

2. Click 1, then 2, then 3.

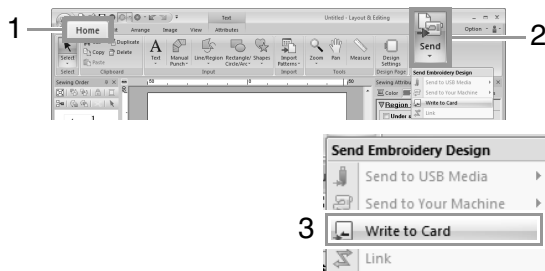

3. When the following message appears, click **OK**.

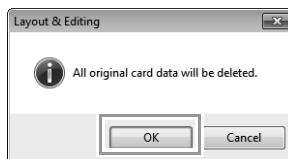

→ Data transfer begins. The following message appears while the data is being transferred.

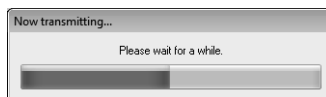

4. After the data has been transferred, the following message appears, indicating that the transfer is finished. Click **OK**.

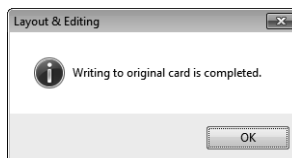

Note:

Transferring split embroidery designs
Embroidery patterns for the split patterns created on the custom-sized Design Page are written to cards split into their separate sections.

If the total size of the pattern exceeds the capacity of the media or the machine's memory or if the pattern is split into over 80 sections with a Design Page size of 90 x 90 cm (35.4" x 35.4"), you will need to split the pattern and write the separate sections onto several media.

If all pattern sections cannot be saved with a single operation, the Select Hoop Sections dialog box appears. Select pattern sections until the media becomes full.

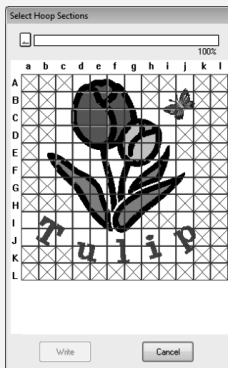

The card capacity indicator at the top of the dialog box shows the amount of space available on the card (white) and the amount of space used by the pattern sections (blue). When a pattern section is selected, the total amount of space used by the selected pattern sections appears in blue. If the capacity is exceeded, the entire card capacity indicator appears in red. To deselect a pattern section, click it again. Click Write to write the selected pattern sections to the media. (The Write button is available only when a pattern section is selected and there is sufficient space on the media for the selected pattern sections.)

For details on creating split embroidery designs, refer to "Tutorial 10-1: Creating Split Embroidery Designs" on page 155.

Transferring to a machine by using USB media

Designs can be transferred to an embroidery machine compatible with the USB Host function.



1. Plug the USB media into the computer.
2. Click 1, then 2, then 3, then 4.

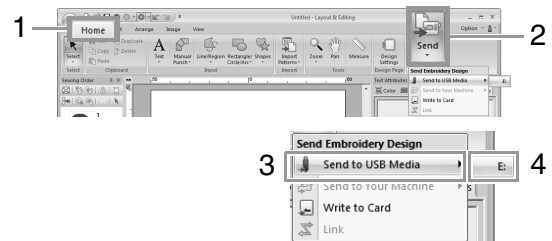

→ Data transfer begins.

Note:

If there is already a file with the same name at the destination, the following dialog box appears. Select whether to overwrite the existing file, to stop copying or to copy the file using a different name.

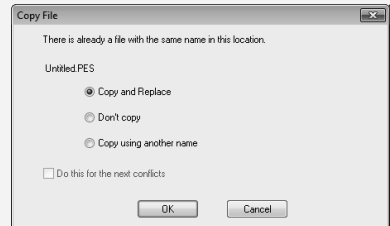

3. After the data has been transferred, the message "Finished outputting data." appears, indicating that the transfer is finished. Click **OK**, and then remove the USB media.

Memo:

If multiple USB media are connected, specify where the data is to be transferred in the area shown below.

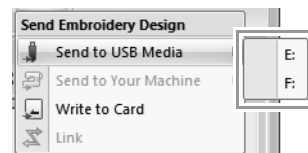

Transferring directly to a machine's memory

Designs can be transferred to embroidery machines that can be connected to a computer using a USB cable.

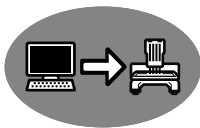

1. Connect the embroidery machine to the computer.
2. Click 1, then 2, then 3, then 4.

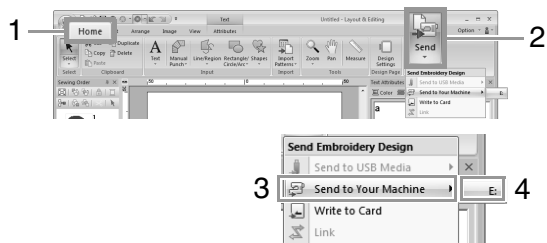

→ Data transfer begins.

Note:

If there is already a file with the same name at the destination, the following dialog box appears. Select whether to overwrite the existing file, to stop copying or to copy the file using a different name.

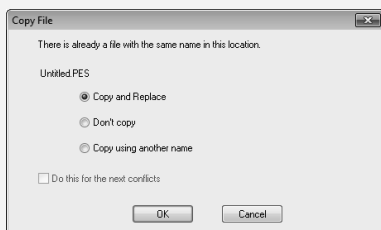

3. After the data has been transferred, the message "Finished outputting data." appears, indicating that the transfer is finished. Click **OK**.

Memo:

- For details on transferring designs with this method, refer to the Operation Manual provided with your embroidery machine.
- If multiple machines are connected, specify where the data is to be transferred in the area shown below.

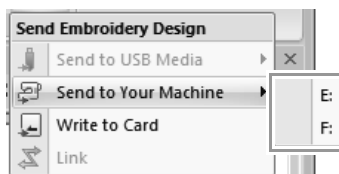

- If the connected embroidery machine has been set to Link mode, the command **Send to Your Machine**, mentioned in this procedure, cannot be selected. To select this command, return the machine to normal mode.

Using the Link Function to Embroider From the Computer

Embroidery designs can be embroidered by transferring the embroidery data from the computer to one or more embroidery machines compatible with the Link function. These embroidery designs are embroidered after the data is sent from the computer to the embroidery machine in the same way that a document is printed after the data is sent from a computer to a printer.

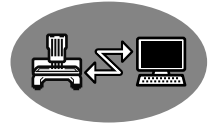

Note:

- The Link function can be used only with embroidery machines compatible with the function; it cannot be used with other machines. For details, refer to the Operation Manual provided with your embroidery machine.
- The Link function cannot be used with embroidery designs whose size exceeds the area that can be embroidered with the machine or embroidery designs in a Design Page of a custom size or for the jumbo frame.
- Up to four embroidery machines can be connected using the Link function.

1. Create an embroidery design in Layout & Editing.
2. Set the embroidery machine in Link mode.
 - Turn on the Link function of the embroidery machine, and then turn off the machine.

Note:

For details on setting the machine in Link mode, refer to the Operation Manual provided with your embroidery machine.

3. Use the USB cable included with the embroidery machine to connect the machine to the computer.
 - Turn on the embroidery machine.

Note:

- For details on connecting the machines to the computer, refer to the Operation Manual provided with your embroidery machine.
- If the machine is positioned far from the computer, we recommend you to use a self-powered USB hub. Do not use USB extension cables or repeater cables.
- Do not connect or disconnect the USB cable while the machine is turned on.
- In **Control Panel**→**Display**→**Screen Saver**→**Power**, set both **System standby** and **System hibernates** to **Never**.

Memo:

One or more embroidery machines can be connected to PC by using the Link function.

4. Click 1, then 2, then 3.

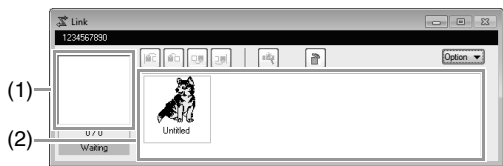
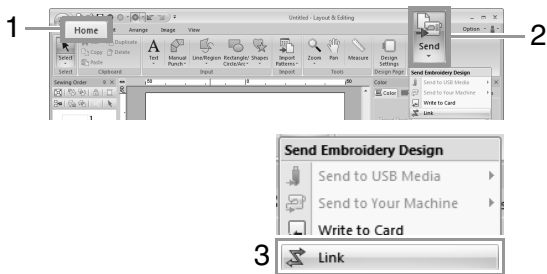

- (1) Transferred design
- (2) Queue: Displays the data before it is transferred to the embroidery machine.

→ When the machine is ready to start loading the data, data transfer begins. While the data is being transferred, a message appears in the screen of the embroidery machine, and the design moves to the transferred design area.



Note:

If the data sent from Layout & Editing does not appear in the transferred design box, continue the operation by using the machine's operation panel.

Memo:

If you want to send more than one design to the **Link** dialog, repeat step 4 for each design. The **Link** dialog will remain open while the selected design from Layout & Editing will be sent to the Link.

5. After the design has been transferred, press the start/stop button on the embroidery machine to begin embroidering.



Memo:

The transferred data cannot be edited from the embroidery machine. The received data can only be embroidered. However, embroidering settings can be specified.

When embroidering is started, the following appears in the **Link** dialog box.



- (1) Shows the status of the embroidery machine.



Each status indication is described below

Status	Description
Ready	Press the button on the embroidery machine (Start/ Stop button) to start sewing.
Waiting	If there is no data in the queue (2), select Link as the destination in the application, and send data. If this is the status even though there is data in the queue (2), continue the operation by using the machine's operation panel.
Sewing	The machine is sewing.
Paused	The machine has temporarily been stopped.
Color change	Change the thread spool on the machine.
Check thread	Check the bobbin thread or the upper thread on the machine.
Check frame	Install a different embroidery frame on the machine.
Error	Check the details of the error that occurred on the machine.

■ If multiple designs were sent to a single machine

Multiple embroidery designs can be embroidered after being sent to the **Link** dialog box. In this case, the dialog box appears as shown below.

 **Memo:**

- *Design Database is available to send multiple designs at a time.*
 -  "Sending embroidery designs to machines by using the Link function" on page 221
- **Name Drop Function** can also send multiple designs only the text is replaced.
 -  "Outputting patterns using text from the text list" on page 112

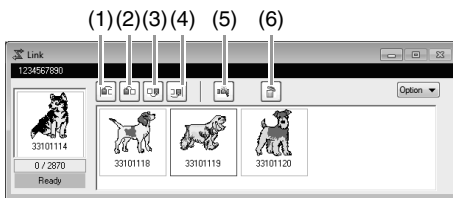

The following operations can be performed from this dialog box.

- (1) Moves the selected design(s) to the beginning of the embroidering order.
- (2) Moves the selected design(s) one position forward in the embroidering order.
- (3) Moves the selected design(s) one position backward in the embroidering order.
- (4) Moves the selected design(s) to the end of the embroidering order.
- (5) Automatically adjusts the embroidering order of the designs to reduce as much as possible the number of thread color changes.
- (6) Deletes the selected design(s) from the **Link** dialog box.

 **Memo:**

*Before the message "The machine will move. Keep your hands etc. away from the machine." appears on the machine and **OK** is pressed, the embroidering order of the designs, including the first one, can be changed since the first design has not yet been sent to the machine.*

■ If multiple embroidery machines are connected

The **Distributor** dialog box appears, in addition with the **Link** dialog box for each embroidery machine. The designs in the **Distributor** dialog will all be selected. Specify which file is to be transferred to which machine.

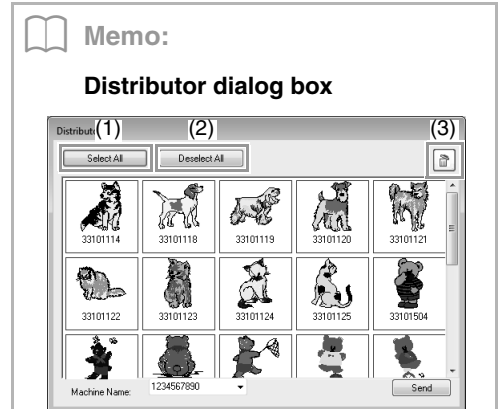

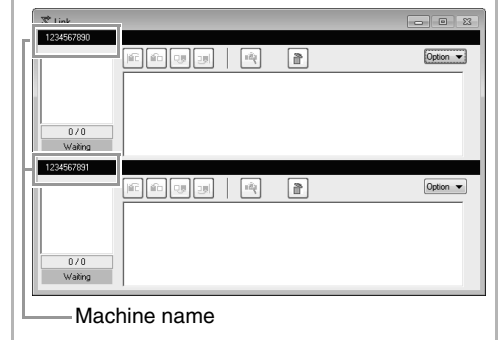

- (1) Selects all embroidery designs.
- (2) Deselects the embroidery designs.
- (3) Deletes the selected embroidery design. (The design is deleted without being moved to the Recycle Bin.)



 **Note:**

Sending a design to the Distributor dialog for multiple machines:

-  Refer to Step 4. on page 178.
-  For multiple designs to be sent, repeat Step 4. for each design.

1. Select a machine in the **Machine Name (1)** selector, select an embroidery file, and then click **Send (2)**.



2. Repeat step 1. to move each design to the **Link** dialog box.



Memo:

- The initial machine name is the machine's ID.
For details, refer to the Operation Manual provided with your embroidery machine.
- The name of the machine can be changed.
For details, refer to "Changing the embroidery machine name appearing with the Link function" on page 181

→ The embroidery designs are moved to the **Link** dialog box.

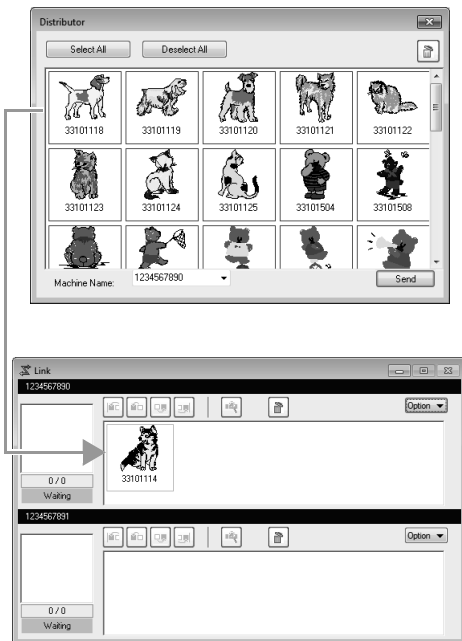

Memo:

- The embroidering order of designs in the queue can be changed.
 -  For details, refer to “If multiple designs were sent to a single machine” on page 179.
- If additional machines are connected while the **Link** dialog box is displayed, corresponding queues will appear. If a machine is disconnected, the corresponding queue will disappear.
- To display the **Property** dialog box for a file, double-click the file’s icon, or click a file to select it, right-click it, and then click **Property** from the menu that appears.
- To reduce this dialog box to a button on the taskbar, click the **Minimize** button.

To disconnect the USB cable, or shut down the computer

- After data transferring to embroidery machine and the **transferring** message on the screen of the machine is closed, you can disconnect the USB cable, or shut down the computer. When connected to the embroidery machine again, you can continue the Link operation.
- The embroidery machine can finish sewing the design currently being embroidered even if the computer is turned off.
- If the embroidery machine is turned off while it is embroidering, the resume operation can be used the next time it is turned on. At that time, transmission can be resumed using the Link function by clicking **Link** in Design Database or in the **Option** menu of Layout & Editing to display the **Link** dialog box.
- If the embroidery machine connection cannot be detected, the **Link** dialog box will close automatically.
- To display the **Link** dialog box again after the computer has been restarted, click **Link** in Design Database or in the **Option** menu (in the upper-right corner) of Layout & Editing.
- To display the **Distributor** dialog box, click **Distributor** in the **Option** menu of the **Link** dialog box.

■ Changing the embroidery machine name appearing with the Link function

1. Click **Machine Name** in the **Option** menu of the queue whose name is to be changed.



2. Type the name in the **Machine Name** box, and then click **OK**.

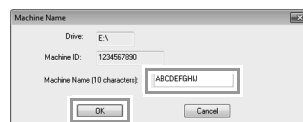

Memo:

A name (up to 10 alphanumeric characters/symbols) can be specified for the embroidery machine.

Note:

- When an embroidery machine is connected to the computer, the embroidery machine is recognized by the computer as a removable disk and is assigned a drive letter. If this drive letter is the same as one that has already been assigned by the computer, designs cannot be sent from the computer to that embroidery machine. This problem occurs, for example, if a network drive has been assigned a computer drive letter. If this occurs, cancel the assignment for the drive with the conflicting drive letter.
- When the number of embroidery machines connected to the computer via USB is increased, the operating system may require that the computer be restarted. At that time, restart the computer.





Design Center

This section describes the basic operations performed in Design Center. A simple step-by-step procedure is provided to create an embroidery pattern from a template image, such as an illustration.

Basic Design Center Operations

In Design Center, embroidery patterns can be created from an original image. In addition, you can specify colors and sewing attributes for the lines and regions that are more detailed than those specified with the Auto Punch function in Layout & Editing.

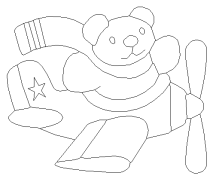
An embroidery design is created in the following four stages.

Stage 1 Original Image Stage	Stage 2 Line Image Stage	Stage 3 Figure Handle Stage	Stage 4 Sew Setting Stage
			
<p>Open an image file, and select the colors to be used for creating the outlines.</p>	<p>The original image is converted to a black-and-white line image. Outlines can be drawn or erased.</p> <p>Example: The stripes in the scarf are erased. Stripes are added to the scarf.</p>	<p>The line image is converted to a figure handle image. Points in the figure handle image can be edited to change the design.</p> <p>Example: The eyes are moved, and the facial expression is changed. A star is added to the tail of the plane.</p>	<p>The sew type and thread colors are specified in the outline to complete the embroidery design.</p> <p>Example: By applying colors different than in the original image, the design is given a different appearance.</p>
<ul style="list-style-type: none"> • If the data is saved, work can be stopped at each stage, then started again. • The most appropriate images to use are those with few and distinct colors. Images or photos that are intricate or have gradations are not suitable since it is difficult to extract their outlines. • Line image data is saved in the .pel format, and figure handle data is saved in the .pem format. • The embroidery data is saved in the .pem format. To transfer .pem data created in Design Center to an embroidery machine, import the pattern into Layout & Editing, and then transfer the data to an embroidery machine. <p> <i>"Importing into Layout & Editing" on page 192 and "Transferring Embroidery Designs to Machines" on page 174</i></p>			

This section describes the basic operations performed in Design Center. For details on the procedures or settings, refer to "Design Center Window" on page 193.

Step 1 Original Image Stage

■ Extract outlines from an image

- 1 Click  (Start), and then select **All Programs**, then **PE-DESIGN NEXT**, then **Tools**, then **Design Center**.

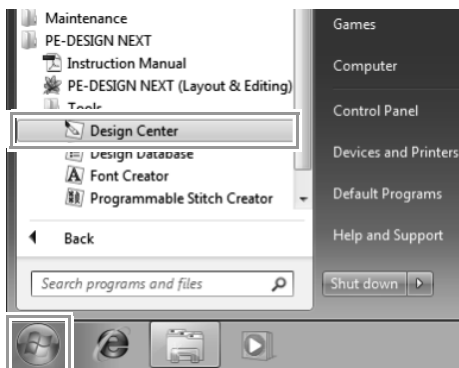

- 2 Click 1.

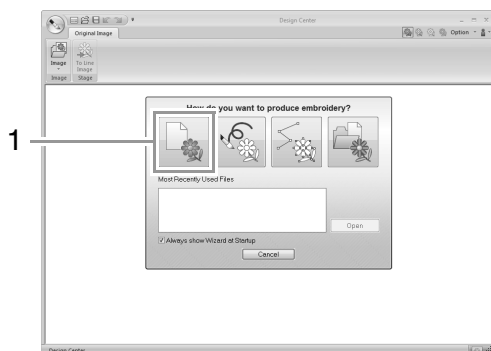

- 3 Click 1.

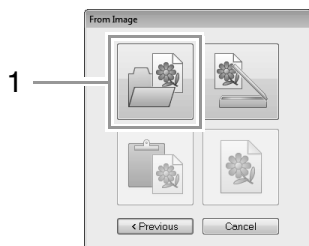

- 4 Select the desired image file, and then click **Open**.

Note:
Airplane image is located at:
**C:\My Documents\PE-DESIGN NEXT
ISampleDesignCenter.**

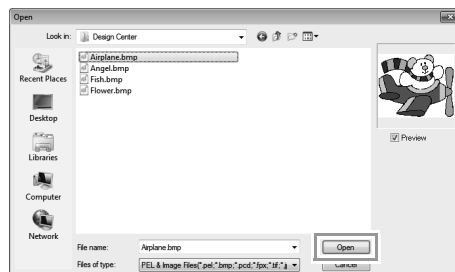

- 5 In 1, select the colors to be used for the outlines (embroidery lines).

→ The selected color appears in a box on the right side, and appears in the check box to show that the color is selected.

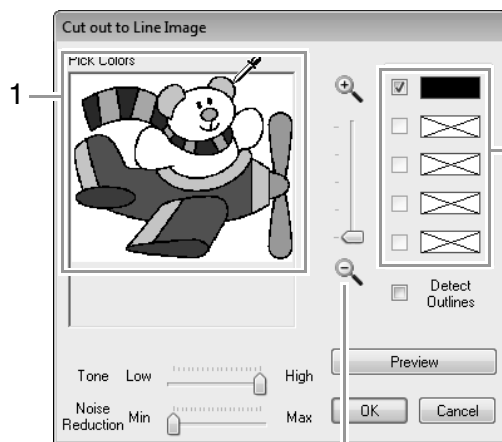

The desired color can be selected more easily if the **Zoom** slider is used to enlarge the image.

If a color other than that for the outline was selected, clear the check box beside the color to deselect it.

- 6 After selecting the colors to be used for the outlines, click **OK**.
 → The line image appears in the Design Page.

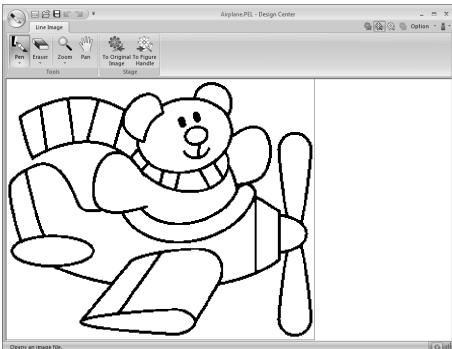

Step 2 Line Image Stage

Using the Eraser

- 1 To erase a line, select the **Eraser Tools**. Click 1, then 2.

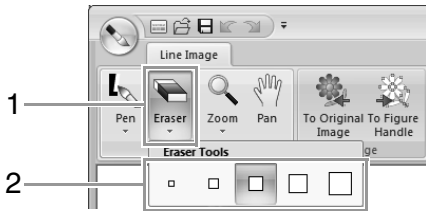

Select an Eraser tool according to the size of the area or thickness of the line to be erased.

- 2 Move the pointer over the line to be erased, and then click the line or drag the pointer to erase the line.

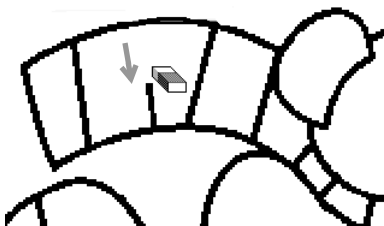

Using the Pen

- 1 To draw lines, select the **Pen Tools**. Click 1, then 2.

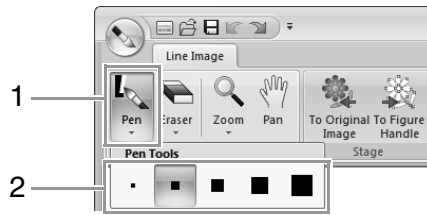

Select the Pen tool with the desired thickness of the line to be drawn.

- 2 Drag the pointer to draw a line. To add a point, click in the Design Page.

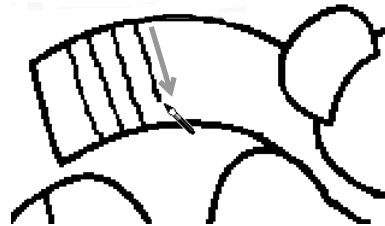

Memo:

To draw vertical or horizontal lines, hold down the **Shift** key while moving the pointer.

Memo:

- If lines are drawn or erased incorrectly, click  (Undo button) (1) to undo the last operation.
- To change the display size, use **Zoom** command (2).
- The part of the work area that is displayed can easily be changed by using the **Pan** tool (3).

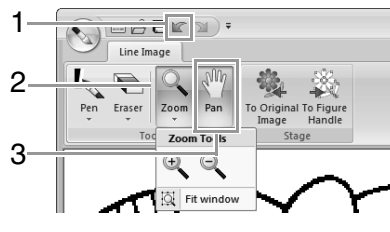

■ Editing the extracted outline

- 1 When the line image is finished, click, 1 or 2.



- 2 Click OK.

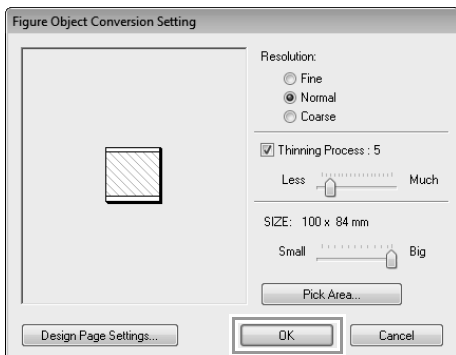

→ The line image is converted to a figure handle image.



Step 3 Figure Handle Stage

■ Moving outlines

- 1 Click 1, then 2, and then click the outline to be moved.

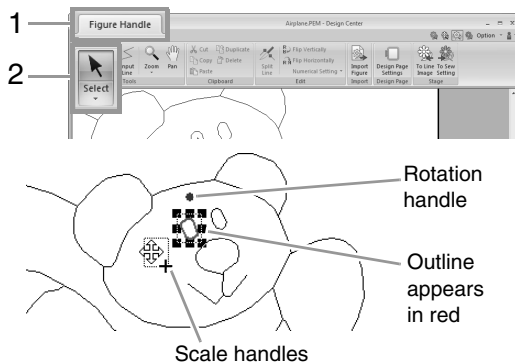

Memo:

Drag a handle to change the size or angle. To delete the outline, press the **Delete** key.

- 2 Move the pointer over the outline so that the shape of the pointer changes to , and then drag the outline.

■ Adding lines to the figure handle image

- 1 Click 1, then 2.



- Click the start point (1), and then click the next point (2).

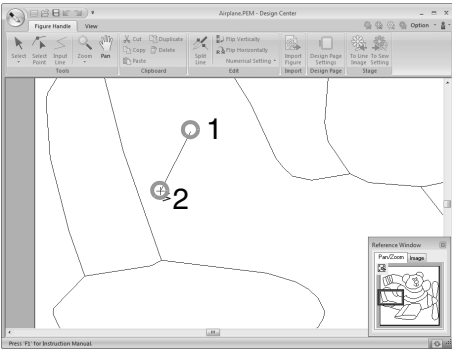

→ A line is drawn connecting the two points.
Continue clicking to draw additional lines.

Memo:

- To remove the last point that was entered, right-click.
- To draw vertical or horizontal lines, hold down the **(Shift)** key while moving the pointer.

- Double-click the end point.

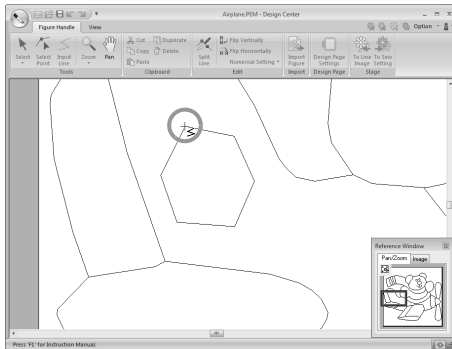

Memo:

Sewing attributes cannot be applied to regions if the region is not completely enclosed in an outline.

Reshaping outlines

- Click 1, then 2.

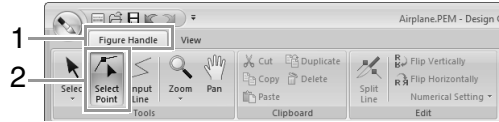

- Click an outline.

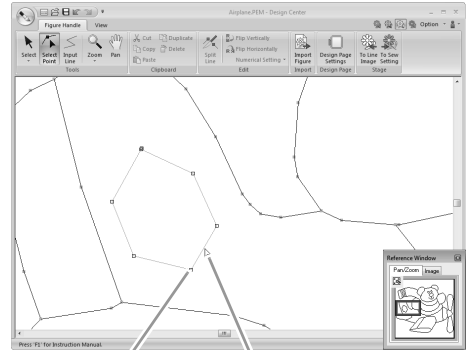

Point Line appears in pink

- To add a point, click the outline (1).
To create a corner, drag the point (2).

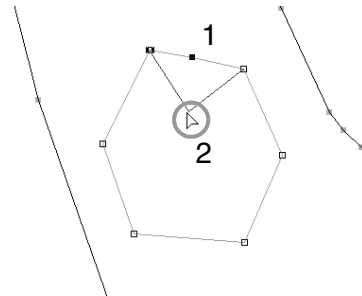

- If the point is deleted, the corner is removed. Click the point (1), and then press the **(Delete)** key, or click 2.

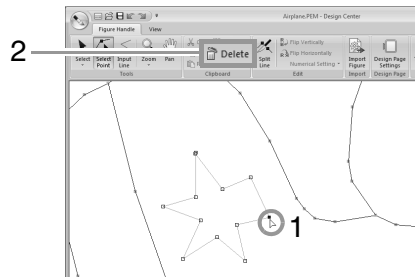

- To change the shape of the line, drag the point.

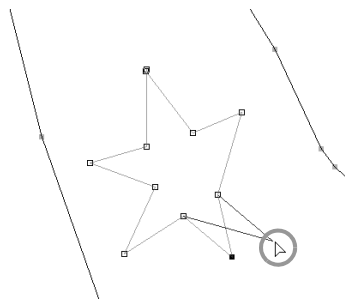

Memo:

- If multiple points are selected, all of the points will be moved or deleted.
- To select additional points, hold down the **Ctrl** key and click each point, or drag the pointer over the points.

Splitting lines

Lines can be split at a point.

- Perform steps 1 and 2 in “Reshaping outlines” to select a line.
- Select a point 1, and then click 2 to split the line.

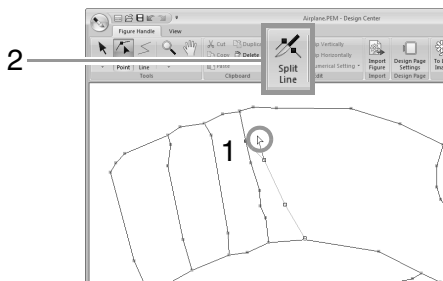

Connecting lines

Two points can be connected to form a line.

- Perform steps 1 and 2 in “Reshaping outlines” to select a line.

- While holding down the **Alt** key, drag the selected point to the other point that you want to connect to it.

→ The shape of the pointer changes to , and a red square appears when the two points are overlapping.

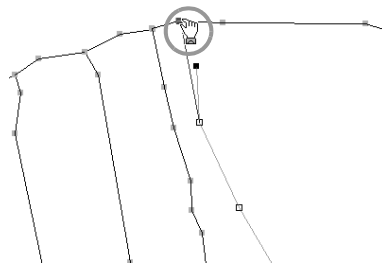

- Release the mouse button to connect the two points.

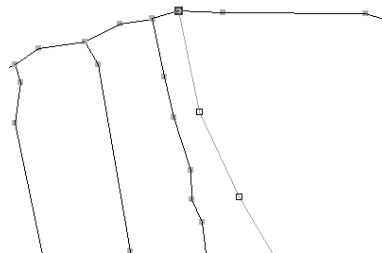

Continuing to the Sew Setting Stage

When the figure handle image is finished, continue to the Sew Setting Stage.

- Click 1 or 2.

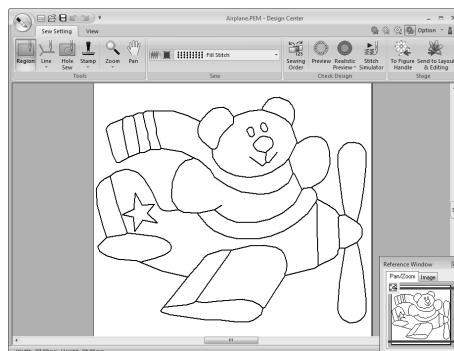
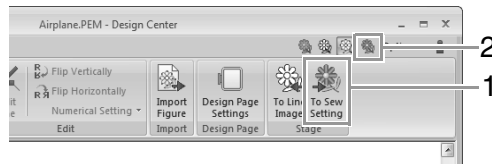



Memo:

Even after continuing to the Sew Setting Stage, you can return to the Figure Handle Stage to edit the figure handle image.

Step 4 Sew Setting Stage

We are now going to apply sewing attributes to the different parts of the outline to create the embroidery pattern.

Specifying sewing attributes

- 1 To specify the sew type for the line, click 1, then 2, then 3.

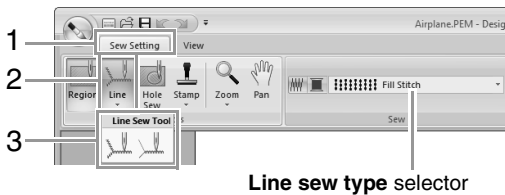

Line sew type selector



: Click this button to apply sewing attributes to the entire outline.



: Click this button to apply sewing attributes to a portion of the outline.

To specify the sew type for the region, click 1, then 2.



Region sew type selector

- 2 Click

- 3 Click the desired color.

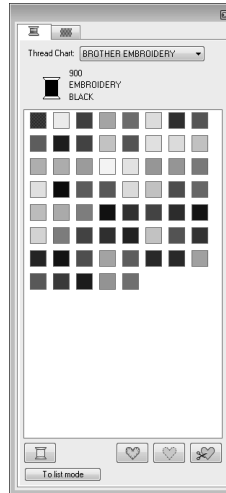

- 4 Click the down arrow in the **sew type** selector and choose the desired sew type.

- 5 When using or , click the outline where the sewing attributes are to be applied.

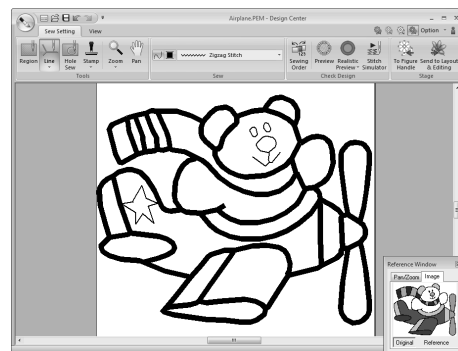

- 6 When using , click the region where the sewing attributes are to be applied.

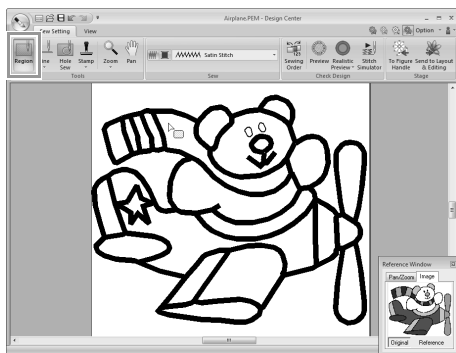

To change the sewing attributes, repeat steps

- 1 through 6.



Note:

Sewing attributes for region cannot be applied to open regions (regions not fully enclosed in an outline), as shown in the illustration below.

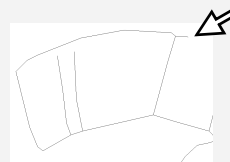

If attributes cannot be applied to a region, return to the Figure Handle Stage and make sure that region is closed. Edit any broken lines with the Edit Point tool.

 "Adding lines to the figure handle image" on page 187

 Memo:

- From the **Sewing Attribute Setting** dialog box, detailed settings for attributes, such as the width of satin stitches and the run pitch, can be specified.

 "Specifying sewing attributes" on page 205.

- The Reference Window is useful for specifying colors while checking the colors of the original image.

Using the Reference Window

This allows you to select colors while checking the colors in the original image.

1. Click **1**, then **2**. Select the **Reference Window** check box.

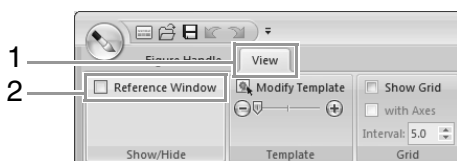

2. Click the **Image** tab.

→ The image opened in Original Image stage appears.



If **Reference** has been clicked, click **Original**.

Step 5 Importing into Layout & Editing

The embroidery pattern created in Design Center can be imported into Layout & Editing. In addition, the created data can be transferred to the machine using functions in Layout & Editing.

 Note:

If the sewing attributes of an outline or region are not set, the embroidery pattern cannot be imported.

- 1 Click **1**, then **2**.

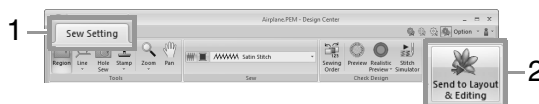

→ Layout & Editing starts up.

- 2 Specify settings for **Magnification** and **Orientation**, and then click **Import**.

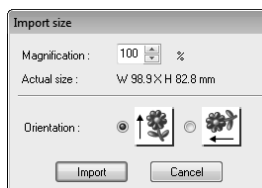

Design Center Window



- 1 **Application button**
- 2 **Ribbon**
- 3 **Quick Access Toolbar**
- 4 **Stage button**
Indicates the current stage. Click to move to a different stage.
- 5 **Option button**
- 6 **Help button**
- 7 **Reference Window** (👉 page 200)
Displays all outlines and patterns in the work area, giving you an overview while you work on a detailed area.
- 8 **Design Page**
- 9 **Work area**
- 10 **Status bar**
- 11 **Refresh Window button**

👉 "Understanding Windows" on page 19

Original Image Stage

Using the wizard

This wizard provides a step-by-step guide for creating embroidery patterns.

Click **1**, then **2**.

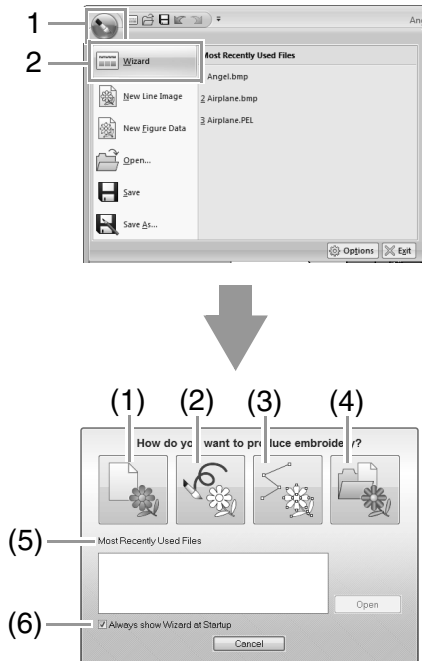

(1) From Image

Clicking this button displays the **From Image** dialog box.

(2) New Line Image

Clicking this button opens a new Design Page in the Line Image Stage.

 *"Drawing a new line image freehand" on page 197.*

(3) New Figure

Clicking this button opens a new Design Page in the Figure Handle Stage.

 *"Drawing a new figure handle image freehand" on page 199.*

(4) Open PEM

Clicking this button displays the **Open** dialog box so that a .pem file can be selected.

(5) Most Recently Used Files

From the list, click the name of the file, and then click **Open**.

(6) Always show Wizard at Startup

Select this check box to start up the wizard each time Design Center is started up.

Opening an image

When you click the **From Image** button in the **How do you want to produce embroidery?** dialog box, the **From Image** dialog box appears.

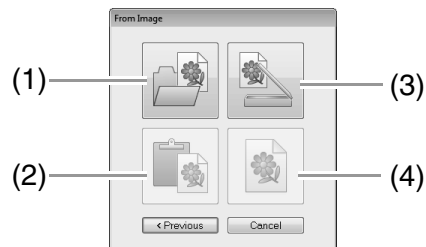

(1) Open Image File

Clicking this button that displays the **Open** dialog box to select an image file.

 *"Image file formats" on page 137*

(2) From Clipboard

Clicking this button to paste the image on the Clipboard into the Design Page. This function can only be used when there is an image on the Clipboard.

(3) From TWAIN Device

Clicking this button to import an image from a TWAIN device (such as a scanner) connected to your computer, then paste it in the Design Page.

(4) Use Current Image

Clicking this button to use an image opened in the Original Image Stage. This function can only be used when an image is opened in the Original Image Stage.

Memo:

- To import an image from a file TWAIN device
 - Connect the TWAIN device to the computer, and then click **Image**, then **Open from TWAIN Device**, or click **From TWAIN Device** in the **From Image** dialog box. When the **Select Source** dialog box appears, select a device. Next, click **Select**.
 - For information on using the driver interface, refer to the help manual for that interface, or contact the manufacturer of the interface.
- Tips for scanning illustrations for Design Center
 - If the outline is not clear, trace the outline on tracing paper.
 - Better scanning results may be produced by reducing the tone of the image.

Opening a file

1. Click 1, then 2.

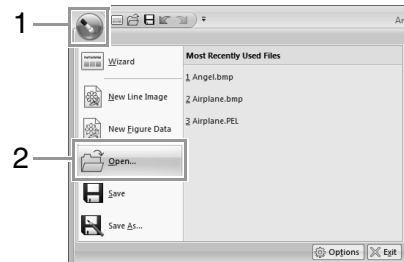

2. Select the drive and the folder.
3. To open a file, select it, and then click **Open**, or double-click the file's icon.

Memo:

- If an image file is selected, the file is opened in the Original Image Stage.
- If a .pel file is selected, the file is opened in the Line Image Stage.
- If a .pem file is selected, the file is opened in the Figure Handle Stage or the Sew Setting Stage.

Line Image Stage

Extracting the outlines of an image

1. In the Original Image Stage, click 1.



 "Original Image Stage" on page 185.

2. Selecting the colors to be used for the outlines, and then click **OK**.

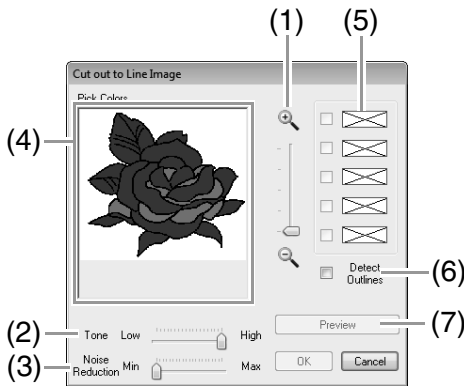

- (1) **Zoom** slider
Use this slider to adjust the zoom ratio for displaying the image.
- (2) **Tone** slider
Use this slider to reduce color tones in images where it is difficult to select the outline color.
- (3) **Noise Reduction** slider
Use this slider to reduce image noise (distortions) in images where the outline is not clear.
- (4) Click the outline color(s) to convert into black outlines.
- (5) Displays the colors selected in (4). To deselect a color, clear the corresponding check box.
- (6) To extract the color boundaries, click **Detect Outlines** check box.

Memo:

When the extracting color boundaries using **Detect Outlines**, the colors are converted to line image as shown below.

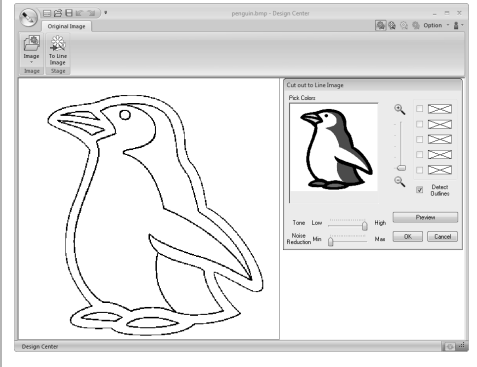

- (7) Click **Preview** to preview the line image in the Design Page.

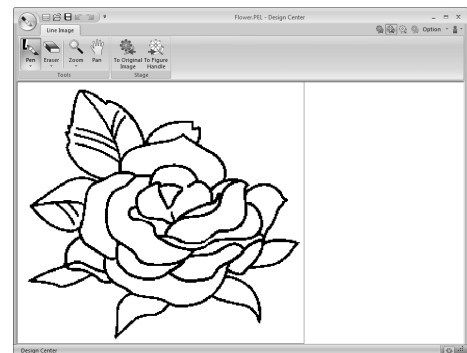

Drawing a new line image freehand

Click 1, then 2.



Using the Pen and Eraser tools, the line image can be drawn freehand in the Design Page.

 *"Line Image Stage" on page 186.*

Memo:

In the Line Image Stage, the file will be saved as a .pel file.

 *"Saving embroidery patterns" on page 210, and "Drawing a new figure handle image freehand" on page 199.*

Figure Handle Stage

Changing settings for converting to outlines

1. In the Line Image Stage, click 1.



“Line Image Stage” on page 186.

2. Specify the desired settings in the **Figure Object Conversion Setting** dialog box, and then click **OK**.

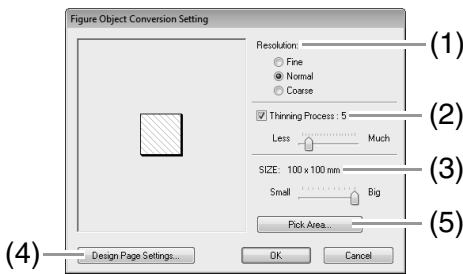

- (1) Select a setting under **Resolution**.
 - Fine:** Select this setting only if the image contains many small details.
 - Normal:** Select this setting to provide a sufficient resolution without making the file too large.
 - Coarse:** Select this setting to keep the file as small as possible.
- (2) To replace the black outlines with figure handle lines along the center of the outlines, select the **Thinning Process** check box, and then use the slider to select the degree of detail.

Memo:

When the slider is set to **Much**, even very thick black lines will be replaced with a line along the center.

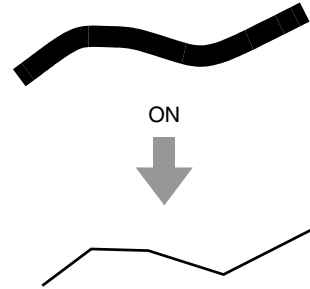

To replace the black lines with figure handle lines following the border of the outlines, clear the **Thinning Process** check box.

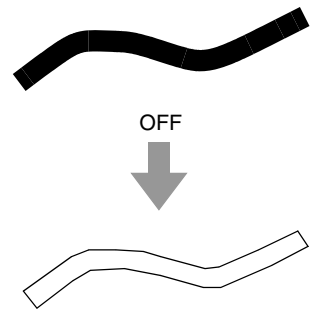

- (3) Use the **SIZE** slider to set the size.
- (4) You will not be able to enlarge the image beyond the limits of the Design Page area. If necessary, click **Design Page Property**, and then change the Design Page size.
- (5) To create outline data from a part of the image, select the specific area by clicking **Pick Area**, then dragging the pointer (+) to draw a selection frame around the area to be selected.

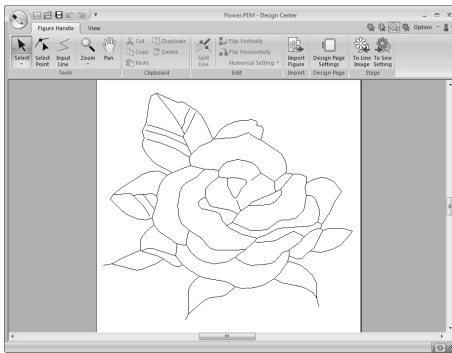

Note:

It may not be possible for outline data to be created from an image when moving from the Line Image Stage to the Figure Handle Stage, even after various outline conversion settings have been specified. If this occurs, return to the Line Image Stage, and correct the outlines in the line image or apply corrections to the image.

Drawing a new figure handle image freehand

Click 1, then 2.

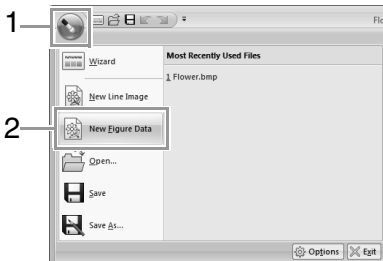

Memo:

- In the Figure Handle Stage, the file will be saved as a .pem file.
- To retrieve data from a saved .pem file, use the command **Import Figure** in the **Figure Handle** tab.

Specifying the Design Page size

1. Click 1, then 2.

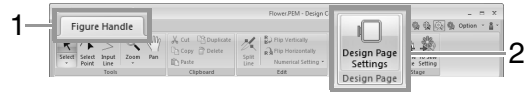

2. Select the Design Page size, and then click OK.

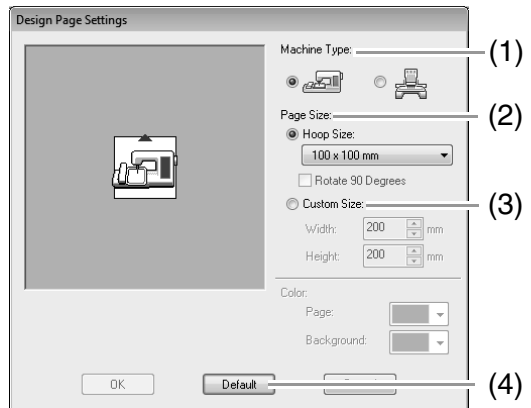

- (1) Select a machine type.
The settings available in the **Page Size** selector differ depending on the machine type selected here.
- (2) To adjust the Design Page size according to the hoop size, select **Hoop Size**, and then select the desired hoop size from the selector.
- (3) To specify a custom Design Page size, select **Custom Size**, and then type or select the desired width and height for the Design Page.
- (4) To return to the default settings, click **Default**.

Note:

- Do not select a hoop size larger than the embroidery hoop that can be used with your machine.
- Do not create a Custom Hoop larger than the embroidery hoop that can be used with your machine.

Editing outlines

Scaling outlines

Scaling numerically:

1. Select the outline.
2. Click 1, then 2, then 3.

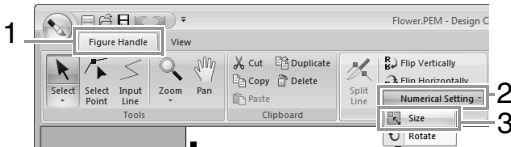

3. Select a size, and then click **OK**.

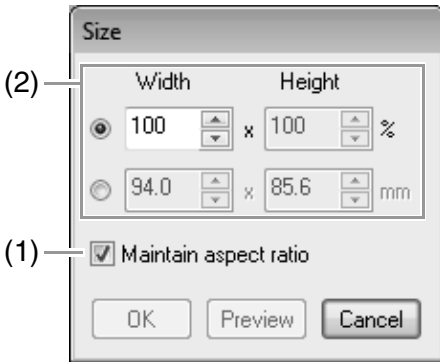

- (1) To change the width and height proportionally, select the **Maintain aspect ratio** check box.
- (2) Select whether the width and height will be set as a percentage (%) or a dimension (millimeters or inches). Type or select the desired width and height.

Flipping outlines horizontally or vertically

1. Select the outline.
2. Click 1, then 2.

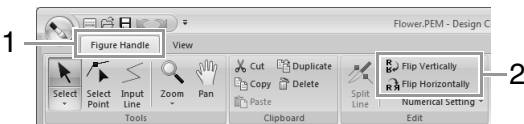

Rotating outlines

Rotating manually:

1. Select the outline.
2. Move the pointer over the rotation handle. And then drag.

Rotating numerically:

1. Select the outline.
2. Click 1, then 2, then 3.

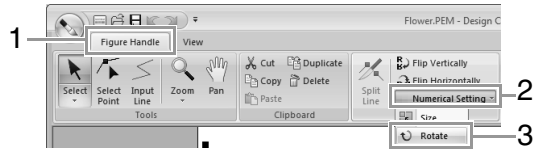

3. Type or select the desired rotation angle, and then click **OK**.

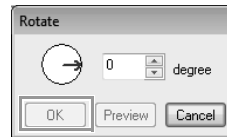

Memo:

An angle can also be selected by dragging  in the **Rotate** dialog box.

Viewing outlines in the Reference Window

Click 1, then 2.

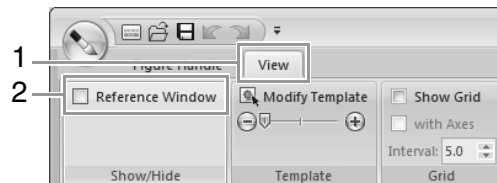

■ Zooming

The Reference Window can be switched to display either the entire Design Page or only the embroidery pattern.

Click the **Pan/Zoom** tab, click .

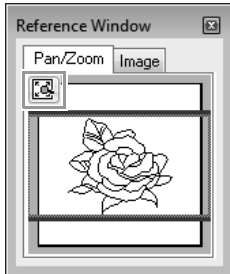

Displays the entire Design Page.

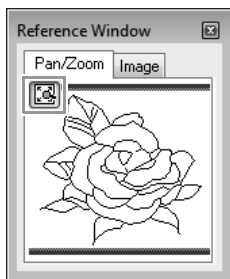

Displays the entire pattern.

■ Moving the display area frame

The part of the outline displayed in the Design Page can be selected from the Reference Window.

1. Move the pointer over the display area frame.
2. Drag the display area frame so that it surrounds the desired part of the outline.
 - The selected part of the outline is displayed in the Design Page.

■ Redrawing the display area frame

Instead of moving the display area frame, the frame can be redrawn to display the desired part of the outline in the Design Page.

Click the area to be displayed, or drag the pointer over the desired part of the outline in the Reference Window.

■ Displaying a different reference image

1. Click the **Image** tab.

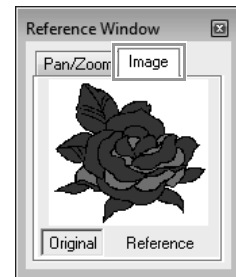

2. Click **Reference**, then click .

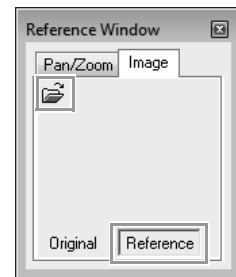

3. Select the reference image, and then click **Open**.

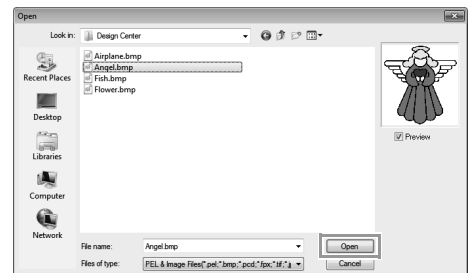

Changing the background image

Changing the display of the background image

Click **1**, and then drag the slider **2**, or click  or

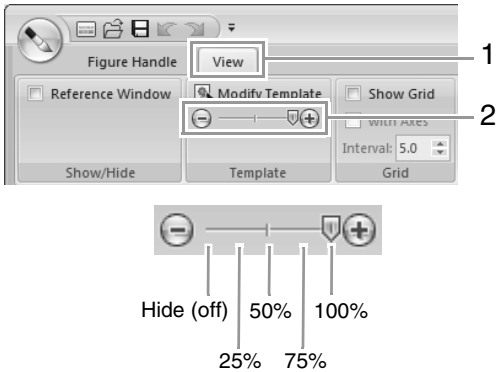

Changing the size and position of the background image

1. Select the template. Click **1**, then **2**.

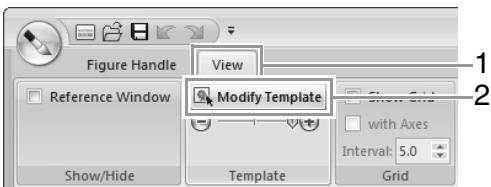

2. Drag the template image to move it to the desired location.
Drag a handle to enlarge or reduce the size of the template image.

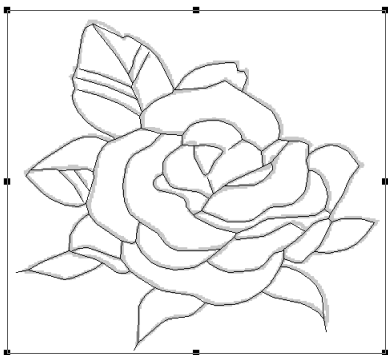

Changing application settings

Changing the grid settings

1. Click **1**.

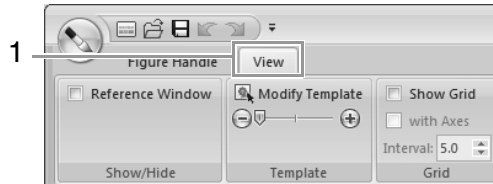

2. Specify the grid settings.

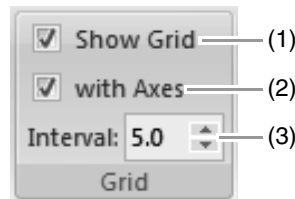

- (1) To display the grid, select the **Show Grid** check box.
To hide the grid, clear the **Show Grid** check box.
- (2) To display the grid as solid lines, select the **with Axes** check box.
To display the grid as dots (intersecting points of the grid), clear the **with Axes** check box.
- (3) To set the grid spacing, type or select a value in the **Interval** box.

Changing the measurement units

Click **Option**, then **Options**, then **System Unit**, and then select the desired measurement units (**mm** or **inch**).

 "System unit" on page 22

Sew Setting Stage

In the Figure Handle Stage, click 1.

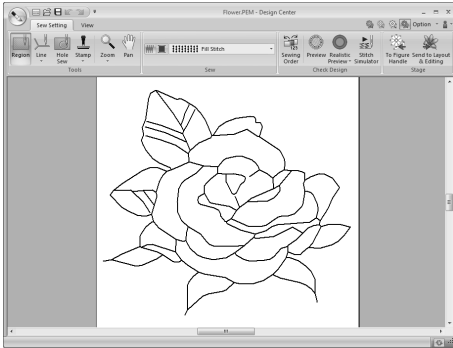
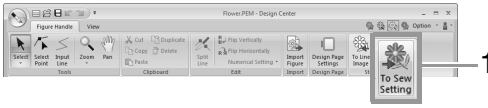

Memo:

In the Sew Setting Stage, the colors of the Design Page and background can be changed from the **Design Setting** dialog box (displayed by clicking 1, then 2).

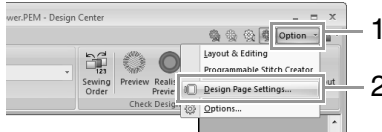

Setting region/line sewing

Region sewing

1. Click 1, then 2.

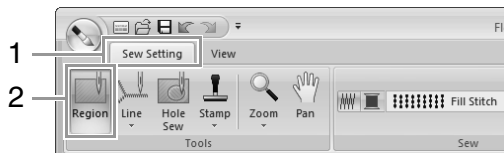

2. If necessary, change the color and sew type.

 "Sewing attributes" on page 204

3. Click the enclosed region to apply the sewing attributes.

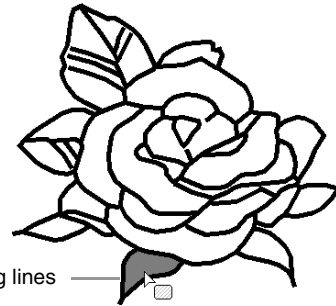
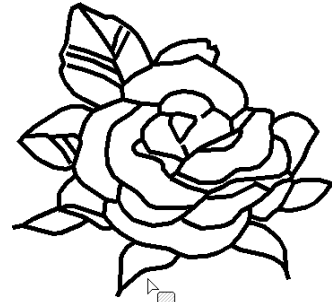

Marching lines

Note:

- If the attributes cannot be applied to a region, go back to the Figure Handle Stage and make sure that region is closed.
- Edit any broken lines with the Edit Point tool.

 **Memo:**

- Although a region may seem closed, if the sewing attributes cannot be specified for the region, the region may not actually be closed.
- To find the opening in the region, use the line drawing mode in the Figure Handle Stage to divide the region into smaller regions, and then check which region sewing attributes cannot be applied to in the Sew Setting Stage.

■ **Line sewing**

1. Click 1, then 2, click 3.

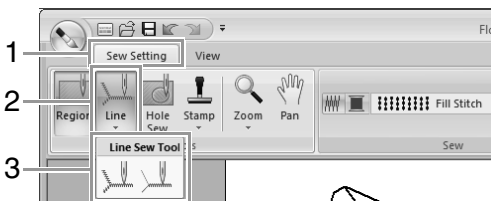

2. If necessary, change the color and sew type.

 “Sewing attributes” on page 204.

3. Click the outline to apply the sewing attributes.

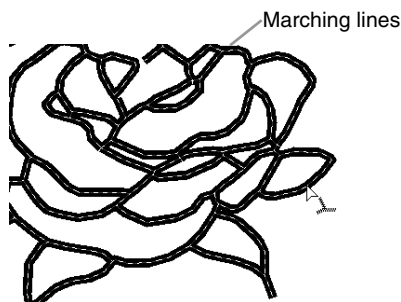
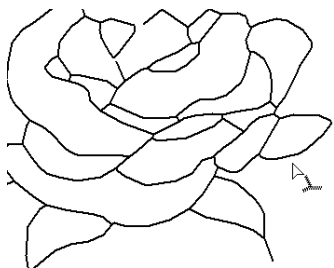

 **Memo:**

When  is selected, settings are applied only to a portion of the clicked outline.

Sewing attributes

The Sew pane on the **Sew setting** tab, available in the Sew Setting Stage, allows you to set the color and sew type of region and outlines.



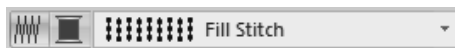

The sewing attributes that are available depend on the tool selected.

Example 1: When  is selected

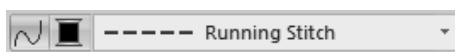



Example 2: When  or  is selected



 Region sew	Switches on/off sewing for the region.
 Line sew	Switches on/off sewing for the line.
 Region color, Line color	Click this button to set the thread color for lines or regions.
 Region sew type	Use these selectors to set the sew type for lines or regions.
 Line sew type	

■ Region sew / Line sew

 switches on/off region sewing;  switches on/off line sewing.

1. Clicking the button switches between the two settings.

On: The **Region color/Line color** button and the **Region sew type/Line sew type** selector are displayed.

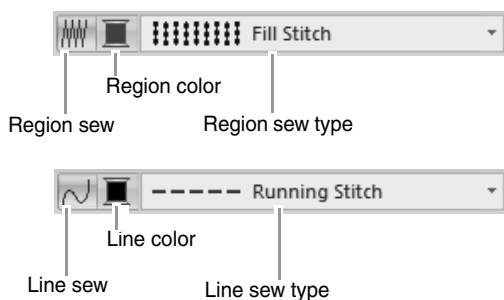

2. Click the region or outline where the sewing attributes are to be applied.

Memo:

If region sewing or line sewing has been switched on, the regions or lines appear in the selected thread color. If it has been switched off, the regions appear in white or the outlines appear as dotted lines.

■ Color

1. Click the **Color** button.
2. From the **Thread Chart** selector, select a thread color chart or a user thread chart.

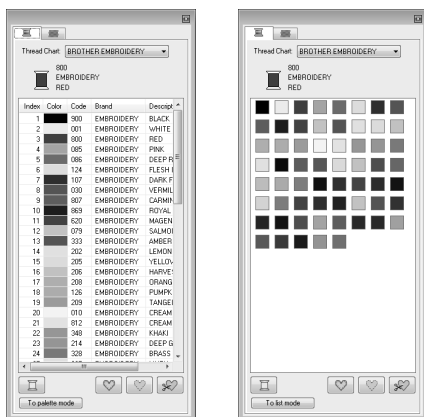

3. From the list of thread colors, click the desired color.

 For details on the four buttons under the list, refer to "Special colors" on page 57

4. Click the region or outline to apply the color setting.

■ Sew type

1. Click in a sew type selector.
2. Click the desired sew type.

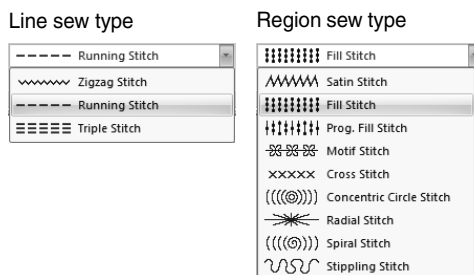

3. Click the region or outline to apply the sew type setting.

■ Specifying sewing attributes

To display the **Sewing Attributes** dialog box, click 1, then 2.

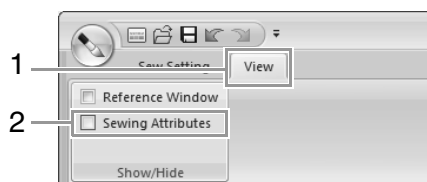

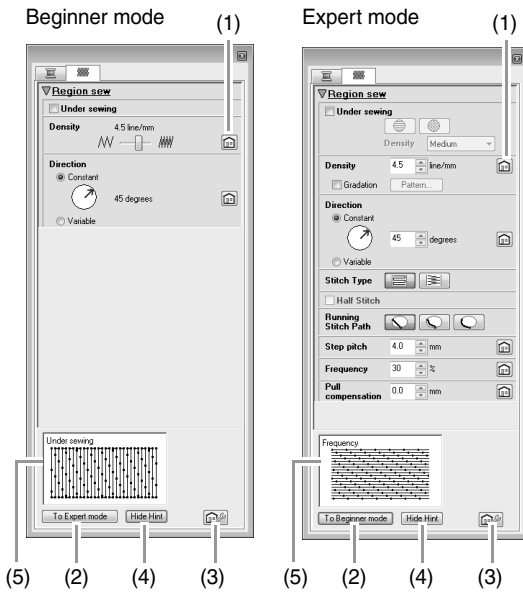

• For region sewing

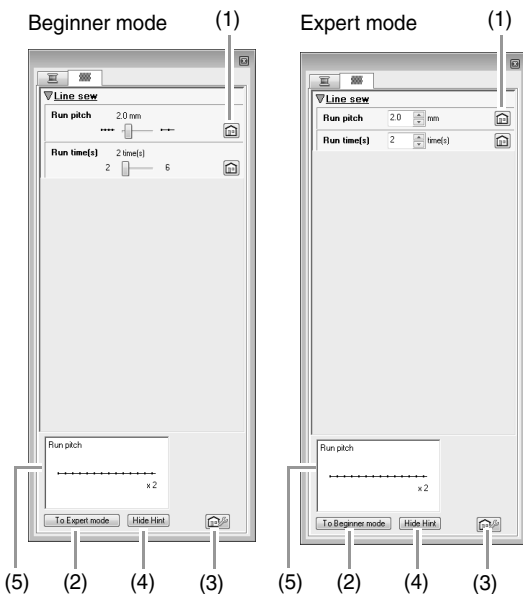

• For line sewing



- (1)  : Click to return to the default setting.
- (2) To Expert mode/To Beginner mode: Click to switch the mode.
- (3)  : Click to load/save the sewing settings.

 "Saving frequently used sewing attributes" on page 170

- (4) Hide Hint/Show Hint: Click to switch between displaying and hiding the hint view
- (5) With each change in the sewing attributes, a preview of the stitching can be checked here.

1. Change the sewing attributes displayed under **Line sew** or **Region sew**.

 For details on the different sewing attributes and settings, refer to "Line sewing attributes" on page 296 and "Region sewing attributes" on page 301

2. When the line sewing attributes are displayed, click an outline to apply the line sewing attributes to the outline.

When the region sewing attributes are displayed, click a region to apply the region sewing attributes to the region.

Memo:

Saving frequently used sewing attributes

- Frequently used sewing attributes can be saved together, and recalled when specifying sewing attributes.
- Perform this operation in the same way that it is performed in Layout & Editing.

 For details, refer to "Saving frequently used sewing attributes" on page 170

■ Creating a gradation

The density of the color can be adjusted at various locations to create a custom gradation pattern.

1. In Expert mode of the **Sewing Attribute Setting** dialog box, select the **Gradation** check box, and then click **Pattern**.



- Specify the desired settings in the **Gradation Pattern Setting** dialog box, and then click **OK**.

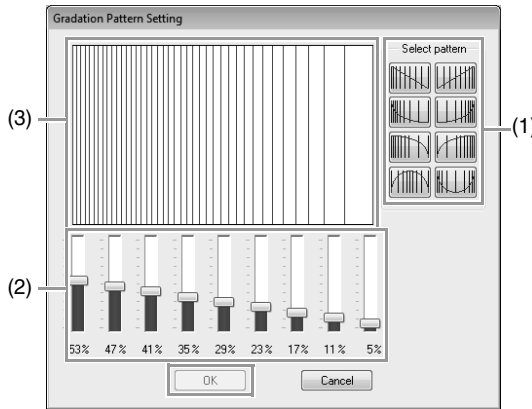

- To select a preset gradation pattern, click the desired pattern under **Select pattern**.
- Move the sliders to adjust the density of the gradation pattern.
- The preview area shows the setting changes that you make.

Memo:

Gradation can be specified if satin stitches, fill stitches or programmable fill stitches have been selected for the region sewing and **Constant** has been selected as the sewing direction.

Note:

An additional color (used for blending in Layout & Editing) cannot be specified with the gradation setting in Design Center.

Applying effects to concentric circle and radial stitches

In order to increase the decorative effect, you can move the center point of regions set to the concentric circle stitch or radial stitch.

- Click **1**, then **2**.

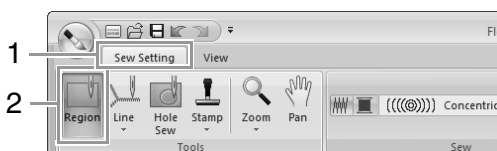

- Select the desired color and sew type (**Concentric Circle Stitch** or **Radial Stitch**).

- Click the region.
→ The center point (■) appears.
- Drag the center point to the desired location.

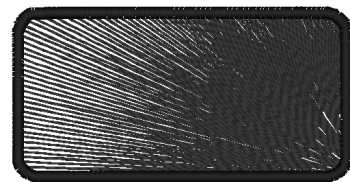
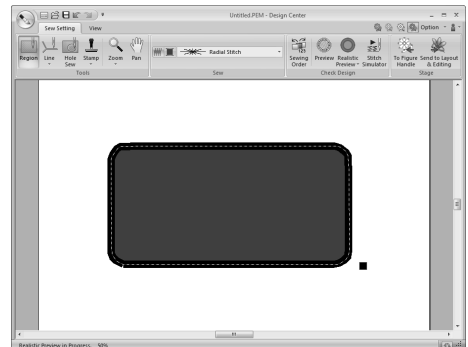
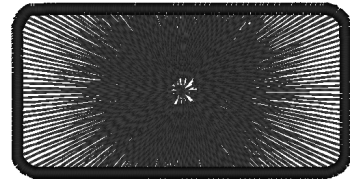
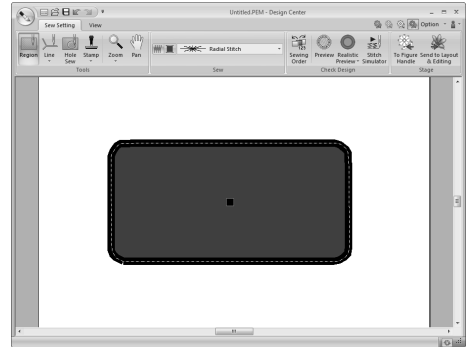

Memo:

To move the center point later, click , and then right click the region with the concentric circle stitch or radial stitch applied. The center point appears and can be moved.

Preventing overlapping stitching of regions (hole sewing)

By specifying hole sewing, the stitching in overlapping regions will not be sewn twice. Hole sewing can be set only when one region completely encloses another.

1. Click 1, then 2.

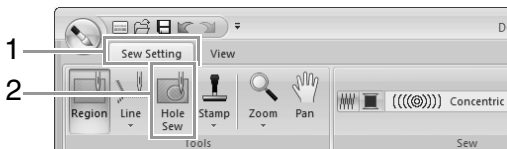

2. Click the region that completely encloses another region.



3. Click **OK** to set hole sewing.

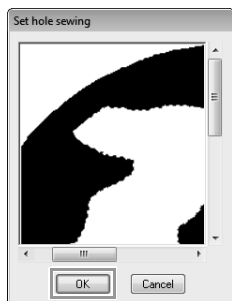

Memo:

To cancel hole sewing, click the white inner region. The inner region will be sewn twice when it appears in the same color as the outer region.

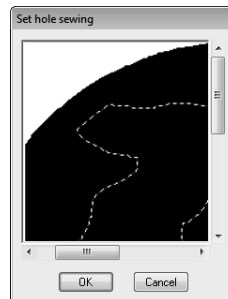

Applying stamps

Stamps can be applied to regions in the Sew Setting Stage of Design Center.

- Click 1, then 2, click 3.

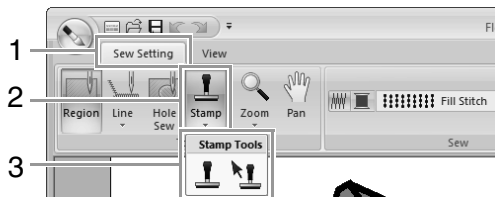

 : Click this button to apply a stamp.

 : Click this button to edit the applied stamp.

Settings for stamps are specified in the same way that they are in Layout & Editing.

 “Applying and editing stamps” on page 60

Memo:

Some stamp patterns are provided with this application; however, by using Programmable Stitch Creator, you can edit the patterns that are provided or you can create your own.

Checking and editing the sewing order

1. Click 1, then 2.

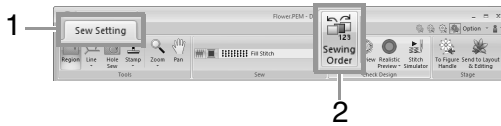

2. To change the sewing order of a color, select the frame for the color, and then drag the frame to the desired position.

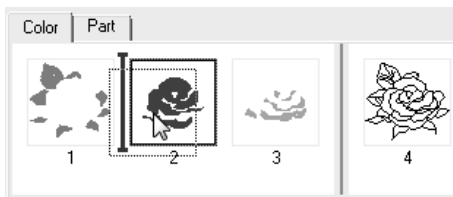

Memo:

- To select additional frames, hold down the **Shift** or **Ctrl** key and select each frame.
- The frames containing regions are separated from the frames containing outlines with a thick vertical line. Frames from one side of the line cannot be moved to the other side.
- To enlarge the pattern for better viewing, click .

3. To view the sewing order of multiple patterns of the same color, select the frame, and then click the **Part** tab.



4. To change the sewing order of a pattern, select the frame for the pattern, and then drag the frame to the desired position.
5. Click **OK**.

Checking the stitching in the Stitch Simulator

To view stitching using the stitch simulator, click 1, then 2.

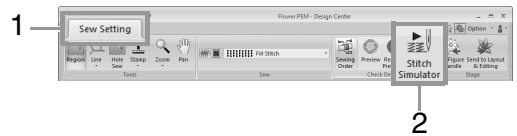

The basic operations are the same as those described for Layout & Editing.

 "Checking the stitching with the Stitch Simulator" on page 71

Viewing embroidery patterns in the Reference Window

Embroidery patterns can be viewed in the Reference Window in the Sew Setting Stage in the same way that they are in the Figure Handle Stage.

 "Viewing outlines in the Reference Window" on page 200.

Saving embroidery patterns

The file can be saved at each stage.

Overwriting

Click 1, then 2.

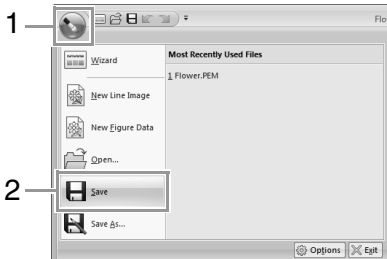

Saving with a new name

1. Click 1, then 2.

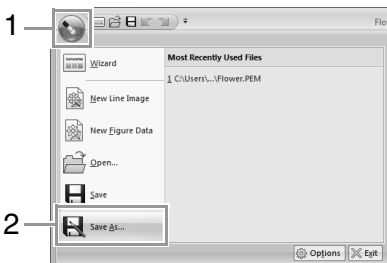

2. Select the drive and the folder, and then type in the file name.

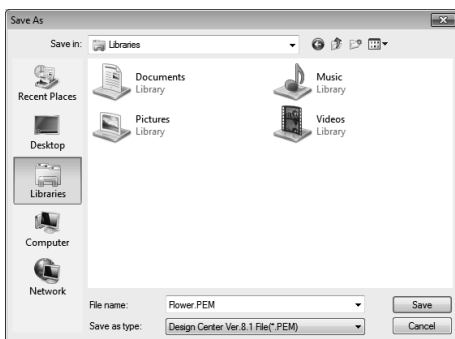

3. Click **Save**.

Memo:

- Image data from the Original Image Stage can be saved as a bitmap file (.bmp).
- In the Line Image Stage, image data is saved as a .pel file.
- In the Figure Handle Stage and the Sew Setting Stage, pattern data is saved as a .pem file.

Note:

If you select a file type of a previous software version, saved .pem files can be opened with that version of the software; however, some information may be lost.

Design Database

Using Design Database, the created embroidery data can be managed. In addition, while viewing images of the file contents, the files can be organized, or multiple embroidery designs can be transferred to embroidery machines.

Design Database Window

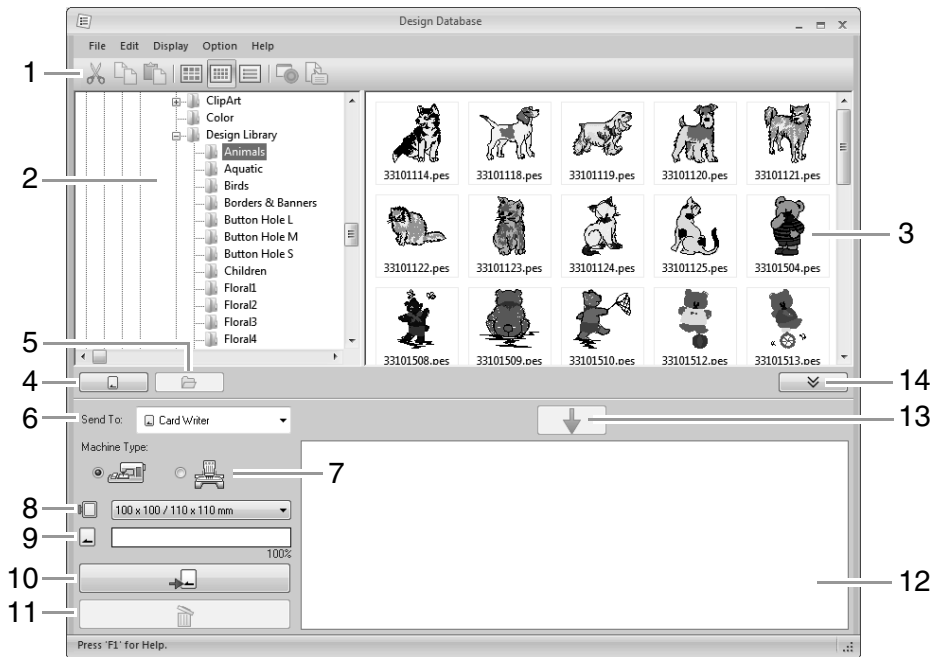

1 Toolbar

2 Folder pane

3 Contents pane

Displays thumbnails of all embroidery design in the selected folder.

4 Card reading button

Reads an original card.

5 Folder content display button

Displays the folder contents.

6 Send to selector

Select where the embroidery files will be written or sent.

7 Machine Type

The settings available in the hoop size selector differ depending on the selected machine type.

8 Hoop size selector

9 Card Capacity indicator

Displays the capacity of the original card or embroidery machine memory for the selected designs (displayed in the writing list) when an original card or embroidery machine has been selected as the destination for writing the data.

10 Write button

Begins writing the selected designs (displayed in the writing list).

11 Remove button

Returns the selected design (displayed in the writing list) to the unselected state.

12 Writing list

Displays the list of designs to be written to the original card, USB media or embroidery machine.

13 Add button

Adds the design selected in the contents pane to the writing/transfer list.

14 Writing box display/non-display button

Click when writing/transferring designs. Click this button to hide or display the Writing list.

Memo:

Settings for the following can be selected from the **Option** menu.

- Select **mm** or **inch** as the system units.
- Select **Blue**, **Black**, **Silver** or **Aqua** as the application color.

Starting Up Design Database

1. Click , then select **All Programs**, then **PE-DESIGN NEXT**, then **Tools**, then **Design Database**.
2. Click a folder in the folder pane.
 - All embroidery files in the folder are displayed in the contents pane on the right.

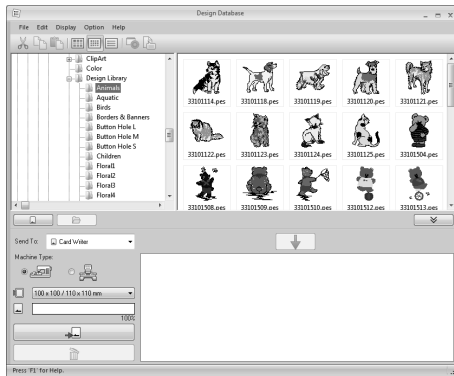

Memo:

- The displayed files have the following extensions.
.pes, .phc, .dst, .exp, .pcs, .hus, .vip, .shv, .jef, .sew, .csd, .xxx, .pen
- .pem files are not displayed since they cannot be read by the machine. Import the embroidery design into *Layout & Editing from Design Center*, and then save it as a .pes file.
- Zipped file can not be read in this application.

 "Importing into Layout & Editing" on page 192.

Organizing Embroidery Designs

Creating new folders

1. In the folder pane, on the left, select the folder.
2. Click **File**, then **Create New Folder**.

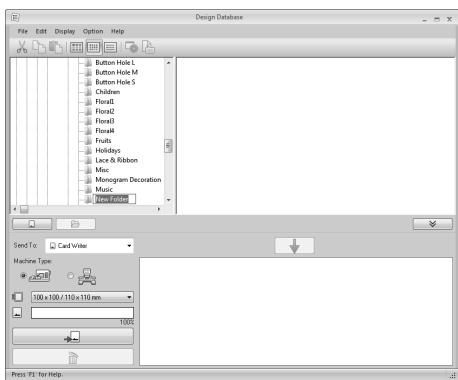

3. Type in the name of the new folder, and then press the **Enter** key.

Moving/copying files to a different folder

1. In the folder pane, locate the folder where you want to move the embroidery design.
2. In the folder pane, click the folder that contains the embroidery design.
3. Drag the embroidery design in the contents pane to the folder you previously located in the folder pane.

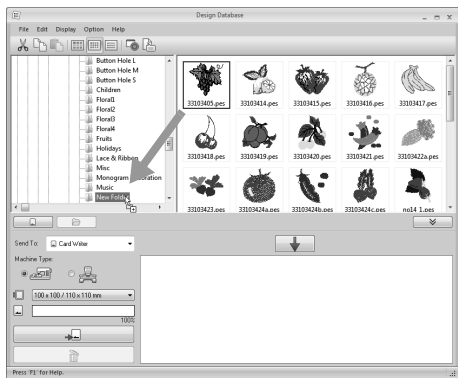

→ If the two folders are on the same drive, the selected embroidery design is **moved** to the other folder.

→ If the two folders are on separate drives, the selected embroidery design is **copied** into the other folder.

Memo:

- To copy the file from one folder to another on the same drive, hold down the **Ctrl** key while dragging the embroidery design.
- To move the file from one folder to another on different drives, hold down the **Shift** key while dragging the embroidery design.
- The file can also be removed from the current folder (or copied) by selecting the menu command **Edit - Cut** (or **Edit - Copy**). Then, the file can be added to the new folder by selecting it in the folder pane, then selecting the menu command **Edit - Paste**.

Changing file names

Note:

The names of embroidery designs can be changed from Design Database only when the sewing information (menu command **Display - Details**) is displayed.

☞ "Changing how files are displayed" on page 215.

1. In the folder pane, select the folder containing the embroidery design.
2. Select the embroidery design. Then click again.

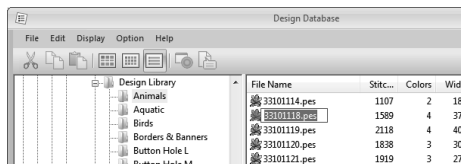

3. Type in the new name of the embroidery design, and then press the **Enter** key.

Memo:

When renaming a file, the file extension cannot be changed.

Deleting files

1. In the folder pane, select the folder containing the embroidery design that you want to delete.
2. In the contents pane, select the name of the embroidery design.
3. Press the **Delete** key.
→ The file is moved to the Recycle Bin.

Changing how files are displayed

The embroidery designs in the contents pane can be displayed as large thumbnails or small thumbnails, or they can be listed by their sewing information.

Large Thumbnails

Click  or click **Display**, then **Large Thumbnails**.

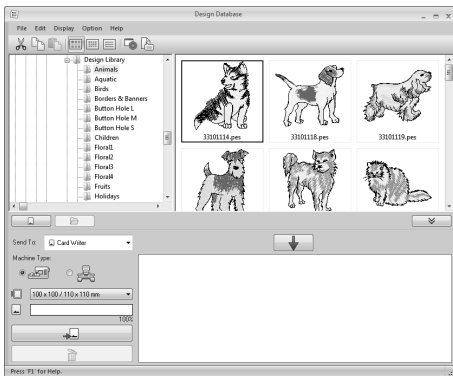

Small Thumbnails

Click  or click **Display**, then **Small Thumbnails**.



Sewing information

Click  or click **Display**, then **Details**.

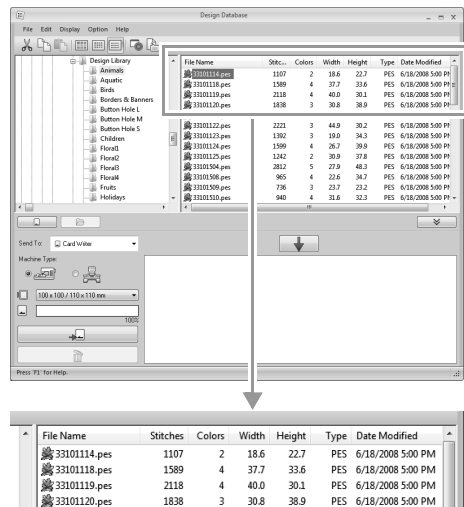

Opening Embroidery Designs

Opening files with Layout & Editing

1. In the folder pane, select the folder containing the embroidery design that you want to open in Layout & Editing.



Note:

Be sure to select a folder that contains .pes files.

2. In the contents pane, select the .pes file.
3. Click **File**, then **Open in Layout & Editing**.

Importing files into Layout & Editing

Files in the following formats can be imported.
.pes, .phc, .dst, .exp, .pcs, .hus, .vip, .shv, .jef, .sew, .csd, or .xxx

1. In the folder pane, select the folder containing the embroidery design that you want to import into Layout & Editing.
2. In the contents pane, select the embroidery design.
3. Click **File**, then **Import Into Layout & Editing**.
→ The selected embroidery design appears in the Layout & Editing window.



Note:

Files in the .pen format cannot be imported into Layout & Editing.

Transferring Embroidery Designs to Machines

Note:

The procedures for transferring the created embroidery design to an embroidery machine differ depending on your embroidery machine model. For detail, refer to the Operation Manual provided with your embroidery machine.

Transferring to a machine by using an original card/USB media/USB cable

1. Prepare the media to be used to make the transfer, or connect an embroidery machine to the computer.

Note:

Be sure that the hoop size of the design does not exceed the hoop that will be used on the embroidering machine.

Memo:

- If the design is to be written to an original card, insert the original card into the USB card writer module.
- If the design is to be written to USB media, plug the USB media into the computer.
- If the design is to be transferred directly to an embroidery machine, connect the embroidery machine to the computer. For details on transferring design, refer to the Operation Manual provided with your embroidery machine.
- In order to use the Link function to transfer embroidery designs, an embroidery machine compatible with the Link function must be running in Link mode.

 "Using the Link Function to Embroider From the Computer" on page 177

2. Click .

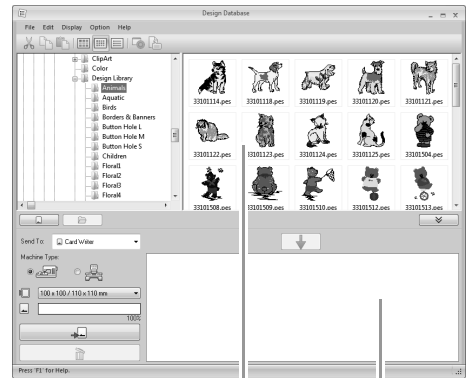
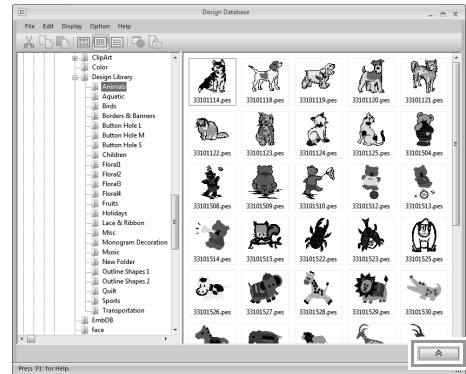

Contents pane
(Available designs)

Writing list
(Selected designs)

3. Click the **Send To** selector, and then click the destination.

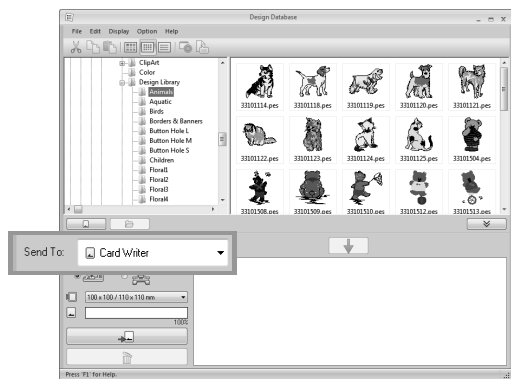

- (1) Sends designs to the USB card writer.
- (2) Sends designs to embroidery machine(s) by using the Link function.

Memo:

If **Link** is not available in the **Send To** selector, check that the embroidery machine is running in Link mode and that the cable is correctly connected.

 "Using the Link Function to Embroider From the Computer" on page 177

- (3) Sends designs to the USB media.
- (4) Sends designs directly to an embroidery machine.

The remaining steps differ depending on the destination where the data is to be sent.

■ Using an original card

Designs can be transferred to an embroidery machine equipped with a card slot.



 **Note:**
Files other than .phc files can be written.

- 4. Select  from the **Send To** selector.
- 5. Under **Machine Type**, select the type of embroidery machine to be used.

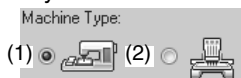

- (1) Single-needle machine
- (2) Multi-needle machine

- 6. From the **Hoop size** selector, select the appropriate size of embroidery hoop.

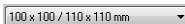

 **Note:**

- Do not select a hoop size larger than the embroidery hoop that can be used with your embroidery machine. Otherwise, the created original card will not work correctly with the embroidery machine.
- When writing to an original card that already contains data, all data on the card will be deleted. Before writing to a card, save all necessary data to a hard disk or other media, and check that no necessary data remains on the card.

 "From an embroidery card" on page 79

- 7. Click .
- 8. Select a folder in **1**, select an embroidery file from the contents pane **(2)**, and then click **3** to add the file to the writing list. After all embroidery files to be written are added to the writing list, click **4**.

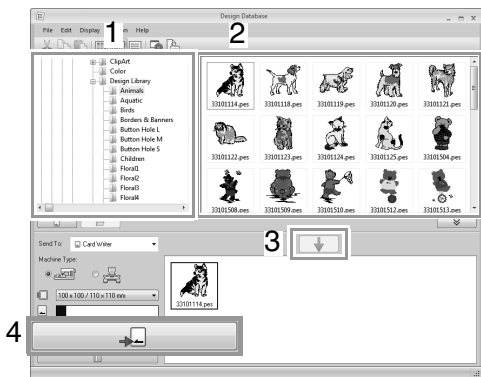

Note:

- An embroidery design for the jumbo frame cannot be transferred to the machine by using an original card.
- If the pattern in the selected embroidery file is larger than the hoop size selected in step 6, or the number of stitches or number of colors for the pattern exceeds the maximum for the hoop selected in step 6, that file cannot be added to the writing list. Only the embroidery designs displayed in the writing list will be written to the original card.

Memo:

- Embroidery files can also be added to the writing list by right-clicking the file, then clicking **Add to Writing List**, or by selecting a file in the contents pane and dragging it to the writing list.
- A file can also be removed from the writing list by right-clicking it in the writing list, then clicking **Remove from Writing List**.

9. If the files are to be written to an original card, the following message appears. Click **OK**.

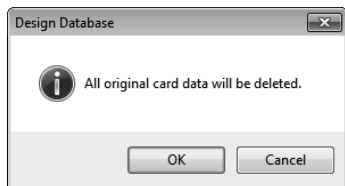

Note:

Do not remove the card or unplug the USB cable while designs are being written to the card (while the LED indicator is flashing).

10. When a message appears, indicating that writing is finished, click **OK**.

Memo:

Patterns created on a custom-sized Design Page are written to cards split into their various hoop sections.

Note of "Transferring to a machine by using an original card" on page 174

- To rewrite the embroidery files written on the original card, click to select those files, and move files to the writing list in the same manner.

- To check the embroidery design file being written to the original card, click



→ **Card** appears in the folder pane, and all embroidery designs written to the original card appear in the contents pane.

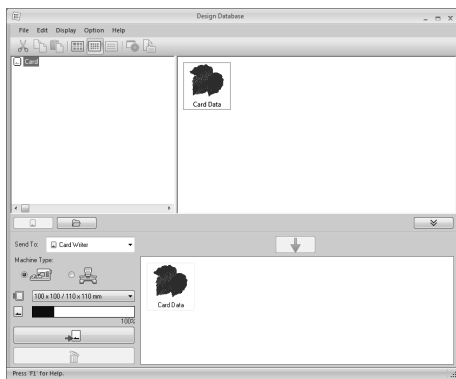

Memo:

- Embroidery designs written to the original card appear as "Card Data" in the contents pane.

- To display the contents of the folder in the contents pane, click . Switch the display by clicking and



■ Using USB media

Designs can be transferred to an embroidery machine compatible with the USB Host function.



4. Select  from the **Send To** selector.

Memo:

If multiple USB media are connected,  for each connected device appears. Select the USB media where the design is to be written.

5. Click .

6. Select a folder in **1**, select an embroidery file from the contents pane (**2**), and then click **3** to add the file to the writing list. After all embroidery files to be written are added to the writing list, click **4**.



→ The designs in the writing list are written to the USB media.

→ When the designs have been written, the message “Finished outputting data” appears.

Memo:

If a volume label has been specified for the USB media, “ [(Drive Letter):] (Volume Label)” appears in the **Send To** selector.

If a volume label has not been specified,

“ [(Drive Letter):] USB Media” appears.

For details on changing the name (volume label) for the USB media, refer to the manual provided with the USB media.

Note:

- Do not remove the USB media while designs are being written.
- If there is already a file with the same name at the destination, the following dialog box appears. Select whether to overwrite the existing file, to stop copying or to copy the file using a different name.



Transferring directly to a machine's memory

Designs can be transferred to embroidery machines that can be connected to a computer using a USB cable.

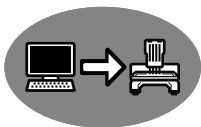

4. Select  from the **Send To** selector.

Memo:

If multiple embroidery machines are connected,  for each machine appears. Select the machine to be used to embroider.

5. Click .

6. Select a folder in **1**, select an embroidery file from the contents pane (**2**), and then click **3** to add the file to the writing list. After all embroidery files to be written are added to the writing list, click **4**.



- The designs in the writing list are written to the embroidery machine's memory.
- When the designs have been written, the message "Finished outputting data" appears.

Note:



- Do not remove the USB cable while designs are being written.
- If there is already a file with the same name at the destination, a dialog box appears. Select whether to overwrite the existing file, to stop copying or to copy the file using a different name.

Sending embroidery designs to machines by using the Link function

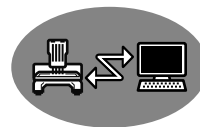
An embroidery machine compatible with the Link function must be running in Link mode.



 "Using the Link Function to Embroider From the Computer" on page 177

4. Select  from the **Send To** selector.
5. Click .
6. Select a folder in **1**, select an embroidery file from the contents pane (**2**), and then click **3**.

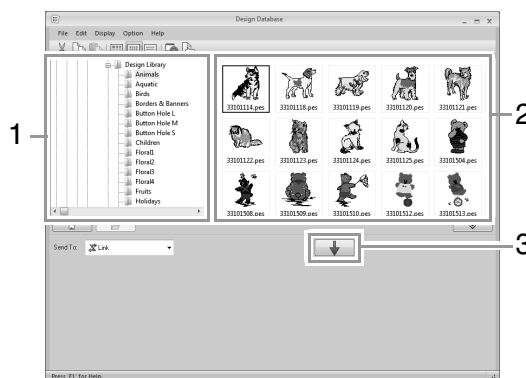

7. Continue the procedure as described in Step 5 of "Using the Link Function to Embroider From the Computer" on page 178.

Note:

Files in the *.dst*, *.exp* and *.phc* formats cannot be transferred with the Link function. When **Link** is selected in the **Send To** box, *.dst*, *.exp* and *.phc* files do not appear in the contents pane. In addition, embroidery files with the Design Page size set to **Custom Size** or with **Hoop Size** set to **360 × 360 mm (Jumbo Frame)** do not appear in the contents pane.

Memo:

To display the **Link** dialog box again after the computer has been restarted, click **Link** in the **Option** menu.

Searching for an Embroidery Design

1. In the folder pane, select the folder.
2. Click **File**, then **Search**.
3. Specify the search conditions. Select the check box of the search conditions to be specified.

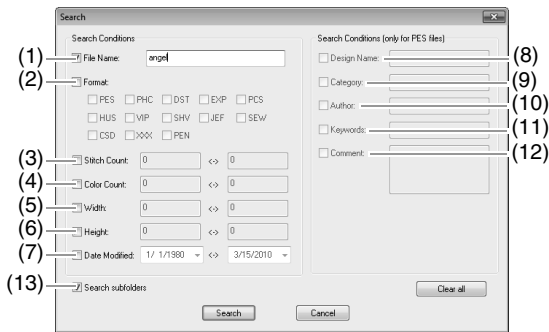

- (1) **File Name**
Select to search for files with a specific file name. Type the file name in the box.



Memo:

Wildcard characters (“?” to represent a single character and “*” to represent multiple characters) can also be used.

- (2) **Format**
Select the check box beside the desired file format.
- (3) **Stitch Count**
In the boxes, type the lower and upper limits of the range for the number of stitches.
- (4) **Color Count**
In the boxes, type the lower and upper limits of the range for the number of thread colors.
- (5) **Width**
In the boxes, type the lower and upper limits of the width range.
- (6) **Height**
In the boxes, type the lower and upper limits of the height range.
- (7) **Date Modified**
In the boxes, type the modification date range (from when to when).

When searching for .pes files, the following conditions can also be specified.

- (8) **Design Name**
Type the design name in the box.
- (9) **Category**
In the box, type specific characters or the embroidery category.
- (10) **Author**
In the box, type the author’s name to be searched for.
- (11) **Keywords**
In the box, type the keyword to be searched for.
- (12) **Comment**
In the box, type the comment to be searched for.



Memo:

- To also search through the subfolders (folders within the selected folder), select the **Search subfolders** (13) check box.
- All characters entered in the box beside **File Name** will be considered as a single set of characters. However, you can search for files matching multiple words in the boxes below **Search Conditions (only for PES files)** by separating the words with a space.

4. Click **Search**.
→ A list of files matching the specified search conditions appears.

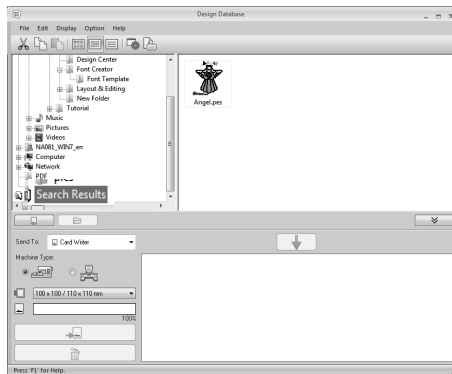

Converting Embroidery Design Files to Different Formats

Embroidery design files can easily be converted to a file of one of the other formats (.pes, .dst, .exp, .pcs, .hus, .vip, .shv, .jef, .sew, .csd, or .xxx).

1. In the folder pane, select the folder containing the embroidery design that you want to convert.
2. In the contents pane, select the embroidery design file.
3. Click **File**, then **Convert Format**.
4. From the **Format Type** selector, select the format that.

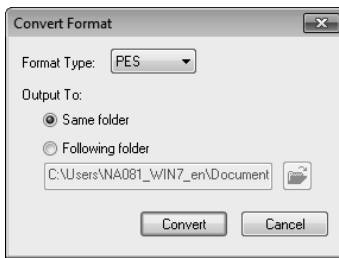

5. Under **Output To:**, select whether the new file is added to the same folder as the original file (**Same folder**) or to a specified folder (**Following folder**).

 **Memo:**

To change the folder where the new file will be added, click .

6. Click **Convert**.

→ The file is converted, and the new file is added to the specified folder.

 **Memo:**

- With **DST Settings** on the **Option** menu, the number of jumps for thread trimming can be specified for .dst files.

 “Specifying the number of jumps in embroidery design of the DST format” on page 274

- If multiple files with different formats are selected to be converted while Same folder is selected, any file with the same format as the new one will not be converted. However, if the files are being added to a different folder than the original one, any file with the same format as the new one will be copied to the different folder, instead of being converted.
- If the file is converted to a .pes file, the thread colors are converted as if the file was imported into Layout & Editing.

 **Note:**

Files cannot be converted to the .phc or .pen formats.

Checking Embroidery Designs

Previewing files

Toolbar button: 

1. Select a folder in **1**, select an embroidery file from the contents pane (**2**).

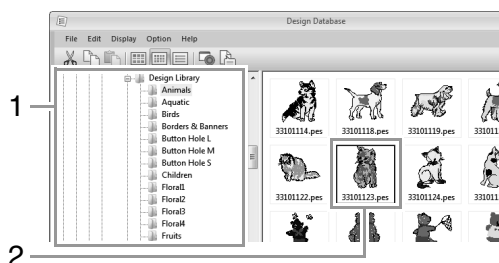

2. Click , or click **Display** menu, then **Preview**.



 **Memo:**

Files in the .pen format cannot be previewed.

Checking file information

Sewing information such as the file name, size, stitch count, sewing time, color count and modification date can be checked in the Property dialog box. With .pes file, additional information about the embroidery design can be viewed.

 **Note:**

- The displayed sewing time is an estimate. The actual sewing time depends on the machine model used and the specified settings.
- The sewing time is not displayed with .pen files.

Toolbar button: 

1. In the contents pane, select the embroidery design corresponding to the information that you want to view.
2. Click , or click **Display** menu, then **Property**.

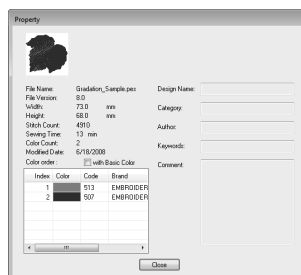

PES files (version 4.0 or later)

 Memo:

- Non-PES files and PES files (version 3.0 or earlier)

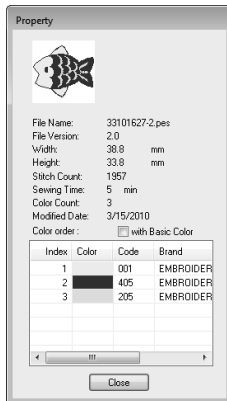

- If the Design Page size was set to **Custom Size** or if **Hoop Size** was set to a multi-position hoop (100 × 172 mm or 130 × 300 mm) or a jumbo frame (360 × 360 mm), a **Property** dialog box similar to the one shown below appears.

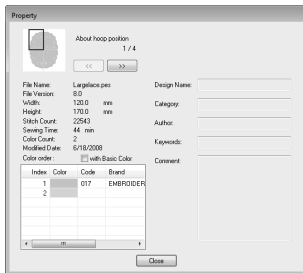

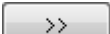
- The red box in the dialog box shows the position of the displayed pattern section.
- To display information for other hoop positions, click  or  .

Outputting a Catalog of Embroidery Designs

Printing

Images of all embroidery designs in the selected folder can be printed as a catalog or as an instruction guide.

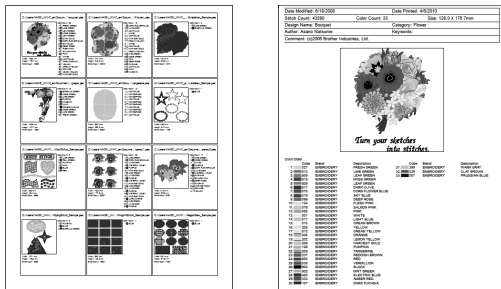

1. In the folder pane, select the folder containing the embroidery designs.
2. Click **File**, then **Print Setup**.
3. Under **Paper** (1) and **Orientation** (2), select the appropriate settings.

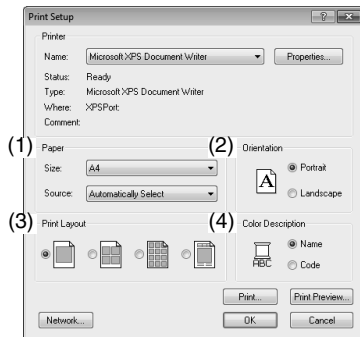

4. Select **Print Layout** (3).

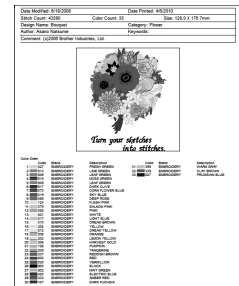
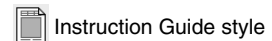
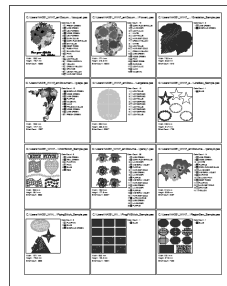
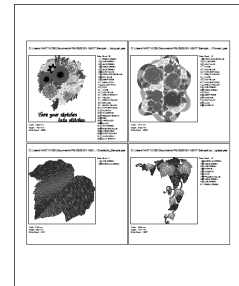
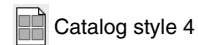
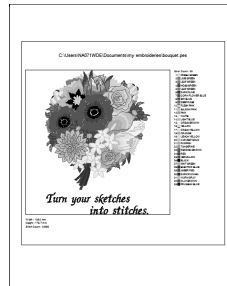
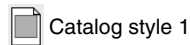

5. Under **Color Description** (4), select whether the thread colors appear as the name of the color or as the brand and thread number.
6. Click **Print**.

Memo:

- If one or more embroidery designs were selected in the contents pane, only the selected designs are printed.
- If the brand name, thread number or file properties is too long, some of the text may not be printed.
- If **File**, then **Print** is clicked, the embroidery designs are printed according to the settings already selected in the **Print Setup** dialog box.

Outputting as an HTML file

Instead of being printed, the catalog of embroidery designs can be outputted as an HTML file.

1. In the folder pane, select the folder containing the embroidery designs.
2. Click **File**, then **Create HTML**.
3. Select the drive and the folder, and then type in the name of the HTML file.

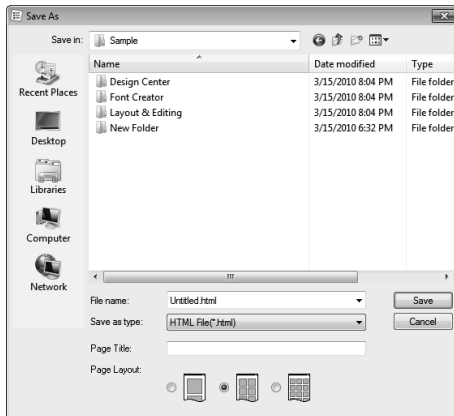

4. To add a title at the top of the file and in the title bar, type the title in the **Page Title** box.
5. Under **Page Layout**, select how the designs appear on the page.
6. Click **Save**.

Outputting as a CSV file

A .csv file containing the sewing information (file name, dimensions, number of stitches, number of colors, file path, file properties (.pes files only) and the names of thread colors and thread numbers) for selected embroidery designs can be outputted.

1. In the folder pane, select the folder containing the embroidery designs.
2. Click **File**, then **Create CSV**.
3. Select the drive and the folder, and then type in the name of the .csv file.

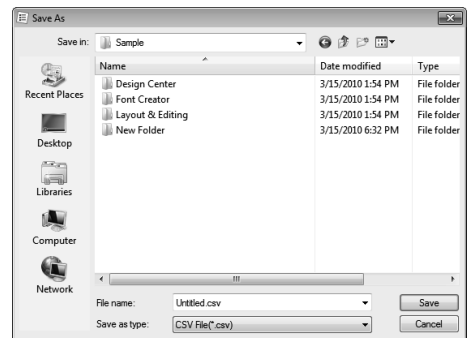

4. Click **Save**.

Programmable Stitch Creator

Programmable Stitch Creator allows you to create and edit stitch patterns, which can then be used as programmable fill stitches or motif stitches in both Layout & Editing and Design Center.

Basic Programmable Stitch Creator Operations

Programmable Stitch Creator is an application for creating, editing and saving stitch patterns that can be used for programmable fill stitch or motif stitch sewing. The following two types of patterns can be created in their corresponding mode.

Fill/stamp stitch patterns

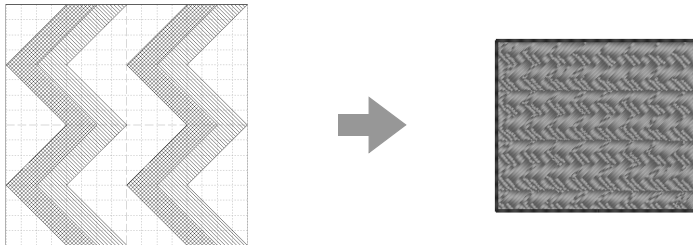

- These patterns can be used as stamp patterns and for sewing with the programmable fill stitch in Layout & Editing or Design Center.
- These patterns can be created with a single line or with multiple lines. In addition, these patterns can be used to create an embossing/engraving effect in sewn regions.
- These patterns are created in Fill/Stamp mode.

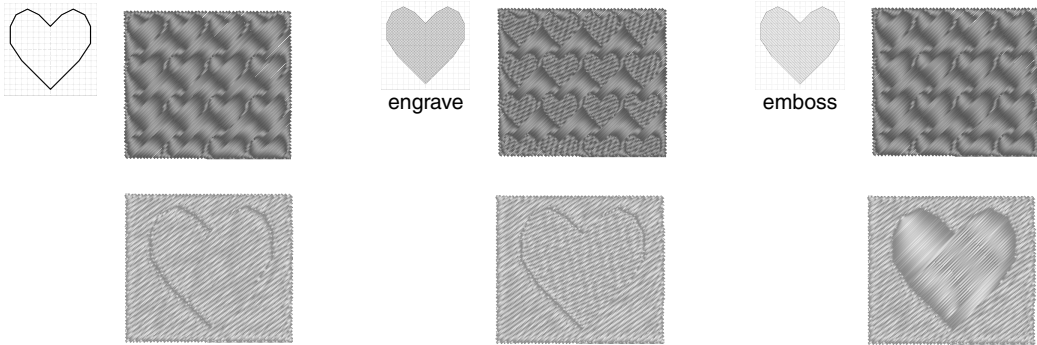

Motif stitch patterns

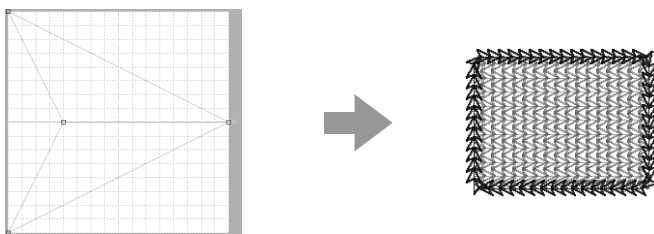

- These patterns can be used for sewing lines with the motif stitch and for sewing regions with the motif stitch, piping stitch and stippling stitch in Layout & Editing or Design Center.
- These patterns are created with a single line, which gives the look of a single-stroke drawing, and they are used for decorative machine sewing.
- These patterns are created in Motif mode.

Creating Fill/Stamp Stitch Pattern

Existing programmable stitch patterns can be edited to create new patterns.

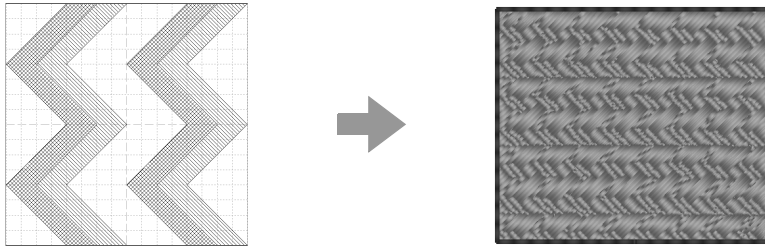

Step 1	Opening a fill/stamp stitch pattern
Step 2	Drawing lines to edit the fill/stamp stitch pattern
Step 3	Applying embossing/engraving effects to the fill/stamp stitch pattern
Step 4	Saving the edited fill/stamp stitch pattern
Step 5	Using the edited fill/stamp stitch patterns in Layout & Editing

Step 1 Opening a fill/stamp stitch pattern

First, we will open a fill/stamp stitch pattern to be edited. In this example, we will use pattern **wave1.pas**.

- 1 Click (Start), then select **All Programs**, then **PE-DESIGN NEXT**, then **Tools**, then **Programmable Stitch Creator**.

- 2 Click **1**, then **2**.

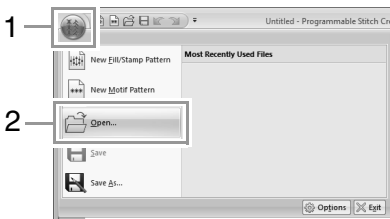

- 3 Select **Fill/Stamp File(*.PAS)** in the Files of type selector. Select the pattern file **wave1.pas**.

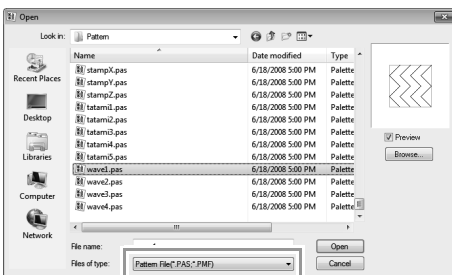

The pattern file can be found at the following location.

For example, (Drive where PE-DESIGN was installed)**Program Files (Program Files (x86))\Brother\PE-DESIGN NEXT\Pattern**.

Memo:

To view the data in the selected folder as thumbnails in the **Browse** dialog box, click **Browse**.

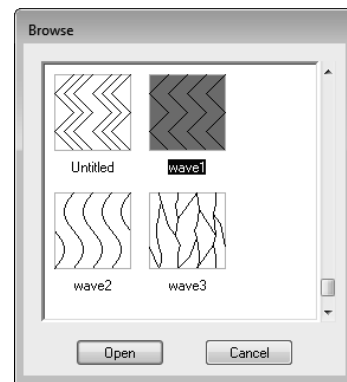

Step 2 Drawing lines to edit the fill/stamp stitch pattern

- 1 Click **1**, then **2**.

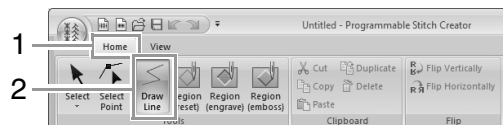

2 Click points 1 through 4.

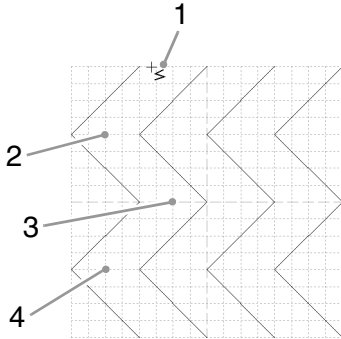

Memo:

- To remove the last point that was entered, click the right mouse button.
- "Reshaping a fill/stamp stitch patterns" on page 235
- The grid width can be changed.
- "Changing the grid settings" on page 244

3 Double-click 5 (end point).

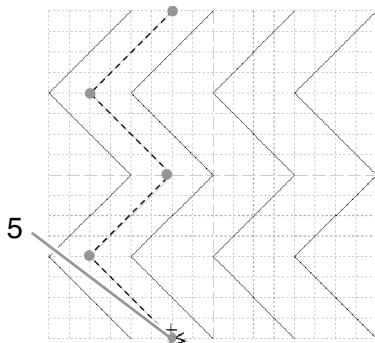

4 Repeat the previous operations.

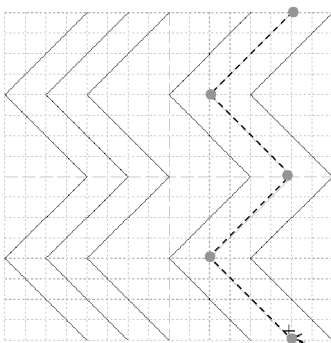

Step 3 Applying embossing/engraving effects to the fill/stamp stitch pattern

1 Click 1, and then double-click 2. Next, click 3, and then double-click 4.

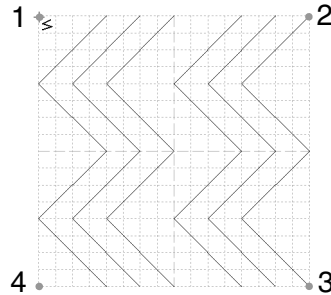

→ Lines are drawn along the top and bottom edges of the Design Page.

Memo:

In order to create an effect, the lines must form a closed region.

2 Click 1, then 2, and then click the first and fourth wave regions.

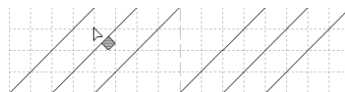
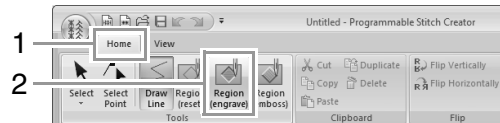

→ These regions appear in red and will be sewn with short stitches to give the effect of engraving.

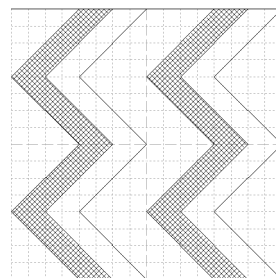

- Click 1, and then click the second and fifth wave regions.

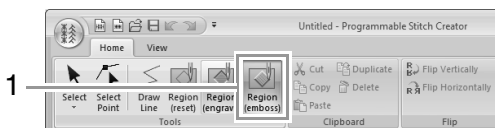

→ This region appears in blue and will be sewn with no dropped stitches to give the effect of embossing.

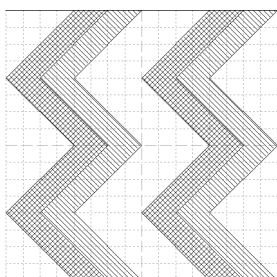

Memo:

To remove the embossing/engraving effect, use the **Region (reset)** tool. Click 1, then 2, and then click a region with an effect applied.

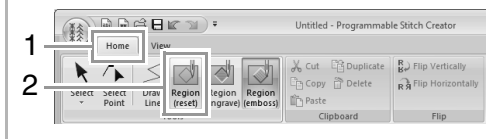

Step 4 Saving the edited fill/stamp stitch pattern

Fill/stamp stitch patterns are saved in the .pas format.

- Click 1, then 2.

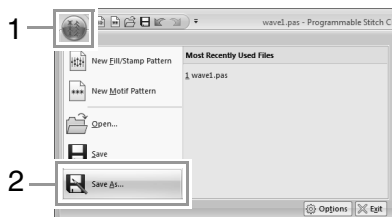

- Select the drive and the folder, and then type in the file name.

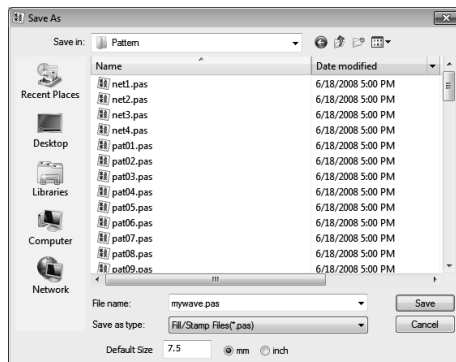

When saving a fill/stamp pattern, specify the size beside **Default Size**. Click **mm** or **inch** to select the measurement units.

- Click **Save**.

Step 5 Using the edited fill/stamp stitch patterns in Layout & Editing

- Start up Layout & Editing.
- Select an embroidery pattern.
- From the **Region sew type** selector (in the **Attributes** tab), select **Prog. Fill Stitch**.
- Display the **Sewing Attributes** tab.
 - “Specifying sewing attributes” on page 58
- Click  below **Programmable fill** in the **Region sew** section.

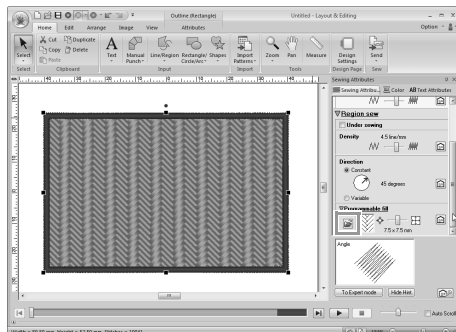

- 6 Select the drive and folder where the pattern was saved in Step 4.

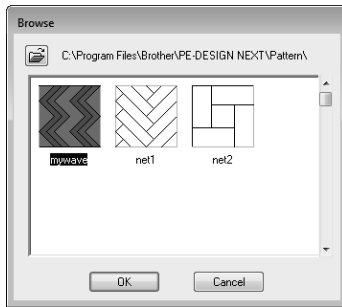

- 7 Click the edited fill/stamp stitch pattern, and then click **OK**.

→ The pattern is applied to the inside regions of the embroidery pattern.

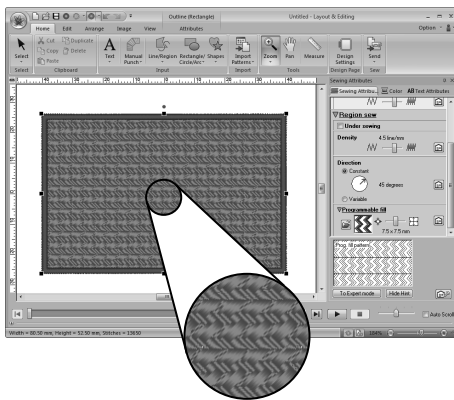

Memo:

- A fill/stamp stitch pattern can also be applied as a stamp by using the Stamp Tools.

 "Applying and editing stamps" on page 60

- For best results, refer to "Notes on programmable fill stitches and stamps" on page 305.

Editing a Pattern in Fill/Stamp Mode

■ Selecting patterns

1. To use the Select tool, click **1**, then **2**.



2. Click the pattern.

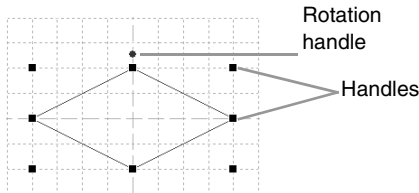

3. To select an additional pattern, hold down the **Ctrl** key and click the other pattern.

Memo:

- You can also select patterns by dragging the pointer across the pattern.
- Hold down the **Ctrl** key and click a selected pattern to deselect it.

■ Moving patterns

Selected patterns can be dragged to move them.

Memo:

- To move the pattern horizontally or vertically, hold down the **Shift** key while dragging it.
- Pressing the arrow keys moves the selected pattern one grid mark in the direction of the arrow on the key.

■ Scaling patterns

Drag a handle of the selected pattern to adjust its size. Drag the rotation handle to rotate the pattern.

Memo:

- If the **Shift** key is held down while a handle is dragged, the pattern is enlarged or reduced from the center of the pattern.
- To flip the selected pattern(s) up/down, or to flip the selected pattern(s) left/right, click **1**, then **2**.

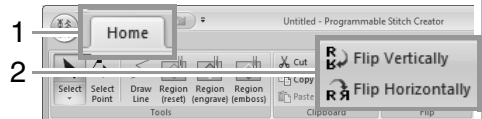

- Using commands other than those mentioned above, selected patterns can be edited in other ways, for example, duplicated or deleted.

"Menus/Tools" of "Programmable Stitch Creator" on page 289.

■ Reshaping a fill/stamp stitch patterns

1. Click **1**, then **2**.

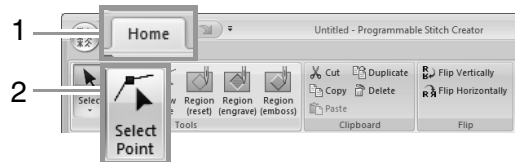

2. Click the broken line.

3. To edit a point, click the point to select it.

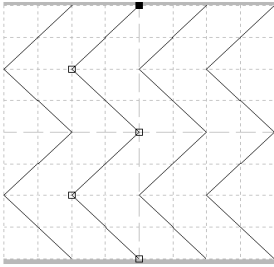



■: Selected point
□: Unselected point

- To move the point, drag it to the new location.
- To insert a point, click the line to add a new point.
→ A new point appears selected.
- To delete the point, click  **Delete** or press the **Delete** key.



Memo:

- If a line is composed of two points and you delete one of them, the entire line is deleted.
- To select multiple points, hold down the **Ctrl** key while clicking the points, or dragging the pointer over the points.
- Hold down the **Ctrl** key while pressing the  key or  key. The selection direction changes to the end or start point.
- Hold down the **Shift** key while dragging the points. The points are moved horizontally or vertically.
- Press an arrow key. The points move in the direction of the arrow on the key.

Creating Motif Stitch Pattern

Now, we will create a new motif stitch pattern. Motif stitch patterns are created in Motif mode.

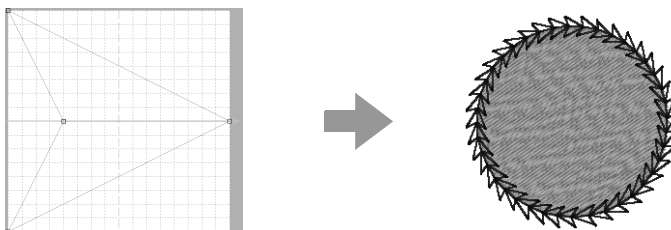

Step 1	Enter motif mode
Step 2	Shaping a single line to create motif stitch pattern
Step 3	Saving the created motif stitch pattern
Step 4	Using the edited motif stitch pattern in Layout & Editing

Step 1 Enter motif mode

- 1 Start up Programmable Stitch Creator.
- 2 Click 1, then 2.

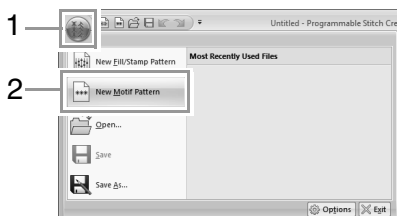

Step 2 Shaping a single line to create motif stitch pattern

In **Motif mode**, you can create original patterns by changing the shape of a single line.

- 1 Click 1, then 2.

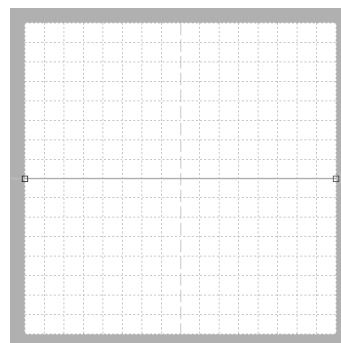
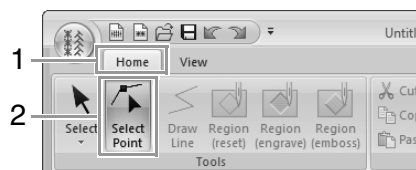

Blue square: Start point
Red square: End point

- 2 Select 0, then drag the point. The line that moves turns green when moving a point.

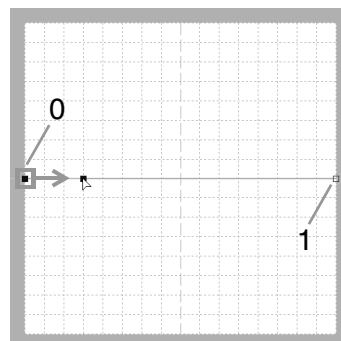

- 3 Click the line to insert points.
Click **2** located between 0 and 1.
Click **3** located between 2 and 1.

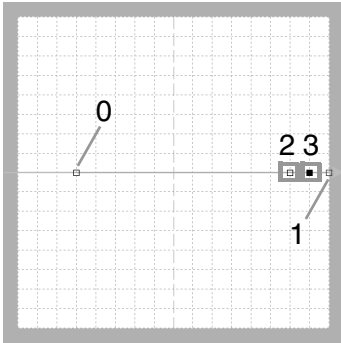

- 4 Select **3**, then drag the point.

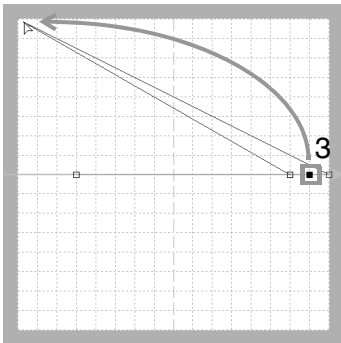

- 5 Click between 1 and 3 to insert point **4**, and then drag point **4**.

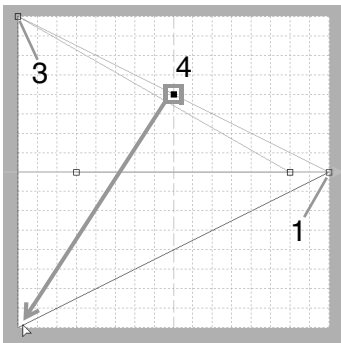

- 6 Click **5** located between 3 and 4, then drag the point to 0.
Select **2**, then drag the point to 1.

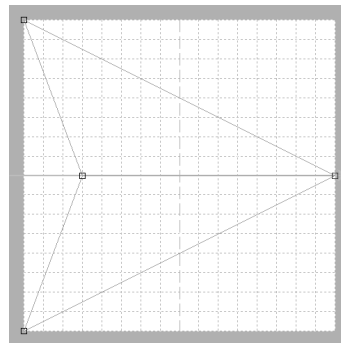
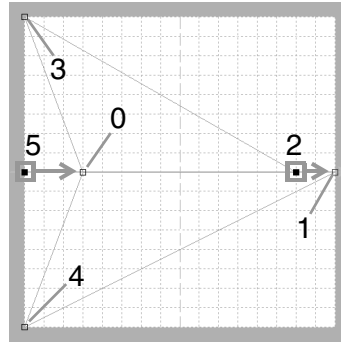

Memo:

- To move the point horizontally or vertically, hold down the **Shift** key while dragging it.
- Pressing the arrow keys moves the selected point one grid mark in the direction of the arrow on the key. If the grid is not displayed, the pattern moves a distance smaller than the smallest grid interval in the direction of the arrow on the key.
- To delete a selected point, press the **Delete** key.
- These patterns can be applied in line sewing and region sewing in Layout & Editing, and region sewing in Design Center.

Step 3 Saving the created motif stitch pattern

Motif stitch patterns are saved in the .pmf format.

- 1 Click 1, then 2.

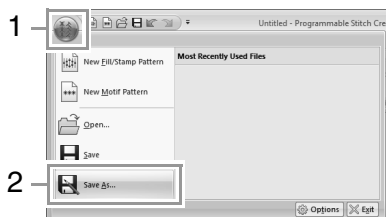

- 2 Select the drive and the folder, and then type in the file name.

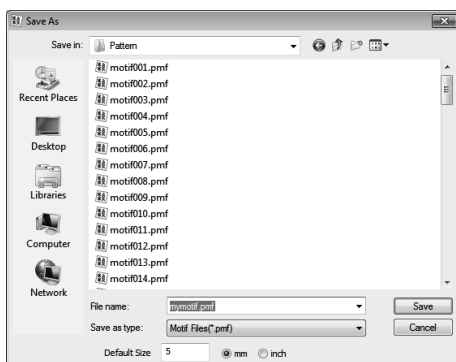

→ When saving a motif pattern, specify the size beside **Default Size**. Click **mm** or **inch** to select the measurement units.

- 3 Click **Save**.

Step 4 Using the edited motif stitch pattern in Layout & Editing

- 1 Start up Layout & Editing.
- 2 Select an embroidery pattern.
- 3 From the **Line sew type** selector (in the **Attributes** tab), select **Motif Stitch**.
- 4 Display the **Sewing Attributes** tab.

"Specifying sewing attributes" on page 58

- 5 Click below **Motif** in the **Line sew** section.

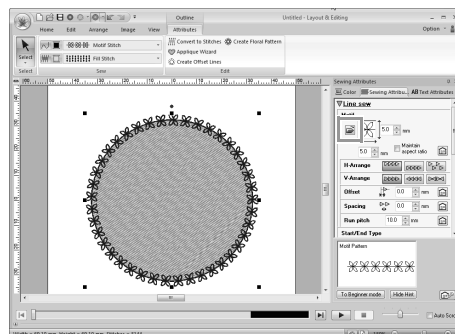

- 6 Select the drive and the folder where the pattern was saved in Step 3.

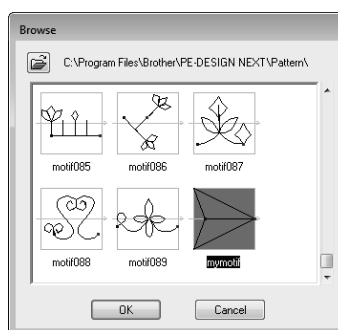

- 7 Click the created motif stitch pattern, and then click **OK**.

→ The pattern is applied to the outlines of the embroidery pattern.

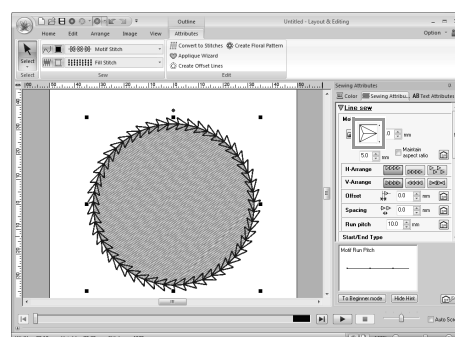

Memo:

A motif stitch pattern can be used when the motif stitch, piping stitch or stippling stitch has been selected as the sew type of a region.

Editing a pattern in Motif Mode

■ Moving and deleting several points at a time

1. Click 1, then 2.

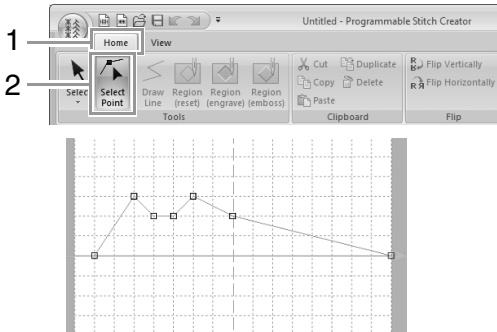

Blue square: Start point
Red square: End point

2. To select a single point, click an empty square.

To select multiple points, hold down the **Ctrl** key while clicking the points, or dragging the pointer over the points.

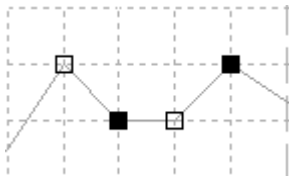

■: Selected point
□: Unselected point

Memo:

Hold down the **Ctrl** key while pressing the key or key. The selection direction changes to the end or start point.

3. Edit the points.

- To move the points, drag them to the desired location.
- To delete the point, click or press the **Delete** key.

Note:

The start point (blue square) and end point (red square) can not be deleted.

■ Scaling patterns

1. Click 1, then 2.

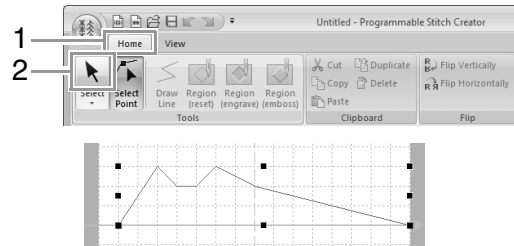

2. Drag the handle to adjust the selected pattern(s) to the desired size.

Memo:

- If the **Shift** key is held down while a handle is dragged, the pattern is enlarged or reduced from the center of the pattern.
- To flip the pattern along a vertical axis, click (1).
- To flip the pattern along a horizontal axis, click (2).

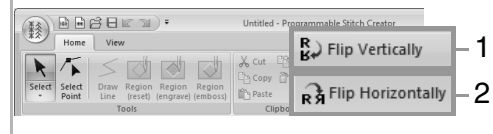

Programmable Stitch Creator Window

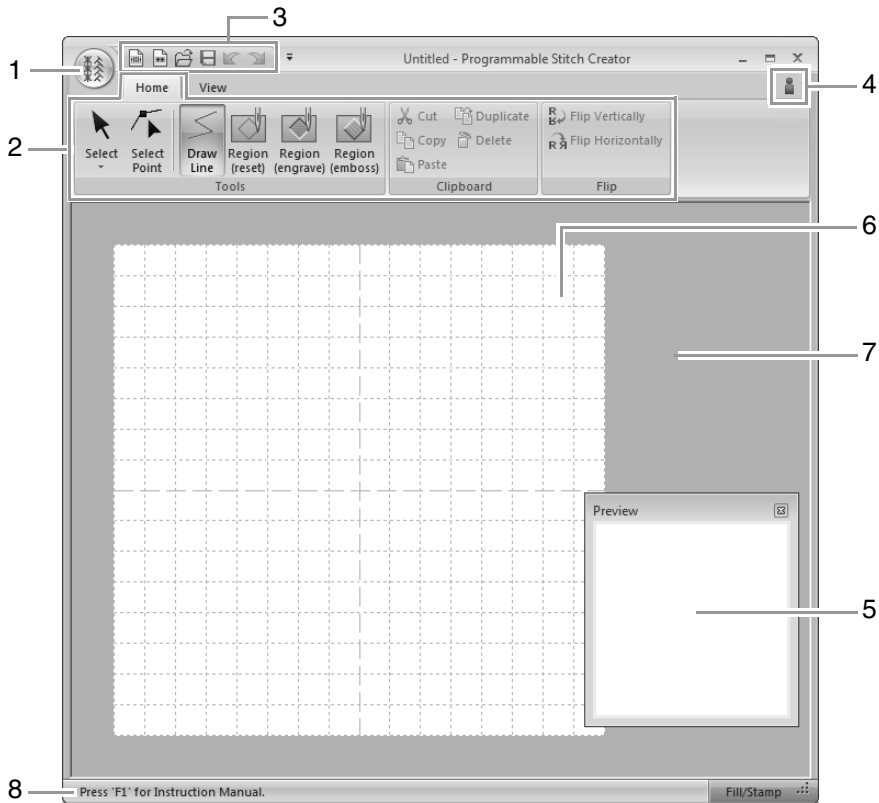

- 1 **Application button**
- 2 **Ribbon**
- 3 **Quick Access Toolbar**
- 4 **Help button**
- 5 **Preview window** (👉 p. 243)
Shows how the pattern will be sewn.
- 6 **Design Page**
- 7 **Work area**
- 8 **Status bar**
👉 "Understanding Windows" on page 19

Opening a Template

Opening an image in the background

1. Click 1, then 2.

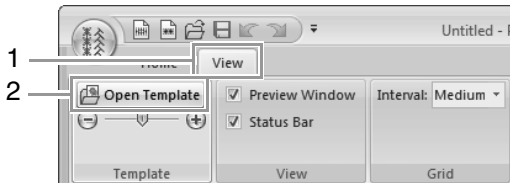

2. Select the drive, the folder and the file, and then click **Open** or double-click the file's icon.

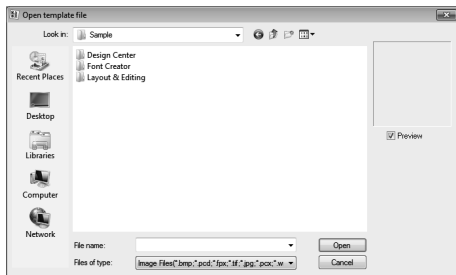

Memo:

- Only one image can be added to the work area. If you try to display a different image, it will replace the previous one.
- There are many different types of files that can be opened.

"Image file formats" on page 137

Changing the density background image

1. Click 1, and then drag the slider (2), or click or .

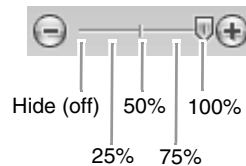
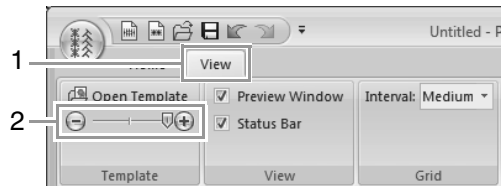

Memo:

- This function is not available if no template image has been imported into the work area.
- Press the shortcut key (**F6**) to switch between displaying the image (**On (100%)**) to displaying it faded at each density (**75%**, **50%** and **25%**) to hiding the image (**Off**).

Preview window

To switch between displaying and hiding the Preview window, click **1**, then **2**.

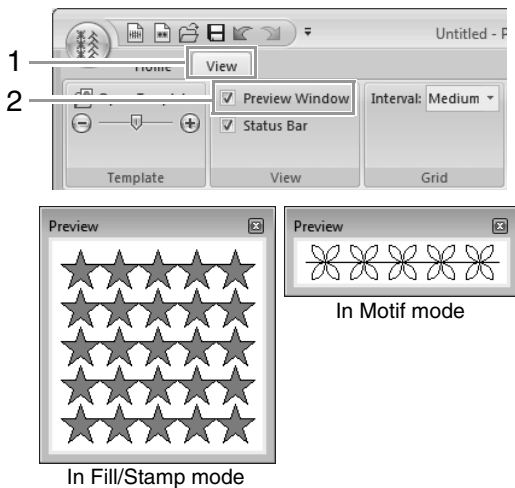

Saving Patterns

Overwriting

Click **1**, then **2**.

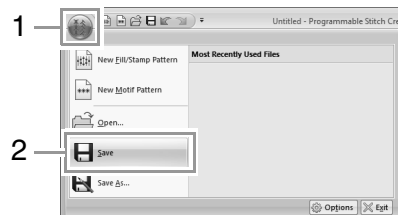

→ If no file name has been specified or if the file cannot be found, the **Save As** dialog box appears.

Saving with a new name

The files are saved as .pas files in Fill/Stamp mode, and as .pmf files in Motif mode.

1. Click **1**, then **2**.

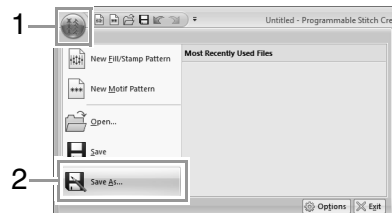

2. Select the drive and the folder, and then type in the file name.

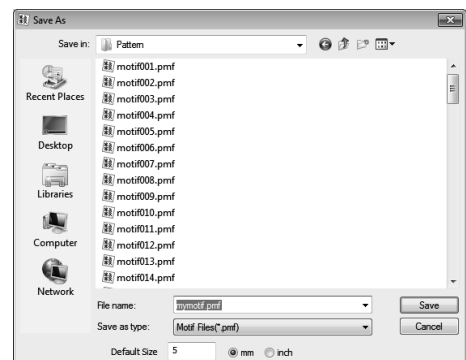

→ When saving a motif pattern, specify the size beside **Default Size**. Click **mm** or **inch** to select the measurement units.

3. Click **Save**.



Memo:

Saved files can be used in *Layout & Editing* or *Design Center*.



“Step 5 Using the edited fill/stamp stitch patterns in Layout & Editing” on page 233 and “Step 4 Using the edited motif stitch pattern in Layout & Editing” on page 239

Changing the Settings

Changing the grid settings

Click **1**, then **2**, then **3**.

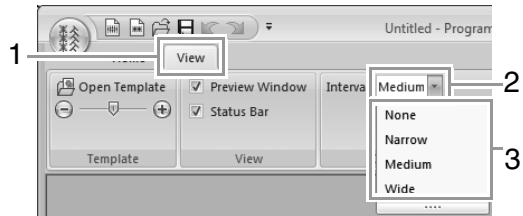

None: No grid is displayed.

Narrow: The spacing of the grid lines is changed to 1/32 of the Design Page width.

Medium: The spacing of the grid lines is changed to 1/16 of the Design Page width.

Wide: The spacing of the grid lines is changed to 1/8 of the Design Page width.

Font Creator

Custom fonts can be created using Font Creator. These fonts can be recalled to be used in Layout & Editing.

Basic Font Creator Operations

With Font Creator, custom font characters that can be used in Layout & Editing can be created and edited. Using these custom characters, original embroidery patterns can be created.

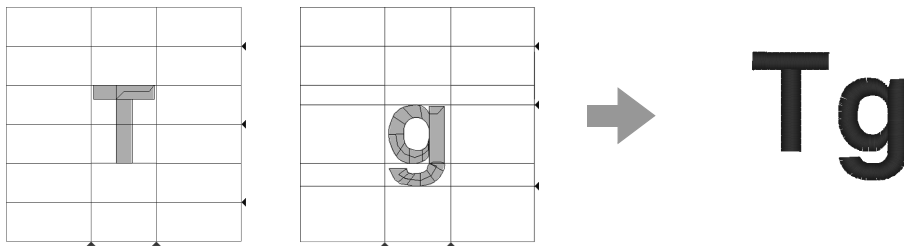

Step 1	Opening a background image
Step 2	Creating a font character pattern
Step 3	Creating other font character patterns
Step 4	Save the font character pattern
Step 5	Creating an embroidery pattern using the created font characters

Step 1 Opening a background image

1 Click (Start), then select **All Programs**, then **PE-DESIGN NEXT**, then **Tools**, then **Font Creator**.

2 Click **1**, then **2**, then **3**.

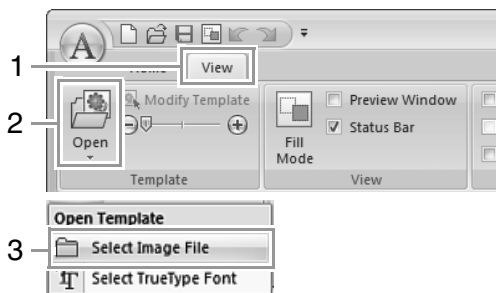

3 Import the **Capital_T.bmp**.

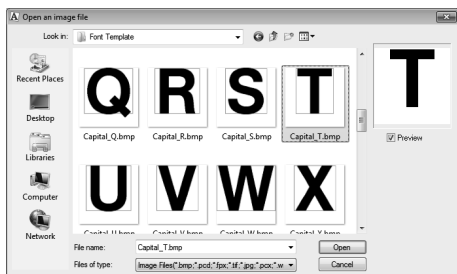

The image file can be found at the following location.

Documents (My documents)\PE-DESIGN NEXT\Sample\Font Creator\Font Template



Memo:

There are many different types of files that can be opened.



"Image file formats" on page 137

4 Move the character so that the top aligns with the **Capital Line**. To adjust the height of the character, drag a handle to adjust the height between the **Capital Line** and the **Base Line**.

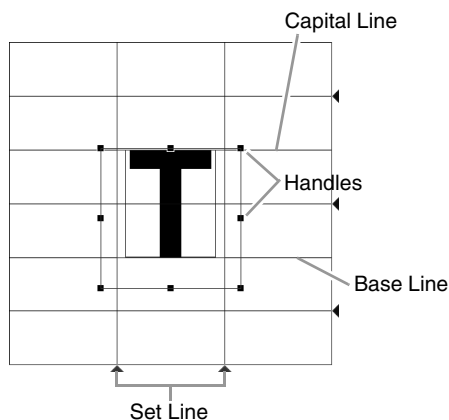

Memo:

- Red lines are added above, below and to the left and right of the sample image. Use these lines as guides for adjusting the **Base Line**, **Capital Line** and **Set Lines**.
- If the handles have disappeared, right-click the image, and then click **Modify Template** in the menu that appeared.

Step 2 Creating a font character pattern

- 1 Click 1, then 2, then 3.

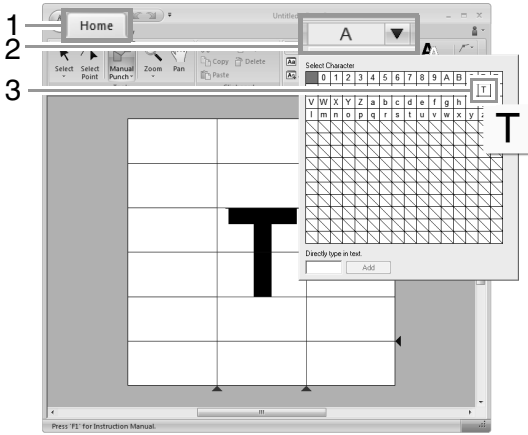

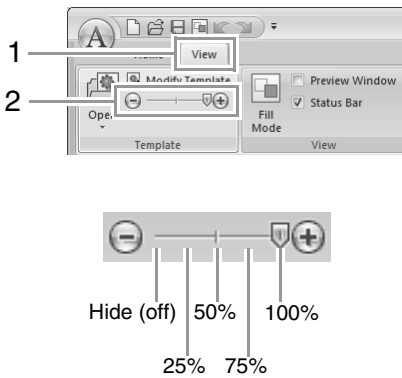

For this example, select "T".

- 2 Click 1, and then drag slider 2 to change the density of the template image. For this example, set the density to 25% as shown below.



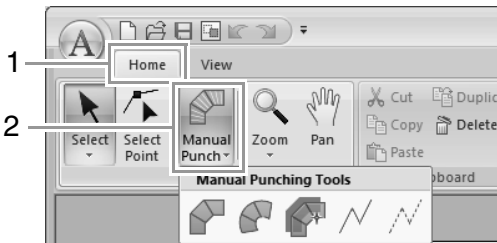

- 3 Click 1, then 2.





 : Straight block-type pattern

 : Curved block-type pattern

 : Semi-automatically created straight block-type pattern

 : Running-type pattern

 : Feed-type pattern

- 4 Click . And then click in the Design Page to specify points 1 (start point) through 4.

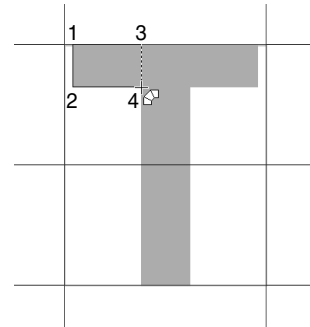

- 5 Click ; then . And then click point 5 through 7.

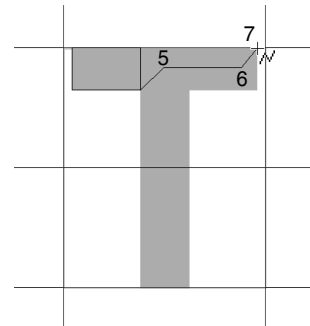

- 6 Click ; then . And then click points 8 through 10.

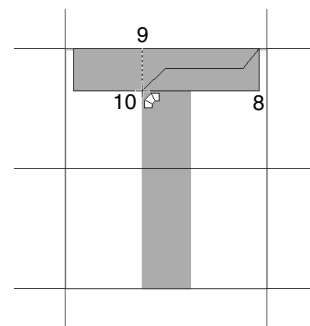

- 7 Click , then .

Memo:

By clicking  at this point, overlapping stitching can be prevented.

- 8 Click , then .

And then click points 11 through 12.

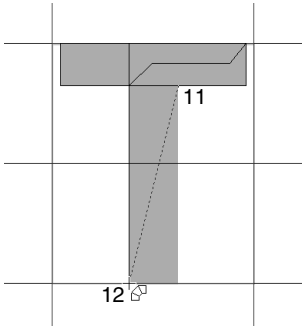

- 9 Double-click point 13 (the last point of the entire pattern), or click point 13 and press the **Enter** key.

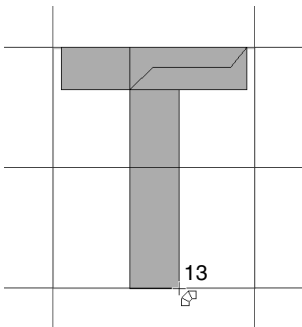

Memo:

To remove the last point that was entered, click the right mouse button, or press the **BackSpace** key.

- 10 Click **1**, then drag **Set Line** to adjust the character width.

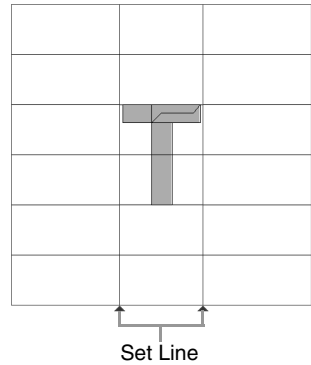
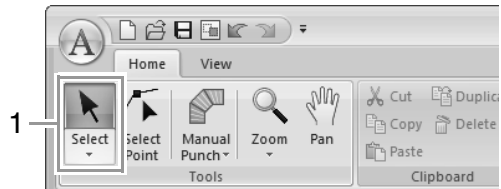

Drag the triangle icons to move the blue reference lines so that they are aligned with the top and bottom of the character.

Step 3 Creating other font character patterns

- 1 Import file **Small_g.bmp** in the same way that "T" was imported.

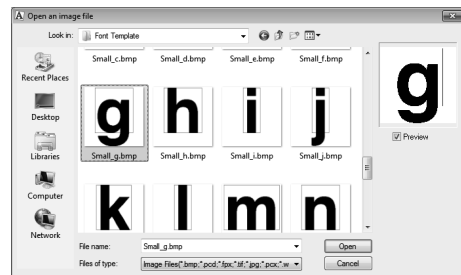

- 2 Click 1, then 2, then 3. For this example, select “g”.

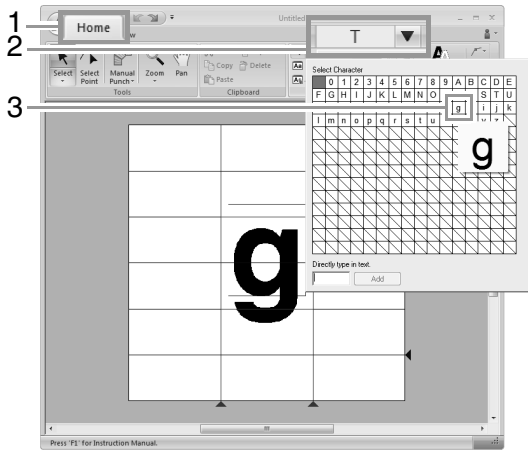

- 3 Adjust the character size and position in the same way that “T” was adjusted.

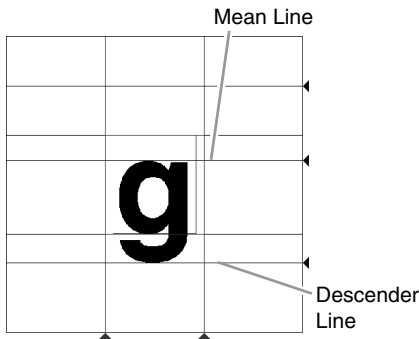

Drag the triangle icons to move the blue reference lines so that they are aligned with the top and bottom of the character.

- 4 Click , then .

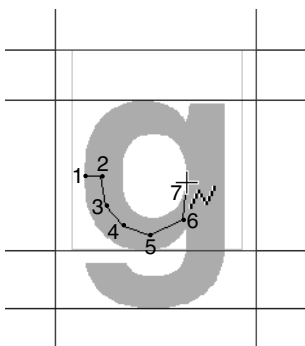

And then click points 1 through 7.



- 5 Click , then .

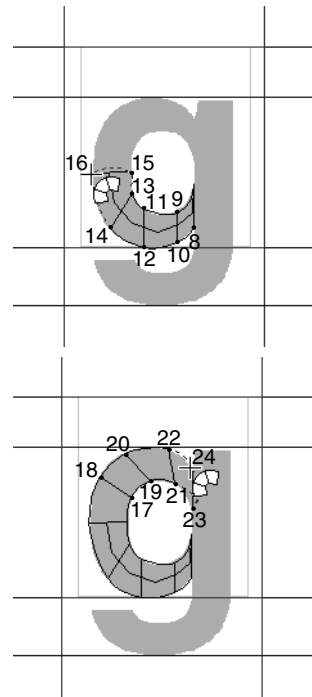

And then click points 8 through 24.



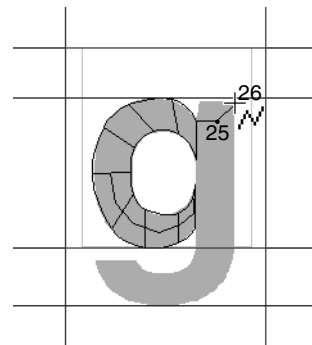

- 6 Click , then .

And then click points 25 and 26.



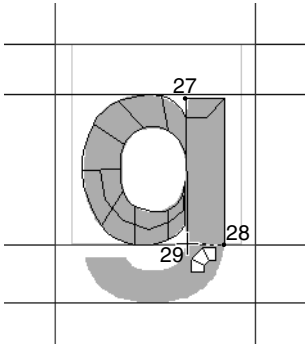

- 7 Click , then . And then click points 27 though 29.

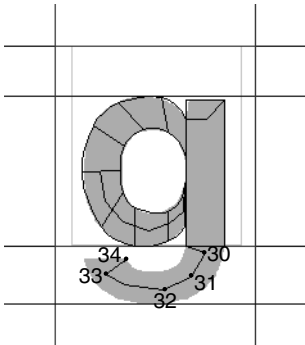

- 8 Click , then . And then click points 30 though 34.



- 9 Click , then . Next, click points 35 though 44, and then double-click point 45 (end point), or click point 45 and press the **Enter** key.

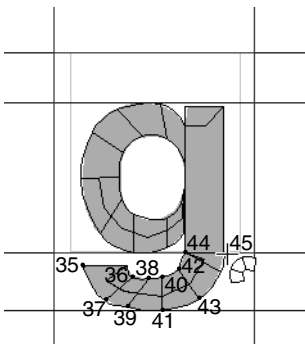

- 10 Click 1, then drag **Set Line** to adjust the character width.

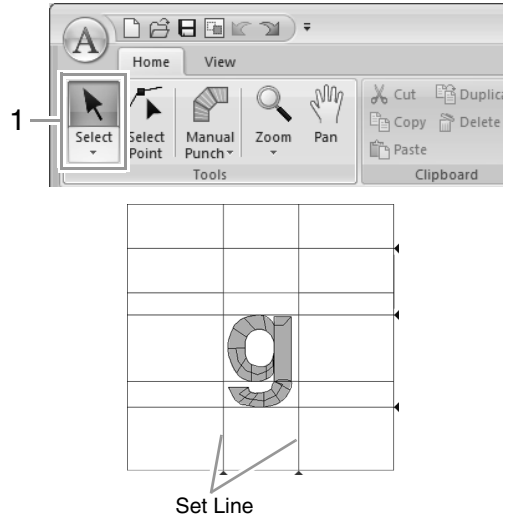

Step 4 Save the font character pattern

- 1 Click 1, then 2.

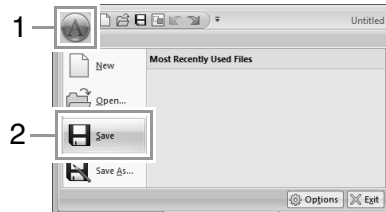

- 2 Select the **MyFont** folder at the following location.

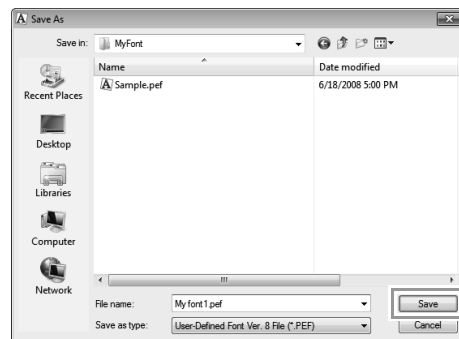

For example, (Drive where PE-DESIGN was installed)\Program Files (Program Files (x86))\Brother\PE-DESIGN NEXT\MyFont. And then type in the file name. For this example, type in the name "My font 1". Click **Save**.

Note:

- The created font is saved in the **MyFont** folder at the following location.
- The font will not be usable in the Layout & Editing if it's stored in a different folder. For example, (Drive where PE-DESIGN was installed)\Program Files (Program Files (x86))\Brother\PE-DESIGN NEXT\MyFont.
- If any part of the character pattern extends off the Design Page, a message appears. Edit the character pattern so that no part extends off the Design Page, and then save it again.

Memo:

If the background image is displayed, the information for the background image will be saved with the font file. The next time that the font file is opened, the background image is displayed.

Step 5 Creating an embroidery pattern using the created font characters

- 1 Start up Layout & Editing.

Note:

If Layout & Editing is already started, exit it, and then start it again. The new font is detected when the application starts up.

- 2 Click 1, then 2, then 3.

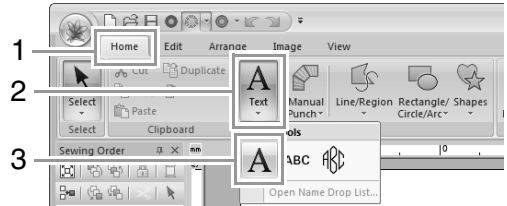

- 3 Click in the Font selector, and then select "My font 1".

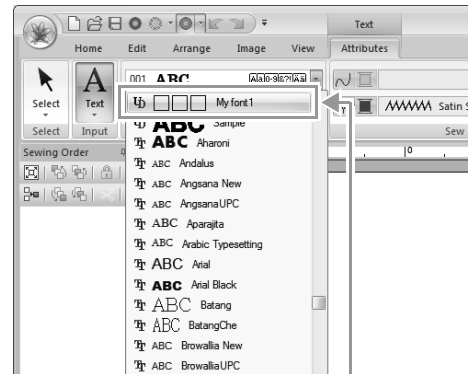

Fonts created in Font Creator appear with the  icon in front of the font name.

Memo:

Since fonts for only "T" and "g" were created in the previous examples ("A", "B", "C", etc. were not created), only these characters appear in the sample when **Font** selector is clicked.

4 Click in the Design Page.

Input the text, and then press **Enter** the key or click the Design Page.

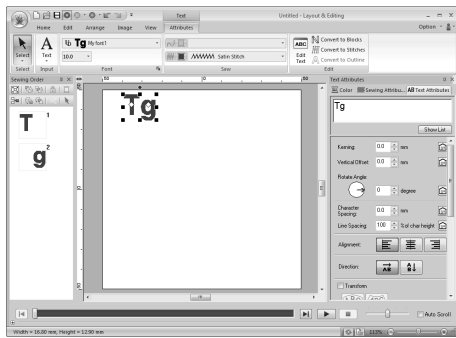
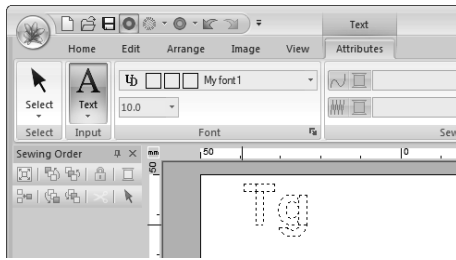

“Creating Embroidery Patterns Containing Text” on page 89

Font Creator Window

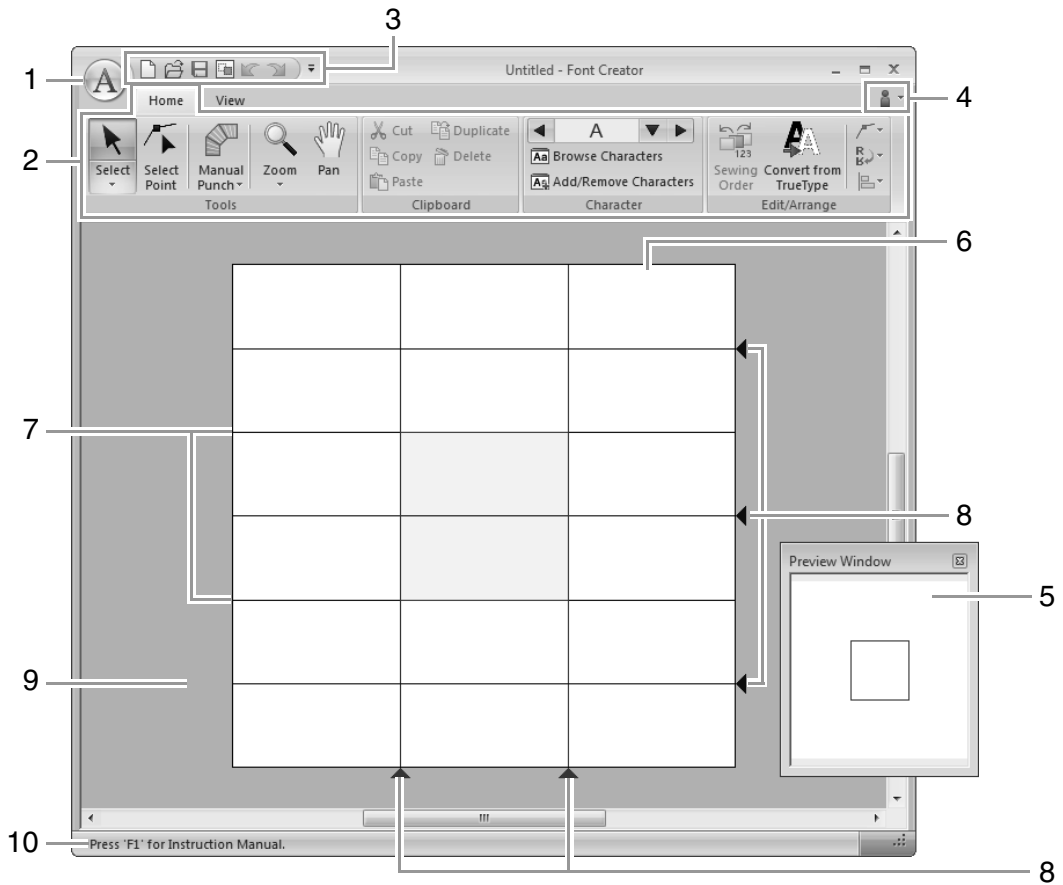

- 1 **Application button**
- 2 **Ribbon**
- 3 **Quick Access Toolbar**
- 4 **Help button**
- 5 **Preview window** (☞ p. 261)
Shows how the stitch pattern will be sewn.
- 6 **Design Page**
- 7 **Guidelines (fixed)** (☞ p. 254)
- 8 **Guidelines (movable)** (☞ p. 254)
- 9 **Work area**
- 10 **Status bar**

☞ "Understanding Windows" on page 19

About the Design Page guidelines

The standard guidelines for creating fonts are shown in the Design Pages. The contents of each of the guidelines are as shown below.

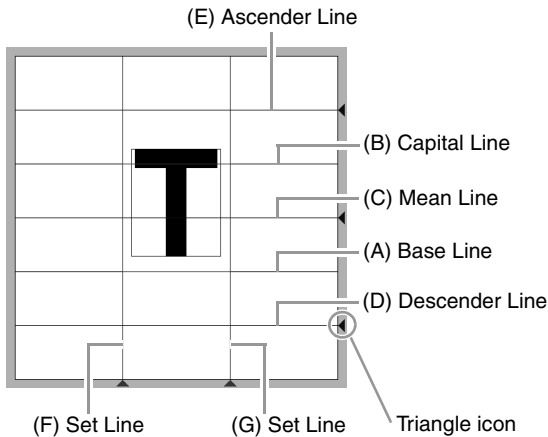

(A) Base Line

(B) Capital Line

The font's standard height will be from the **Base Line** to the **Capital Line** line. These line cannot be moved.

(C) Mean Line

When in lower case, the standard height of the font will be from the **Base Line** to this line. It can be moved by dragging the triangle icon on the right edge.

(D) Descender Line

This line is the standard for characters with parts that hang down (descenders) such as "g" and "y". It can be moved by dragging the triangle icon on the right edge.

(E) Ascender Line

This line is the standard for characters with parts that extended above (ascenders) such as the accent mark. It can be moved by dragging the triangle icon on the right edge.

(F/G) Set Line

This line will be the font width. The font width can be adjusted by dragging the triangle icon on the bottom edge.

Memo:

- The heights and widths specified for the **Base Line**, **Capital Line** and **Set Lines** are the reference mask for creating the font character.
- When characters created with Font Creator are imported into Layout & Editing, the width and height of the characters will be in the following area.
 - Character height: from Base Line (A) to Capital Line (B)
 - Character width: from Set Line (F) to Set Line (G)
- In order to align the height of the characters, the **Ascender Line**, **Mean Line** and **Descender Line** appear the same with all characters. Therefore, if the height of any of these lines is changed, the setting is maintained, even when a different character is selected to be edited.
- The widths of the **Set Lines** can be set separately for each character.

Opening a File

Creating a new font

Click **1**, then **2**.

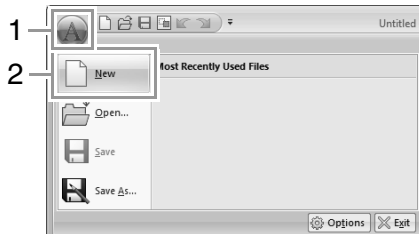

Opening a font file

1. Click **1**, then **2**.

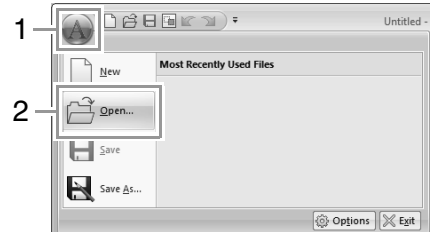

2. The created font is saved in the **MyFont** folder at the following location.
(Drive where PE-DESIGN was installed)\Program Files (Program Files (x86))\Brother\PE-DESIGN NEXT\MyFont

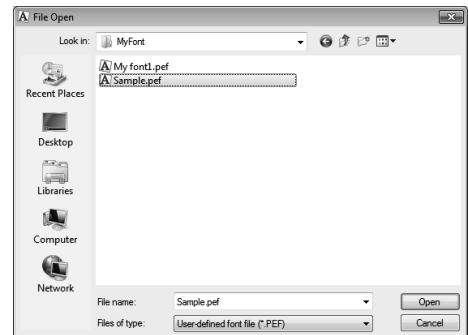

3. To open a file, select it, and then click **Open**, or double-click the file's icon.

Selecting a Character and Preparing the Template

Selecting the character to be created

Selecting from the selector

Click the left or right arrow buttons of the **Select Character** box to select a character before or after the one that is currently displayed.

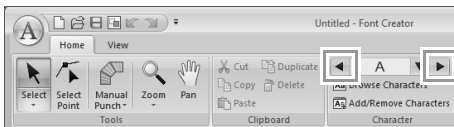

Selecting from a character list

1. Click 1, then Select Character box (2).

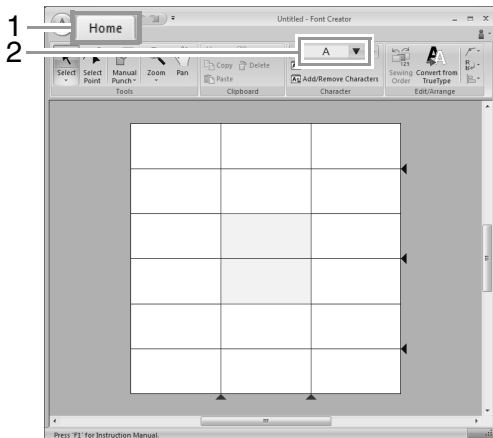

2. Click the character to be created.

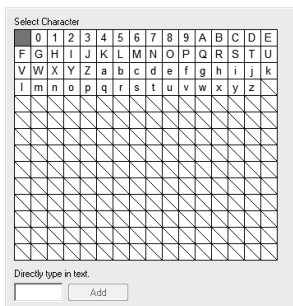

Memo:

- Characters where pattern has already been created appear with a blue background.
- The blank box in the upper-left corner is a space. Click this box to select a space.



Note:

If any part of the character pattern extends off the Design Page when a different character is selected, a message appears. Before selecting a different character, edit the character pattern so that no part extends off the Design Page.

Adding/deleting registered characters

1. Click 1, then 2.



2. From the keyboard, enter the character to be registered.

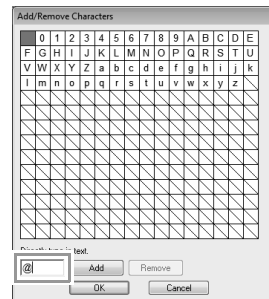

3. Click Add.

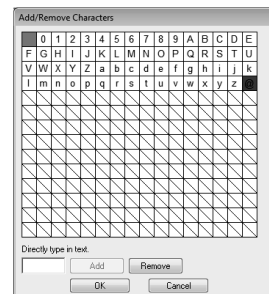

- To delete a registered character, select the character, and then click **Remove**.

The box is selected in red. Each click of the character switches between selecting and deselecting it.

- When the settings can be applied, click **OK**.



Memo:

If a character is registered even though a font has not been created, the information for the registered character is saved in a font file.

Opening a template (TrueType font)

- Click **1**, then **2**, then **3**.

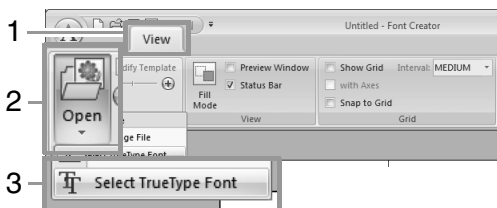

- From the **Font** selector, select the font. From the **Style** selector, select the character style. And then click **OK**.

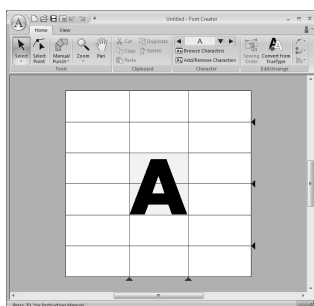
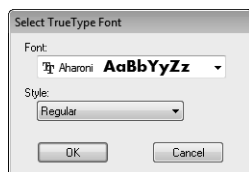

- While working on a character in a font, the same TrueType font appears until a different template is selected for the background. Each time a different character is selected in the **Select Character** box, the template of the character in the same TrueType font appears.



Memo:

- If the character selected in the **Select Character** box is not available in the TrueType font, “?” appears as the template.
- If a TrueType font was selected as the template, it cannot be moved or resized. And in this case, it can automatically be converted to a font character pattern.



“Automatically converting TrueType fonts” on page 258.

- In addition, the character cannot be drawn with the semi-automatic block-type punch tool.

Creating a Font Character Pattern

Creating patterns using the Manual Punch tools

Using the Manual Punch tools, click **1**, then **2**, then **3**.

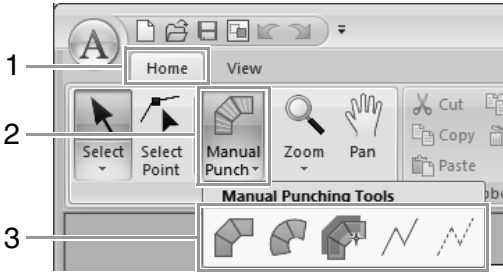



: This is used for creating straight block-type punching patterns (region sewing).
(Shortcut key: **Z**)

: This is used for creating curved block-type punching patterns (region sewing).
(Shortcut key: **X**)

: This is used for semi-automatically creating straight block-type punching patterns. By semi-automatically tracing, points can be specified along the lines of a template.
(Shortcut key: **C**)

: This is used for creating running-type punching patterns (line sewing).
(Shortcut key: **V**)

: This is used for creating feed-type punching patterns (jump stitches).
(Shortcut key: **B**)

 “Creating a font character pattern” on page 247

Memo:

- When entering points, you can switch between the various tools. This is very easy if the shortcut keys are used.
- A template image is needed in order to use the semi-automatic block-type punch tool. If there is no image, this tool will create a punching pattern like the straight block-type punch tool. In addition, this tool cannot be used if a TrueType font is used as the template.
- Once the pattern is drawn, you can still transform straight block-type patterns into curved block-type patterns and vice versa.

 For details, refer to “To Straight/To Curve” on page 260

Automatically converting TrueType fonts

1. Open the TrueType font to be used as a template.

 “Opening a template (TrueType font)” on page 257.

2. Click **1**, then **2**.

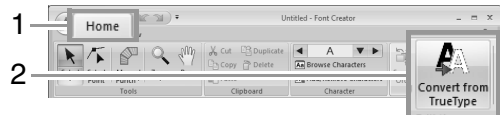

3. If a TrueType font has not been selected for the template, the **Select TrueType Font** dialog box appears.

Editing Font Character Patterns

■ Selecting patterns

1. To use the Select tool, click **1**, then **2**.

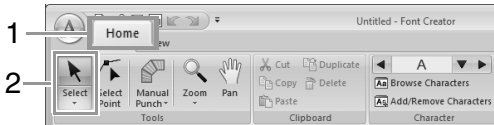

2. Click the pattern.

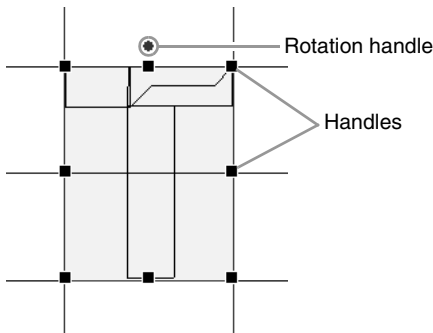

3. To select an additional pattern, hold down the **Ctrl** key and click the other pattern.

Memo:

- You can also select patterns by dragging the pointer across the pattern.
- Hold down the **Ctrl** key and click a selected pattern to deselect it.

■ Moving patterns

Selected patterns can be dragged to move them.

Memo:

- To move the pattern horizontally or vertically, hold down the **Shift** key while dragging it.
- Pressing the arrow keys moves the selected pattern one grid mark in the direction of the arrow on the key. If the grid is not displayed, the pattern moves a distance smaller than the smallest grid interval in the direction of the arrow on the key.

■ Scaling patterns

Drag a handle of the selected pattern to adjust its size. Drag the rotation handle to rotate the pattern.

Memo:

- If the **Shift** key is held down while a handle is dragged, the pattern is enlarged or reduced from the center of the pattern.
- To flip the selected pattern(s) up/down, click **1**, then **2**, then **Flip Vertically (3)**. To flip the selected pattern(s) left/right, click **1**, then **2**, then **Flip Horizontally (4)**.

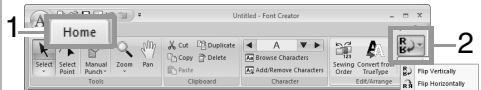

3 — Flip Vertically

4 — Flip Horizontally

- Using commands other than those mentioned above, selected patterns can be edited in other ways, for example, duplicated or deleted.

☞ “Menus/Tools” of “Font Creator” on page 291.

Editing the Points of a Font Character Pattern

Editing points and reshaping patterns

1. Click 1, then 2.

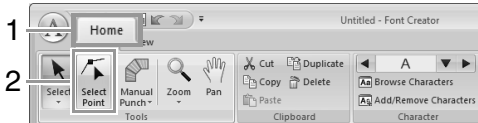

2. Click the pattern.
3. To edit a point, click the point to select it.

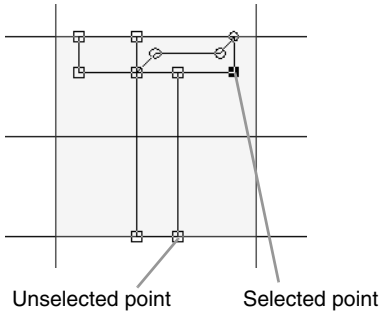

- To move the point, drag it to the new location.
- To insert a point, click the line to add a new point.
→ A new point appears selected (as a small black square or circle).
- To delete the point, click  or press the **Delete** key.

To Straight/To Curve

1. Select the point(s).
2. Click 1, then 2, then 3.

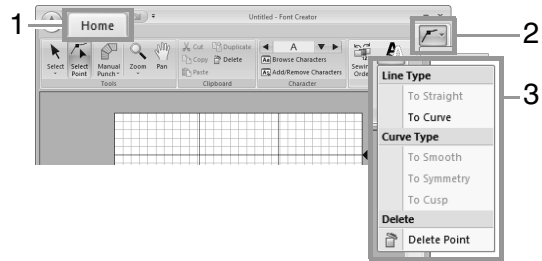



 For details on the commands *To Straight*, *To Curve*, *To Smooth*, *To Symmetry* and *To Cusp*, refer to pages 63 to 64.

Checking the Created Font Patterns

Checking and editing the sewing order

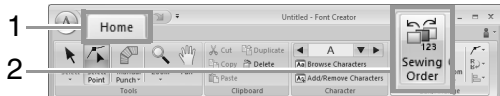
1. Click 1, then 2.



 : Click to enlarge each pattern to fill its frame.

2. Select a pattern in the **Sewing Order** dialog box.





3. The sewing order can be changed by selecting the frame containing the pattern that you want to move, then dragging the frame to the new location. A vertical red line appears, indicating the position where the frame is being moved.



An alternative method for moving the frames is by clicking the buttons at the bottom of the dialog box.

 : To move to the beginning of the sewing order.

 : To move ahead one position in the sewing order.

 : To move back one position in the sewing order.

 : To move to the end of the sewing order.

To change the sewing order, click **OK**.

Previewing the embroidery pattern

To switch between displaying and hiding the Preview Window, click 1, then 2.

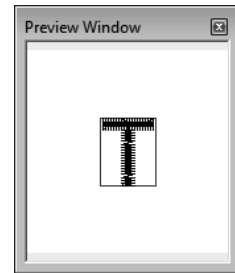
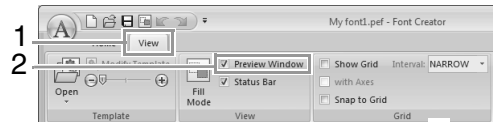

Checking and selecting from the list of created characters

A list of characters included in the font file currently being edited can be viewed.

Click **1**, then **2**.

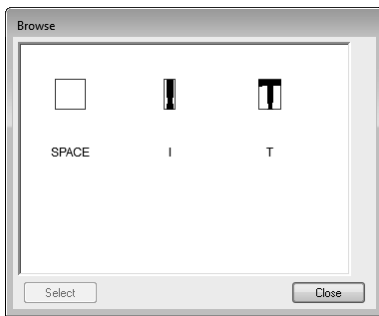
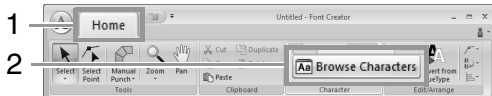

To select a character, click the character, and then click **Select**.

Saving Font Character Patterns

Overwriting

Click **1**, then **2**.

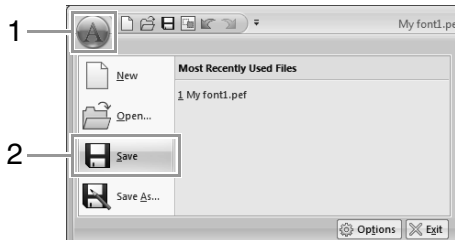

→ If no file name has been specified or if the file cannot be found, the **Save As** dialog box appears.

Note:

If any part of the character pattern extends off the Design Page, a message appears. Edit the character pattern so that no part extends off the Design Page, and then save it again.

Saving with a new name

The font character patterns are saved as .pef files.

Click **1**, then **2**.

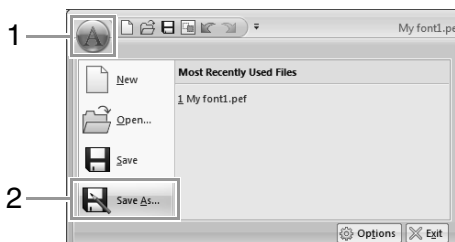

Click **2**. Select the **MyFont** folder at the following location.

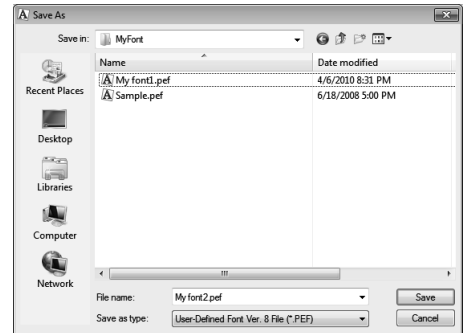

For example, (Drive where PE-DESIGN was installed)\Program Files (Program Files (x86))\Brother\PE-DESIGN NEXT\MyFont
And then type in the file name, then click **Save**.

Note:

- The font will not be usable in the Layout & Editing if it's stored in a different folder.
- The created font is saved in the **MyFont** folder at the following location.
- Saved files can be used in Layout & Editing.



"Step 5 Creating an embroidery pattern using the created font characters" on page 251

- If Layout & Editing has already started up when a new character is saved in Font Creator, that character will not appear in the Font selector list in Layout & Editing. In this case, exit Layout & Editing, and then start it up again.

Changing the Settings

Changing the drawing mode

There are two drawing modes in Font Creator.

- **Fill mode**
Blocks appear filled in. In this mode, the overlapping positions of patterns can be viewed better.

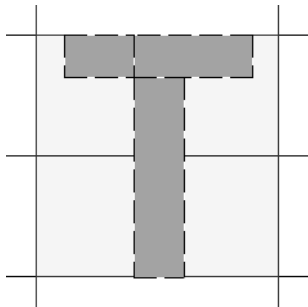

- **Outline mode (Fill mode Off)**
Blocks do not appear filled in. In this mode, points can be edited more easily.

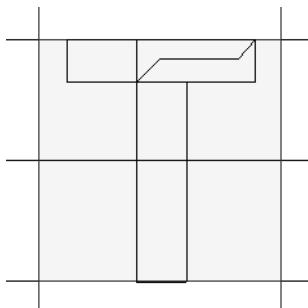

Perform the operation described below to switch between these modes.

Click **1**, then **2**.

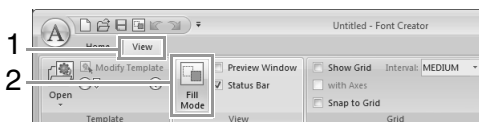

Changing the density background image

■ Changing the density of the background image

Click **1**, and then drag the slider (**2**), or click **-** or **+**.

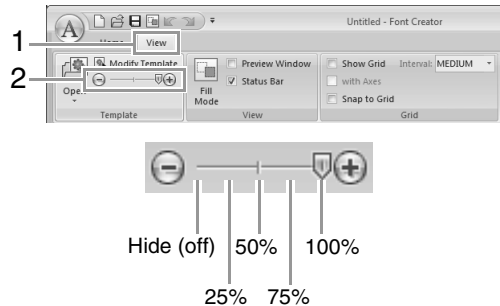

Memo:

- This function is not available if no template image has been imported into the work area.
- Press the shortcut key (**F6**) to switch between displaying the image (**On (100%)**) to displaying it faded at each density (**75%**, **50%** and **25%**) to hiding the image (**Off**).

■ Scaling/Moving the background image

Click **1**, then **2**.

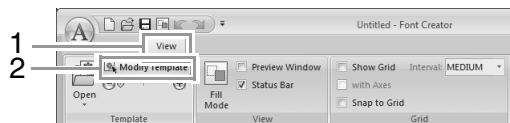

→ The background image is selected.

The background image can be moved or resized in the same way that font character patterns are edited.

☞ "Editing Font Character Patterns" on page 259.

Memo:

The background image cannot be scaled or moved if a TrueType font is used as the template.

Changing the grid settings

1. Click **View** tab.

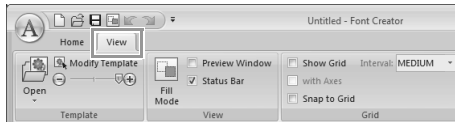

2. Specify the grid settings.

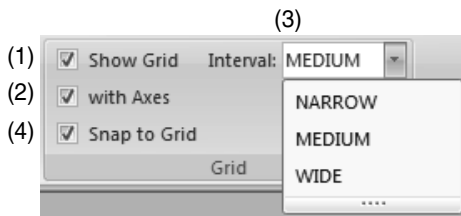

- (1) To display the grid, select the **Show Grid** check box.
- (2) To display the grid as solid lines, select the **with Axes** check box.
- (3) In the **Interval** box, select the grid spacing.
- (4) To input the font in a uniform thickness or match vertical and horizontal positions, select the **Snap to Grid** check box.

Memo:

*The pointer will move by the amount set in **Interval**.*
The snap feature works whether or not the grid is displayed.

Supplement

This section provides hints and detailed techniques for creating even more attractive embroidery.

Enlarging/Reducing Stitch Patterns

Imported stitch patterns can be enlarged or reduced in Layout & Editing in the following three ways.

- 1 Stitch patterns can be simply enlarged/reduced.
- 2 Stitch patterns can be enlarged/reduced while the **Ctrl** key is held down.
- 3 Using the Stitch to Block function, stitch patterns can be enlarged/reduced after being converted to a manual punching pattern.

With method **1**, the stitching will become more dense or light without the number of stitches sewn changing. In other words, greatly enlarging or reducing the pattern changes the quality of the embroidery since the thread density is adjusted. Use this method when only slightly enlarging/reducing the stitch pattern.

With method **2**, the size of the pattern is changed while maintaining the thread density and needle drop point pattern. However, if the original thread density and needle drop point pattern in the stitch pattern are not uniform, the thread density and needle drop point pattern may not be maintained, even by using this method. Enlarge/reduce the pattern while checking the preview. Do not use this method when only slightly enlarging/reducing the stitch pattern.

With method **3**, the thread density is maintained while the pattern is enlarged/reduced. However, the needle drop point pattern is not entirely maintained. Use this method when you wish to change the stitching or shape. Do not use this method when only slightly enlarging/reducing the stitch pattern.

This software allows you to create a wide variety of embroidery patterns and supports wider ranges for the setting of the sewing attributes (thread density, sewing pitch, etc.). However, the final result also depends on your particular embroidery machine model. We recommend that you make a trial sewing sample with your sewing data before sewing on the final material. Remember to sew your trial sample on the same type of fabric as your final material and to use the same needle and the same machine embroidery thread.

Sewing Direction

In order to limit pulling or puckering, select a stitch direction perpendicular to the larger edge of the area.

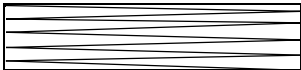

Pulling or puckering more likely to occur

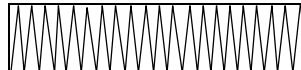

Pulling or puckering less likely to occur

Sewing Order

After creating an embroidery pattern made of several different parts (in Layout & Editing or Design Center), be sure to check the sewing order and correct it if necessary.

With Layout & Editing, the default sewing order is the order in which the elements are drawn.

With Design Center, the default sewing order is the order in which the sewing attributes are applied.

Be careful when changing the sewing order since overlapping areas may be incorrectly positioned.

Sewing Wide Areas

- For best sewing results, set **Under sewing** to **On** when sewing wide regions.

 For more details, refer to “Under sewing” on page 301.

- Changing the **Sewing Direction** setting prevents pulling-in or puckering of the stitching.
- When embroidering, use stabilizer material specifically for embroidering. Always use stabilizer material when embroidering lightweight or stretch fabrics, otherwise the needle may bend or break, the stitching may pull and pucker, or the pattern may become misaligned.
- When satin stitching is sewn in a wide area, the stitched area may shrink after sewing, depending on the material and the type of thread used. If this happens, switch to this alternate method: Select the fill stitch and use stabilizer material on the reverse side of the fabric.

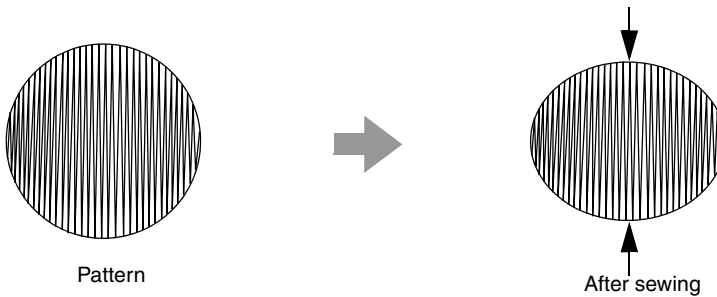

Jump Stitch and Jump Stitch Trimming

Machine thread trimming according to settings specified in Layout & Editing

If the multi-needle embroidery machine is selected in the **Design Settings** dialog box of Layout & Editing, trimming can be turned on or off at each jump stitch location.

These settings are saved in embroidery data files (.pes).

If you are using our multi-needle embroidery machine with the Jump Stitch Trimming function turned on to embroider this imported .pes file, the machine will trim the thread according to the PES data settings.

Note:

For details on the jump stitch trimming function of the machine, refer to the Operation Manual provided with your embroidery machine.

■ Specifying trimming settings in Layout & Editing

1. Select the multi-needle embroidery machine in the **Design Settings** dialog box.

 *"Specifying the Design Page Size and Color" on page 85*

2. Display the trimming locations in Layout & Editing.

 *Memo of "Changing the display of the embroidery design" on page 70*

3. Turn on/off jump stitch trimming for each embroidery pattern.

 *"Jump Stitch Trimming" on page 75*

If necessary, change settings for the following.

- Automatically turning off trimming when the jump stitch length is less than that specified.

 *"Jump Stitch Trimming" on page 75 and "About Minimum jump stitch length for thread trimming" on page 75*

- Default setting for turning on/off jump stitch trimming when a new embroidery pattern is created.

 *"Adding jump stitch trimming to new patterns" on page 275*

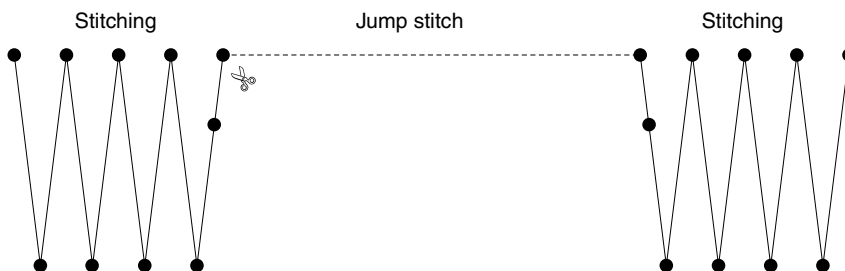

Note:

These settings are applied only when embroidering with our multi-needle embroidery machines. These settings are not applied with any other embroidery machine.

Fonts Suitable for Embroidering

■ When sewing small fonts

For best results when using your embroidery machine to embroider patterns containing small font patterns, follow the recommendations described below.

1. Reduce the thread tension to less than what is used when embroidering normal designs.
2. Sew at a speed slower than what is used when embroidering normal designs.
(For details on adjusting the thread tension and sewing speed, refer to the Operation Manual provided with your embroidery machine.)
3. Do not trim the jump stitches between the characters.
(For details on setting the machine for thread trimming, refer to the Operation Manual for the embroidery machine.)

■ When converting TrueType fonts to embroidery patterns

For best results when converting TrueType fonts to embroidery patterns, select a font where all lines are as thick as possible, such as with a Gothic font.

Converting Characters (Japanese, Chinese, Korean, etc) to Embroidery Patterns

Embroidery patterns can be created from various characters, such as Japanese, Chinese, Korean etc, using TrueType fonts.

For this example, we will create an embroidery pattern from Japanese characters.

1. Start up Layout & Editing.
2. Select a Text tool, and then select a Japanese TrueType font (for example, "MS Gothic").
3. Display a character code table different from the one that appeared in step 2. (**Start – All Programs – Accessories – System Tools – Character Map**)
4. Select **MS Gothic** from the **Font** list in **Character Map**, and then select the **Advanced view** check box. Next, select **Windows: Japanese** from the **Character set** list, select the desired character, and then click **Select**.
(This example shows the Japanese hiragana for the word meaning "Good Afternoon".)

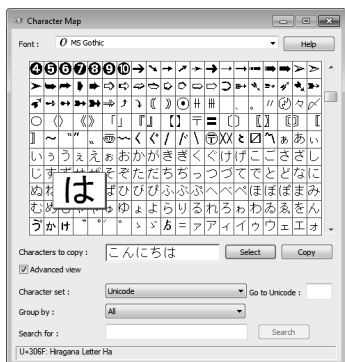

5. After selecting all of the desired characters, click **Copy** to copy the characters.
6. Click in the Design Page where you want to enter the text.

7. Paste the characters into the text field in the **Text Attributes** tab, and then press the **Enter** key.



Memo:

- The following procedure describes how to install Japanese, Chinese and Korean fonts on the English operating system for Windows® XP.

- 1) Click **Start**, select **Control Panel**, and then click **Date, Time, Language, and Regional Options**.
 - 2) Click **Regional and Language Options**, and then click the **Language** tab.
 - 3) Select the **Install files for East Asian languages** check box under **Supplemental language support**, and then click **OK**.
 - 4) Complete the Windows® installation by following the instructions that appear.
- If Japanese or Korean can be entered directly from the computer keyboard, those characters can be entered directly into the **Edit Text Letters** dialog box.

Changing the Appearance of the Application (Options)

From the **Options** dialog box, the commands appearing in the Quick Access Toolbar and settings for the application's appearance can be selected, and shortcut keys can be specified or changed. Follow the procedure described below to display the **Options** dialog box.

Click **1**, then **2**.



Memo:

The **Options** dialog box can also be displayed using either of the following methods.

- Click  at the right end of the Quick Access Toolbar, and then click **More Commands**.
- Click **Option** in the upper-right corner of the window, and then click **Options**.

Customizing Quick Access Toolbar

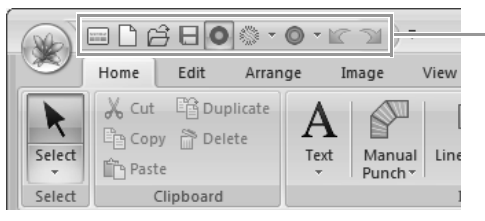

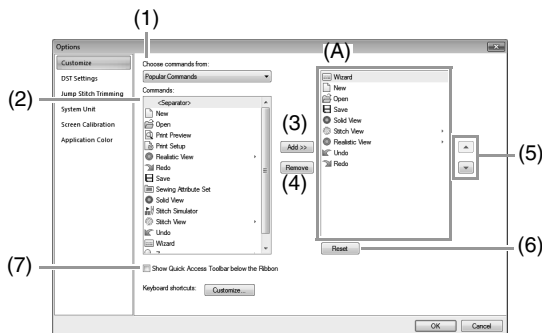

Quick Access Toolbar

1. Click **Customize**.



2. Repeat the following operations until the desired commands are displayed.

- (1) **Choose commands from:** selector
Select a command category.
- (2) **Commands:** list
Select the command to be added.
- (3) **Add** button
Selected command is added.
The command appears in (A).
- (4) **Remove** button
Selected command is removed.
The command is removed from (A).

- (5) 

Select an icon in (A), and then click the buttons at to move it to the desired position.
- (6) **Reset** button
Reverting to the default commands.

Settings for the following can also be specified from this dialog box.

- (7) **Show Quick Access Toolbar Below the Ribbon**
Select where the Quick Access Toolbar is displayed. Select the check box to display the Quick Access Toolbar below the Ribbon.

3. After the settings have been specified, click **OK** to apply them.

Customizing Shortcut keys

1. Click **Customize** (1), then **Customize** (2).

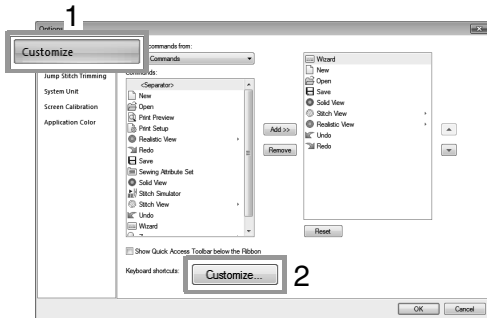

2. In the **Categories** list, select a command category. Then, in the **Commands** list, select the command whose shortcut keys are to be specified.

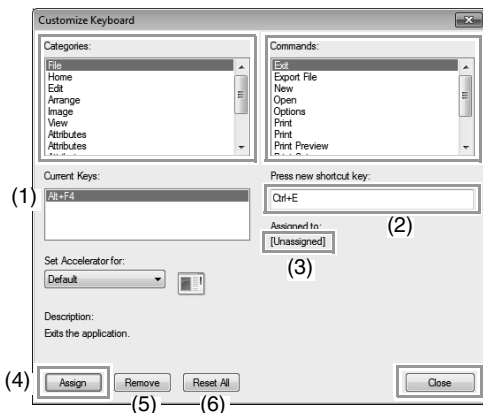

→ The default shortcut keys appear in the **Current Keys** box (1).

3. Use the keyboard to record the new shortcut keys in the **Press new shortcut key** (2) box, and then click **Assign** (4). The new shortcut keys appear in the **Current Keys** box (1).

→ Usage information about the entered key combination appears. If the key combination has already been assigned to another command, the name of that command appears at (3).

To remove the default or specified shortcut keys, select the shortcut keys in (1), and then click **Remove** (5).

To revert to the default settings, click **Reset All** (6).

4. Repeat steps 2 and 3 until the desired shortcut keys have been specified for the commands, and then click **Close**.
5. Click **OK** in the **Options** dialog box.

Customizing Application Color

The color scheme of the applications can be selected.

Click **Application Color** (1), select the desired color scheme from (2), and then click **OK**.

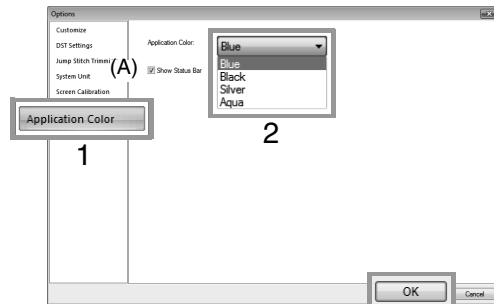

- (A) With the **Show Status Bar** check box, select whether to display or hide the status bar. To display the status bar, select the check box.

Specifying the number of jumps in embroidery design of the DST format

With the DST format, you can specify whether or not the jump stitches are trimmed according to the number of jump codes. Since the number of codes differ depending on the embroidery machine being used.

Select **DST Settings** (1), specify the number of jumps, and then click **OK**.

To specify a setting for importing, enter a value beside **DST Import Setting** (2). To specify a setting for exporting, enter a value beside **DST Export Setting** (3).

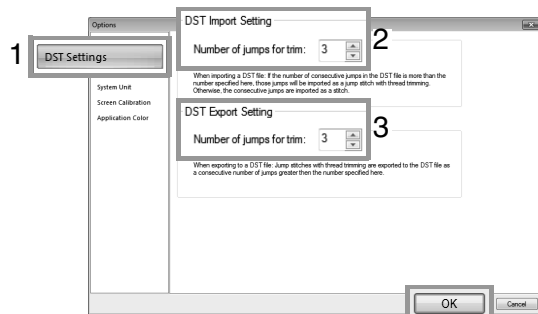

DST Import Setting

If the number of consecutive jumps in the DST file is less than the number of jumps specified here, those consecutive jumps will be replaced with a stitch.

If the number of consecutive jumps in the DST file is greater than or equal to the number of jumps specified here, those jumps will be replaced with a jump stitch where the thread is trimmed.

DST Export Setting

When .pes files are output, jump stitches with thread trimming are replaced with more consecutive jump codes than the specified number of jumps.

Adding jump stitch trimming to new patterns

When creating a new embroidery pattern for our multi-needle embroidery machines, you can specify whether or not to add jump stitch trimming to the pattern.

Note:

*These settings are applied only when embroidering with our multi-needle embroidery machines. Before these settings can be specified, select  under **Machine Type** in the **Design Settings** dialog box.*

Click **Jump Stitch Trimming** (1), and then select the **Add jump stitch trimming to the entered patterns.** check box (2). And then click **OK** (3).

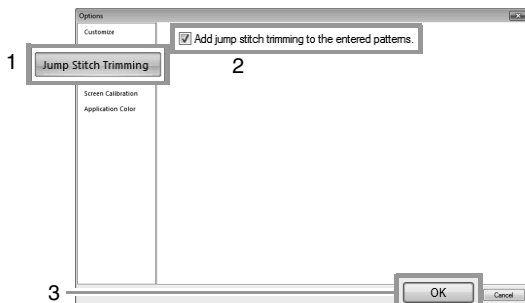

If the check box was selected, a new embroidery pattern that is created appears as shown below.

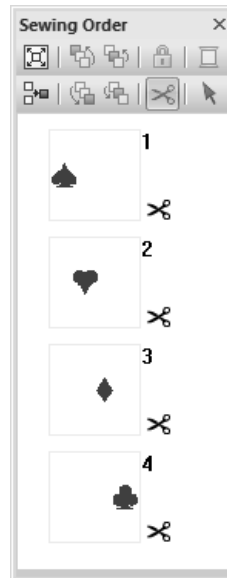

If the check box was cleared, a new embroidery pattern that is created appears as shown below.



Troubleshooting

If a problem occurs, click  or **Help**, then **Customer Support** in the menu to visit the following Web site, where you can find causes and solutions to various problems and answers to frequently asked questions.

If you have a problem, check the following solutions. If the solutions suggested do not correct the problem, contact your authorized dealer or Brother Customer Service.

Problem	Estimated Cause	Solution	Page
The software is not installed correctly.	An operation not described in the installation procedure was performed. (For example, Cancel was clicked or the CD-ROM was removed before the procedure was completed.)	Follow the instructions as the software installs to correctly install the software.	
	The installer does not automatically start up.	Refer to the memo on page 6 of the Installation Guide, "If the installer does not automatically start up".	
The message "No card writer module is connected. Please connect card writer module." appeared.	The driver for the USB card writer module is not installed correctly.	When the USB connector is correctly plugged into the USB port, the installer for the driver of the USB card writer module starts up.	If the operation described at the left does not correct the problem, go to the Web site mentioned under "Support/Service". (Refer to page 16.)
When trying to upgrade from an older version, the message "Cannot connect to the Internet." or "The server could not be connected to. Wait a while, and then try connecting again." appeared and the USB card writer module could not be upgraded.	The computer with the USB card writer module connected to its USB port could not establish a connection to the Internet.	To upgrade the USB card writer module, the computer with the card writer module connected to its USB port must connect to the Internet. If firewall software is being used, it must be temporarily disabled during the upgrade. If a connection to the Internet cannot be established, contact your authorized dealer.	
The USB card writer module does not operate correctly.	Not enough power is being supplied.	Connect the USB card writer module to a USB port on the computer or to a self-powered USB hub that can supply enough power to the card writer module.	

Menus/Tools and Reference

This section lists the various Ribbon commands and tools in each application window. For details on each command and tool, refer to the corresponding page in this manual.

This section also contains font samples and information on the various sewing attributes.

Layout & Editing

Application button menu



No.	Menu	Reference
1	New	p. 77
2	Open	p. 77
3	Save	p. 81
4	Save As	p. 81
5	Print	p. 82
6	Wizard	p. 113
7	Export File	p. 81

Ribbon menu tabs

Home tab

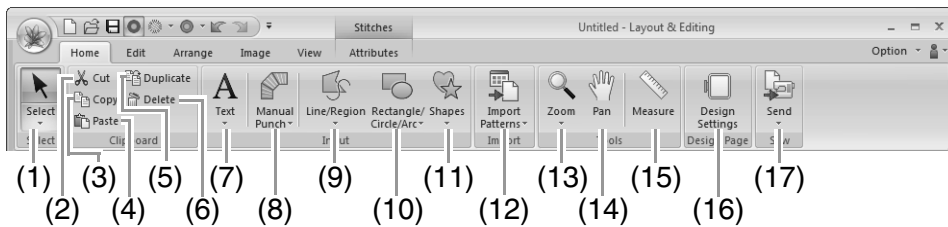

No.	Menu	Reference	No.	Menu	Reference
1	Select Tools	p. 50	10	Rectangle, Circle or Arc Tools	p. 39
2	Cut	—	11	Shapes Tools	p. 41
3	Copy	—	12	Import Embroidery Patterns	p. 79
4	Paste	—	13	Zoom Tools	p. 69
5	Duplicate	—	14	Pan Tool	p. 69
6	Delete	p. 63	15	Measure Tool	p. 69
7	Text Tools	p. 92	16	Design Settings	p. 85
8	Manual Punch Tools	p. 148	17	Sew Embroidery	p. 174
9	Outline Tools	p. 41			

■ Edit tab



No.	Menu	Reference	No.	Menu	Reference
1	Select Tools	p. 50	6	Merging	p. 47
2	Point Edit	p. 63	7	Hole Sewing	p. 45
3	Resize Selected Pattern	p. 51	8	Stamp Tools	p. 60
4	Group	p. 55	9	Convert Engrave/Emboss	p. 59
5	Remove Overlap	p. 46			

■ Arrange tab

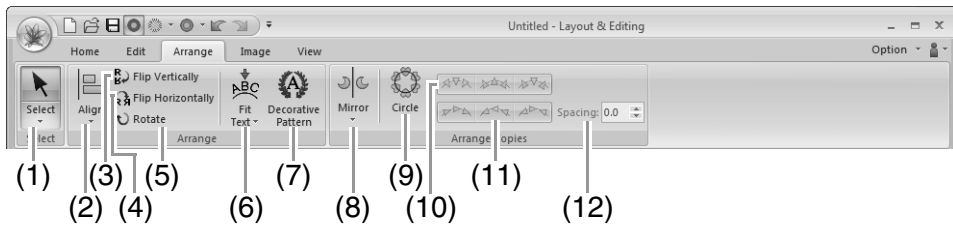

No.	Menu	Reference	No.	Menu	Reference
1	Select Tools	p. 50	7	Add Decorative Pattern	p. 54
2	Align	p. 51	8	Mirror Copy Tools	p. 53
3	Flip vertically	p. 52	9	Circle Copy Tool	p. 53
4	Flip horizontally	p. 52	10	V-Arrange	p. 53
5	Rotate	p. 52	11	H-Arrange	p. 53
6	Fit Text to outline	p. 96	12	Circle Copy Spacing	p. 53

Image tab

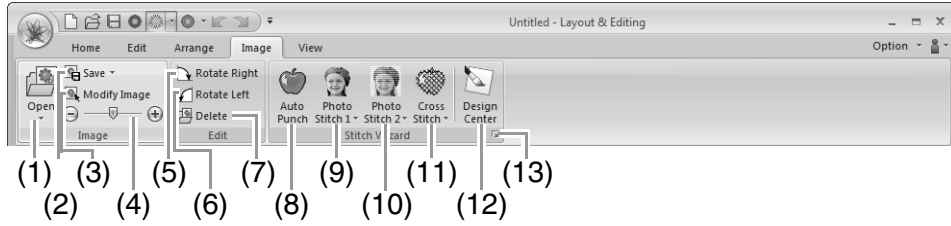

No.	Menu	Reference	No.	Menu	Reference
1	Open Image	p. 137	8	Auto Punch Wizard	p. 119
2	Save Image	p. 141	9	Photo Stitch 1 Wizard	p. 122
3	Modify Image	p. 140	10	Photo Stitch 2 Wizard	p. 127
4	Background Image Density	p. 140	11	Cross Stitch Wizard	p. 130
5	Rotate right	p. 141	12	Import to Design Center	p. 136
6	Rotate left	p. 141	13	Image to Stitch Wizard	p. 134
7	Delete Image	p. 141			

View tab

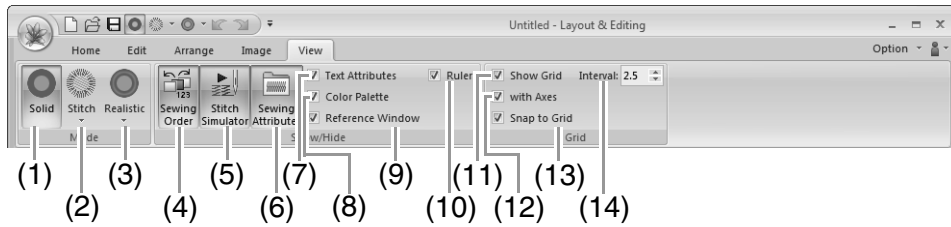

No.	Menu	Reference	No.	Menu	Reference
1	Solid View	p. 70	8	Color Palette	p. 56
2	Stitch View	p. 70	9	Reference Window	p. 72
3	Realistic View	p. 70	10	Ruler	p. 88
4	Sewing Order	p. 73	11	Show Grid	p. 88
	Jump Stitch Trimming	p. 75			
	Lock	p. 74			
5	Stitch Simulator	p. 71	12	Show Grid with Axes	p. 88
6	Sewing Attribute Set	p. 58	13	Snap to Grid	p. 88
7	Text Attribute Setting	p. 94	14	Grid Interval	p. 88

■ Attributes tab (Text)

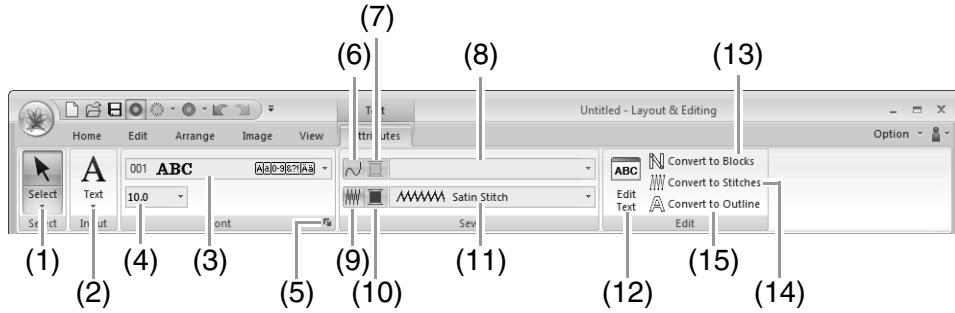

No.	Menu	Reference	No.	Menu	Reference
1	Select Tools	p. 50	9	Region sew	p. 101
2	Text Tools	p. 92	10	Region color	p. 101
3	Font	p. 93	11	Text Body Sew Type	p. 101
4	Text Size	p. 94	12	Edit Text	p. 93
5	TrueType Font Attribute Setting	p. 95	13	Convert to Blocks	p. 99
6	Line sew	p. 101	14	Convert to Stitches	p. 66
7	Line color	p. 101	15	Convert to Outline	p. 99
8	Text Outline Sew Type	p. 101			

■ Attributes tab (Manual Punch)

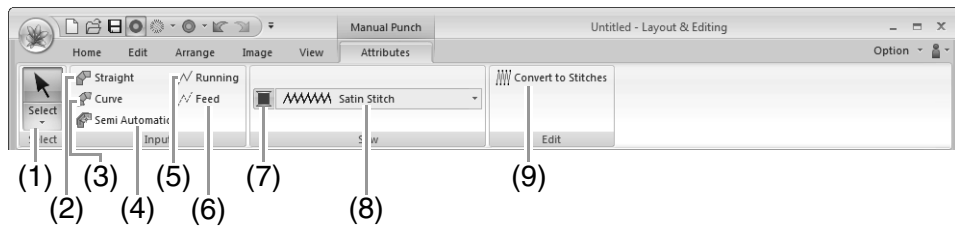

No.	Menu	Reference	No.	Menu	Reference
1	Select Tools	p. 50	6	Feed Tool	p. 149
2	Straight Block Tool	p. 149	7	Region color	p. 44
3	Curved Block Tool	p. 149	8	Block sew type	p. 44
4	Semi-Automatic Straight Block Tool	p. 149	9	Convert to Stitches	p. 66
5	Running Tool	p. 149			

■ Attributes tab (Outline)

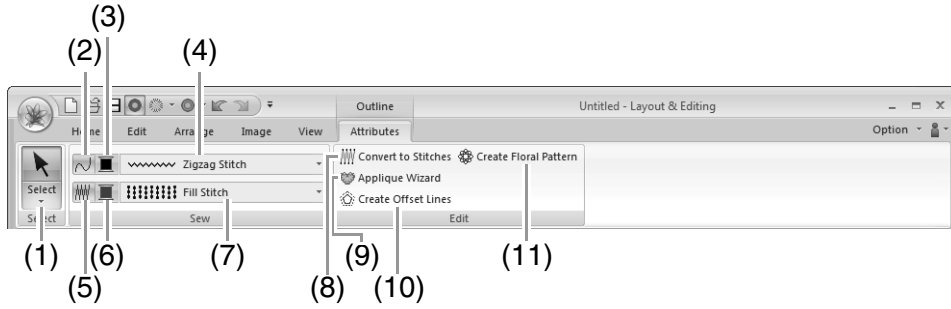

No.	Menu	Reference	No.	Menu	Reference
1	Select Tools	p. 50	7	Region sew type	p. 44
2	Line sew	p. 44	8	Convert to Stitches	p. 66
3	Line color	p. 44	9	Applique Wizard	p. 154
4	Line sew type	p. 44	10	Create Offset Lines	p. 49
5	Region sew	p. 44	11	Create Floral Pattern	p. 47
6	Region color	p. 44			

■ Attributes tab (Outline (Rectangle))

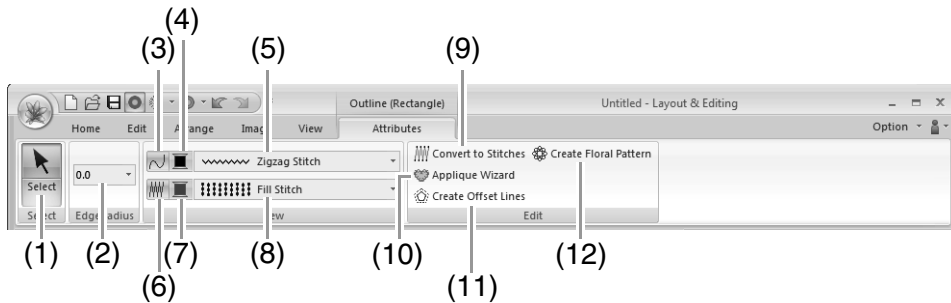

No.	Menu	Reference	No.	Menu	Reference
1	Select Tools	p. 50	7	Region color	p. 44
2	Edge radius selector	p. 40	8	Region sew type	p. 44
3	Line sew	p. 44	9	Convert to Stitches	p. 66
4	Line color	p. 44	10	Applique Wizard	p. 154
5	Line sew type	p. 44	11	Create Offset Lines	p. 49
6	Region sew	p. 44	12	Create Floral Pattern	p. 47

■ Attributes tab (Outline (Line/Region))

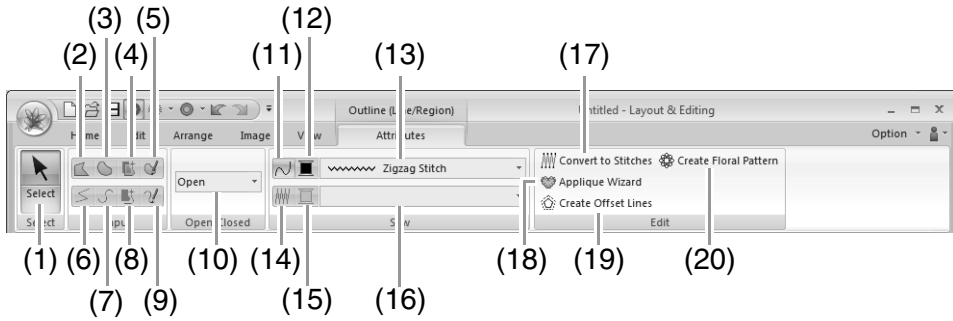

No.	Menu	Reference	No.	Menu	Reference
1	Select Tools	p. 50	11	Line sew	p. 44
2	Closed Straight Line Tool	p. 42	12	Line color	p. 44
3	Closed Curve Tool	p. 42	13	Line sew type	p. 44
4	Closed Semi-Automatic Tool	p. 42	14	Region sew	p. 44
5	Pencil (Closed Curve) Tool	p. 42	15	Region color	p. 44
6	Open Straight Line Tool	p. 42	16	Region sew type	p. 44
7	Open Curve Tool	p. 42	17	Convert to Stitches	p. 66
8	Open Semi-Automatic Tool	p. 42	18	Applique Wizard	p. 154
9	Pencil (Open Curve) Tool	p. 42	19	Create Offset Lines	p. 49
10	Path shape selector	p. 43	20	Create Floral Pattern	p. 47

■ Attributes tab (Stitches)



No.	Menu	Reference	No.	Menu	Reference
1	Select Tools	p. 50	4	Divide by Color	p. 68
2	Split Stitches	p. 68	5	Convert to Blocks	p. 67
3	Change Color	p. 66			

Design Center

Application button menu



No.	Menu	Reference
1	Wizard	p. 194
2	New Line Image	p. 197
3	New Figure Data	p. 199
4	Open	p. 195
5	Save	p. 210
6	Save As	p. 210

Ribbon menu tabs

Original Image tab

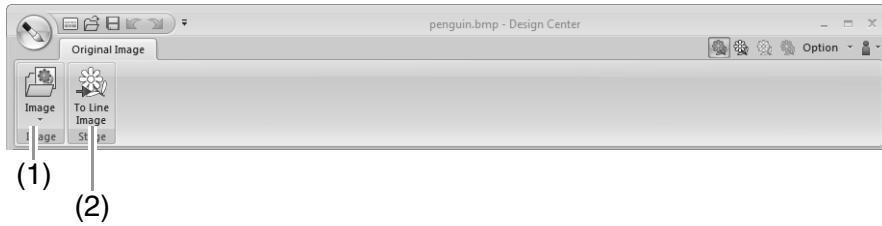

No.	Menu	Reference	No.	Menu	Reference
1	Open Image	—	2	To Line image	p. 196

Line Image tab

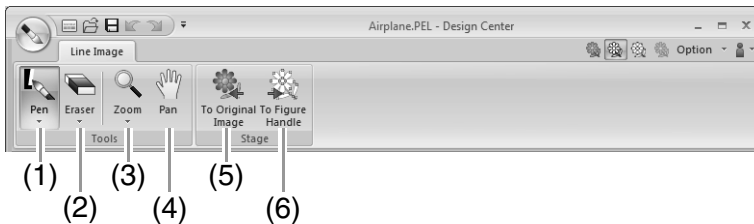

No.	Menu	Reference	No.	Menu	Reference
1	Pen Tools	p. 186	4	Pan Tool	p. 186
2	Eraser Tools	p. 186	5	To Original image	p. 194
3	Zoom Tools	p. 186	6	To Figure handle	p. 198

■ Figure Handle tab

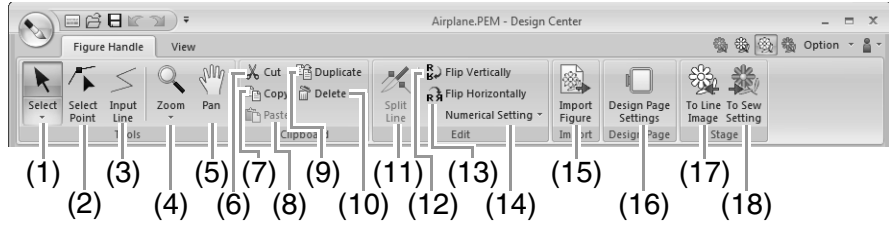

No.	Menu	Reference	No.	Menu	Reference
1	Select Tool	p. 187	10	Delete	p. 188
2	Edit Point Tool	p. 188	11	Split	p. 189
3	Line Tool	p. 187	12	Flip vertically	p. 200
4	Zoom Tools	—	13	Flip horizontally	p. 200
5	Pan Tool	—	14	Numerical Setting	p. 200
6	Cut	—	15	Import Figure	p. 199
7	Copy	—	16	Design Page Settings	p. 199
8	Paste	—	17	To Line image	p. 196
9	Duplicate	—	18	To Sew setting	p. 189

■ View tab

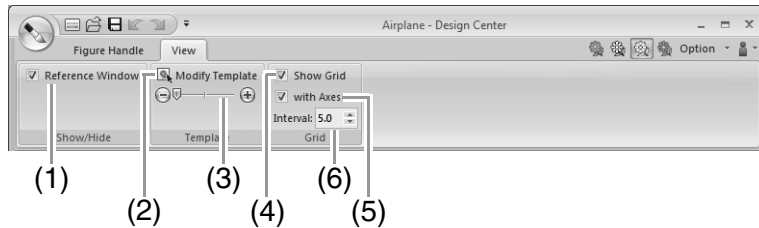

No.	Menu	Reference	No.	Menu	Reference
1	Reference Window	p. 200	4	Show Grid	p. 202
2	Modify Template	p. 202	5	Show Grid with Axes	p. 202
3	Background Image Density	p. 202	6	Grid Interval	p. 202

Sew Setting tab

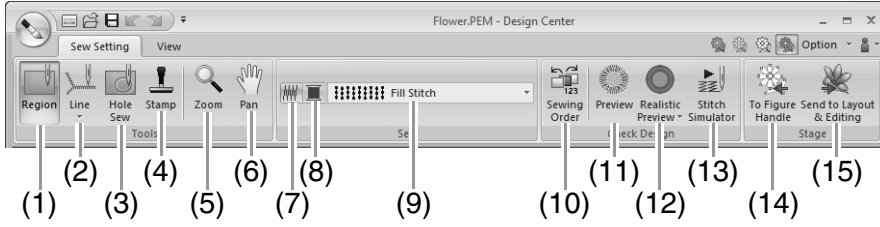

No.	Menu	Reference	No.	Menu	Reference
1	Region Tool	p. 203	9	Sew Type	p. 205
2	Line Tools	p. 204	10	Sewing Order	p. 209
3	Hole Sew Tool	p. 208	11	Preview	—
4	Stamp Tools	p. 208	12	Realistic Preview	—
5	Zoom Tools	—	13	Stitch Simulator	p. 209
6	Pan Tool	—	14	To Figure handle	p. 198
7	Sew On/Off	p. 205	15	To Layout & Editing	p. 192
8	Color	p. 205			

View tab

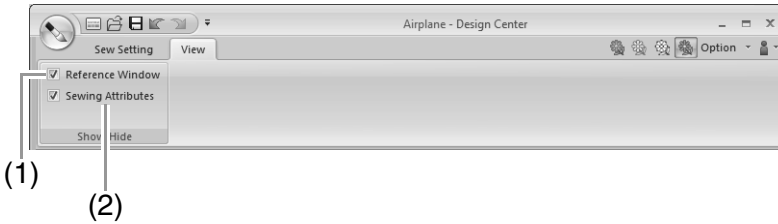

No.	Menu	Reference	No.	Menu	Reference
1	Reference Window	p. 200	2	Sewing Attribute	p. 205



Design Database

List of menus





■ File menu

Menu	Toolbar	Reference	Menu	Toolbar	Reference
Open in Layout & Editing	—	p. 216	Print Setup	—	p. 226
Import into Layout & Editing	—	p. 216	Print Preview	—	—
Create New Folder	—	p. 214	Print	—	p. 226
Convert Format	—	p. 223	Create HTML	—	p. 227
Delete	—	p. 215	Create CSV	—	p. 227
Search	—	p. 222	Exit	—	—

■ Edit menu

Menu	Toolbar	Reference	Menu	Toolbar	Reference
Cut		p. 214	Paste		p. 214
Copy			Select All	—	—

■ Display menu

Menu	Toolbar	Reference	Menu	Toolbar	Reference
Large Thumbnails		p. 215	Property		p. 224
Small Thumbnails			Refresh	—	—
Details			Toolbar	—	p. 212
Preview		p. 224	Status Bar	—	—

■ Option menu

Menu		Toolbar	Reference	Menu	Toolbar	Reference	
Select System Unit	mm	—	p. 22	Application Color	Blue	—	p. 274
	inch				Black		
Link		—	p. 221		Silver		
DST Settings		—	p. 274		Aqua		

■ Help menu

Menu	Toolbar	Reference	Menu	Toolbar	Reference
Instruction Manual	—	p. 15	About Design Database	—	—
Customer support	—	p. 16			

Programmable Stitch Creator

Application button menu

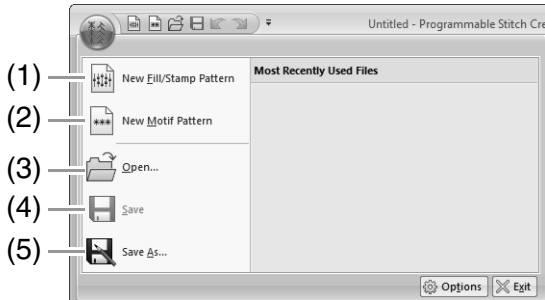

No.	Menu	Reference
1	New Fill/Stamp Pattern	—
2	New Motif Pattern	p. 237
3	Open	p. 231
4	Save	p. 243
5	Save As	p. 243

Ribbon menu tabs

■ Home tab

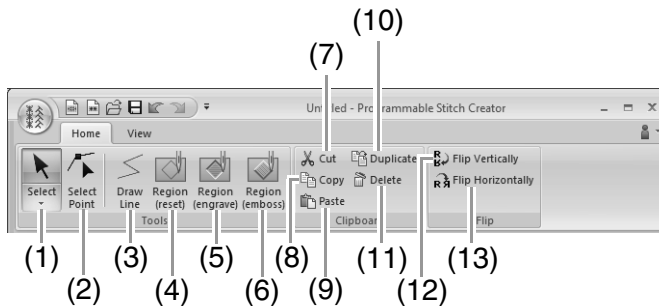

No.	Menu	Reference	No.	Menu	Reference
1	Select Tool	p. 235	8	Copy	—
2	Edit Point Tool	p. 235	9	Paste	—
3	Draw Line Tool	p. 231	10	Duplicate	—
4	Region (Reset) Tool	p. 233	11	Delete	p. 240
5	Region (Engrave) Tool	p. 232	12	Flip vertically	p. 240
6	Region (Emboss) Tool	p. 233	13	Flip horizontally	p. 240
7	Cut	—			

■ View tab

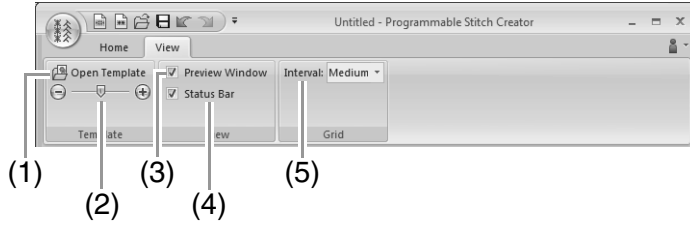

No.	Menu	Reference	No.	Menu	Reference
1	Open Template	p. 242	4	Show/Hide Status Bar	p. 241
2	Background Image Density	p. 242	5	Show Grid	p. 244
3	Show/Hide Preview window	p. 243			

Font Creator

Application button menu

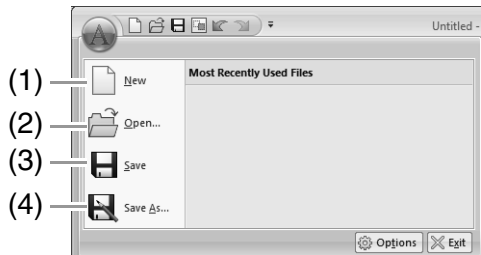

No.	Menu	Reference
1	New	p. 255
2	Open	p. 255
3	Save	p. 263
4	Save As	p. 263

Ribbon menu tabs

■ Home tab

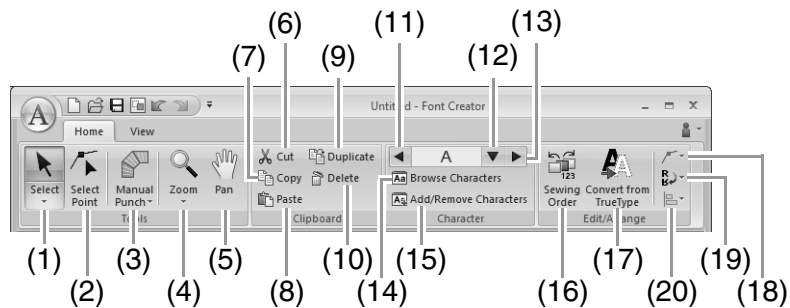

No.	Menu	Reference	No.	Menu	Reference
1	Select Object Tool	p. 259	11	Previous Character	p. 256
2	Edit Point Tool	p. 260	12	Select Character	p. 256
3	Manual Punch Tool	p. 258	13	Next Character	p. 256
4	Zoom Tool	—	14	Browse Characters	p. 262
5	Pan Tool	—	15	Add/Remove Character	p. 256
6	Cut	—	16	Sewing Order	p. 261
7	Copy	—	17	Convert TrueType Font to Data	p. 258
8	Paste	—	18	Point Edit	p. 260
9	Duplicate	—	19	Flip	p. 259
10	Delete	p. 260	20	Align	—

■ View tab

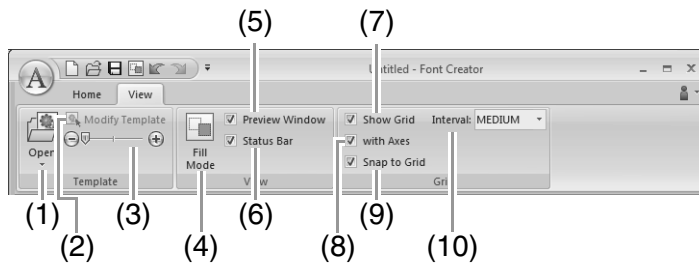

No.	Menu	Reference	No.	Menu	Reference
1	Open Template	p. 246	6	Show/Hide Status Bar	p. 253
2	Modify Template	p. 264	7	Show Grid	p. 265
3	Background Image Density	p. 264	8	Show Grid with Axes	p. 265
4	Fill Mode	p. 264	9	Snap to Grid	p. 265
5	Preview Window	p. 261	10	Grid Interval	p. 265

Sewing attributes

The sewing attributes for each sew type are first set to their default settings; however, by changing the settings of the sewing attributes, you can create custom stitching.

 For more details, refer to “Line sewing attributes” on page 296 and “Region sewing attributes” on page 301.

Line sew types

Zigzag Stitch (P.296)

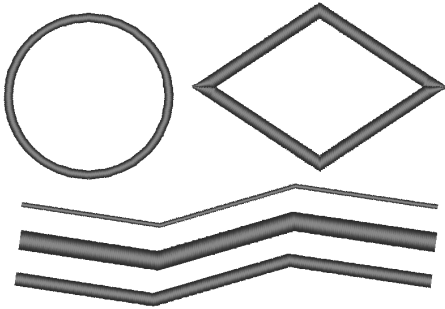

Running Stitch/Triple Stitch (P.296)

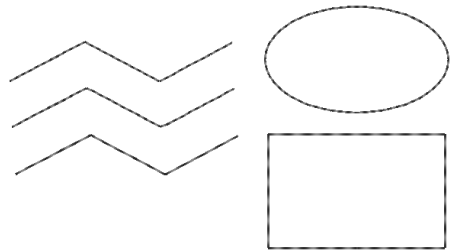

Motif Stitch (P.297)

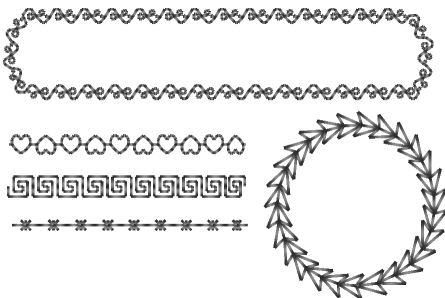

Stem Stitch (P.298)



Candlewicking Stitch (P.298)

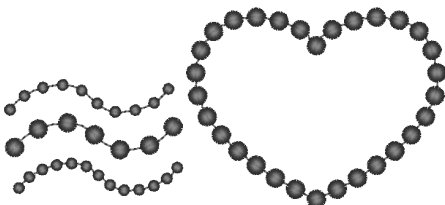

E/V Stitch (P.299)

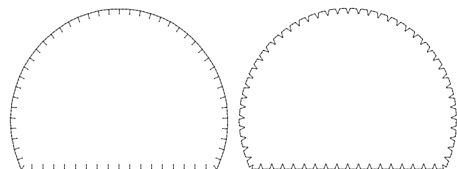

Region sew types

Satin Stitch (☞ P.301)



Fill Stitch (☞ P.303)



Programmable Fill Stitch (☞ P.303)

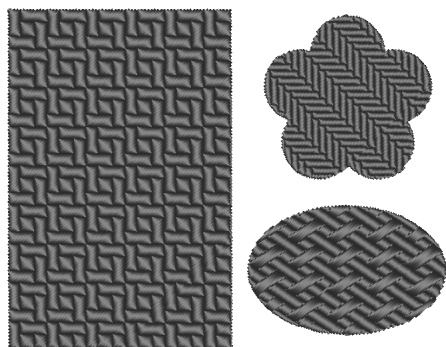

Motif Stitch (☞ P.307)

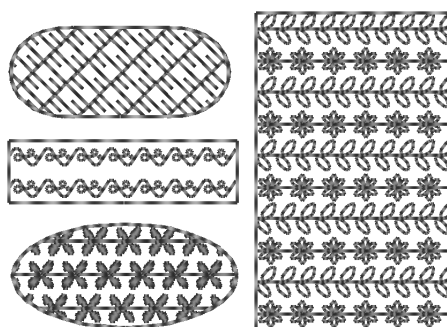

Cross Stitch (☞ P.308)

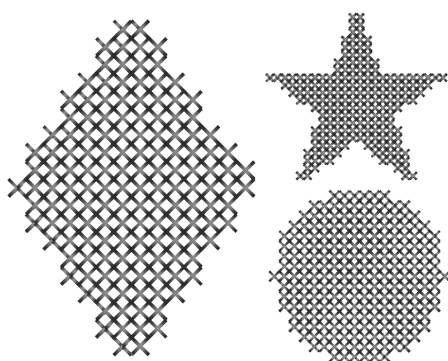

Concentric Circle Stitch (☞ P.308)

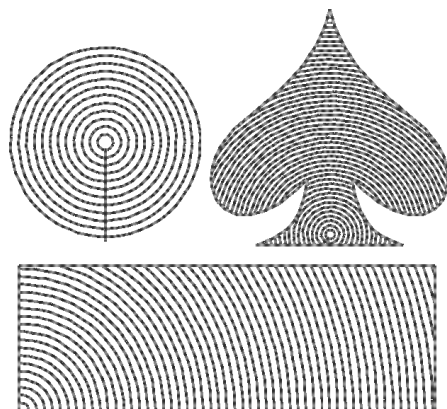

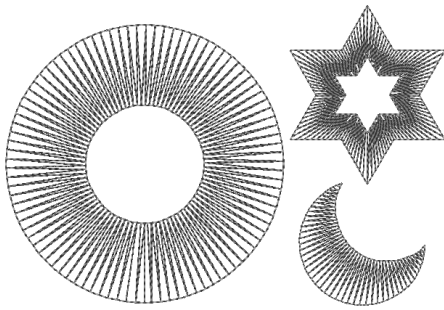
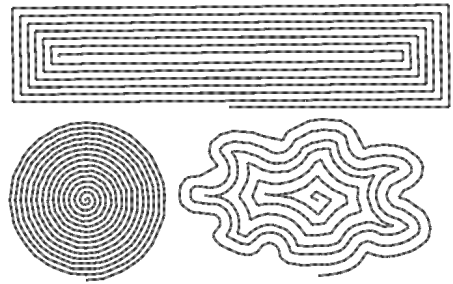
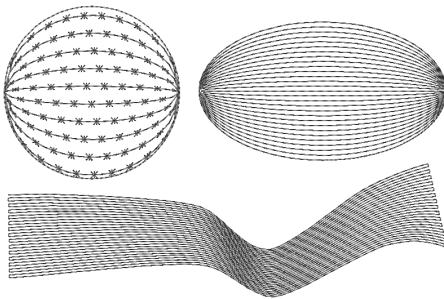
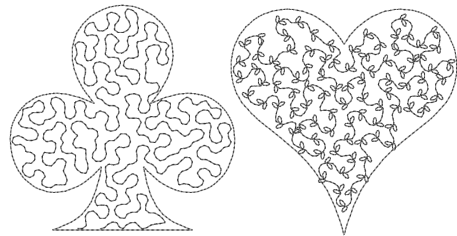





Radial Stitch (☞ P.308)**Spiral Stitch (☞ P.308)****Piping Stitch (☞ P.306)****Stippling Stitch (☞ P.308)****Memo:**

The stitching for the programmable fill stitch and the motif stitch depends on the selected stitch pattern.

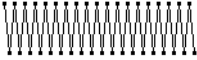
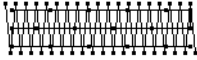
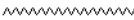
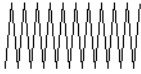

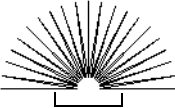
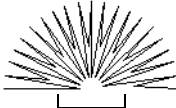

Line sewing attributes

The available attributes differ depending on the selected sew type.

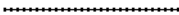

Zigzag stitch

Under sewing	Off 	On 
Zigzag width	Narrow 	Wide 
Density	Coarse 	Fine 
Half Stitch	Off  The inside stitching is dense.	On  The stitching is adjusted to a more even density.
Sharp Corners		
Connection Points	This sewing attribute is available only when a text pattern is selected.  "Selecting connection point positions in a text pattern" on page 100	













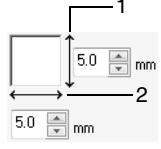
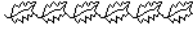

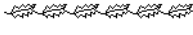

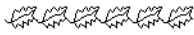

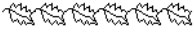



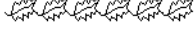



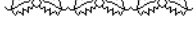

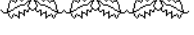

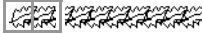
Running stitch

Run pitch	Specify the length of one stitch.	Short 	Long 
Run time(s)	Specify the number of times the outline is sewn.	1 time  x 1	5 times  x 5
Connection Points	This sewing attribute is available only when a text pattern is selected.  "Selecting connection point positions in a text pattern" on page 100		











Triple stitch

Run pitch	Specify the length of one stitch.	Short 	Long 
Connection Points	This sewing attribute is available only when a text pattern is selected.  "Selecting connection point positions in a text pattern" on page 100		



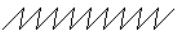







Motif stitch

	<p>Select a pattern for the motif stitch.</p> <p>Click  to display the Browse dialog box. Select a folder, and then select the desired pattern (.pmf file) from the list of patterns that appears.</p>		
	<p>Specify the pattern size. The pattern can be enlarged or reduced while maintaining the width-to-height proportion.</p>		
	<p>1 Height (vertical length)</p>	<p>Specify the pattern height.</p>	<p>Smaller  Larger </p>
	<p>2 Width (horizontal length)</p>	<p>Specify the pattern width.</p>	<p>Short  Tall </p> <p>Short  Long </p>
<p>Maintain aspect ratio</p>	<p>When selected, the height-to-width proportions of the pattern are maintained.</p>		
<p>H-Arrange (horizontal arrangement)</p>	<p>Specify the arrangement of the patterns along a horizontal axis. All patterns or each pattern can be flipped along the horizontal axis.</p>		<p> Normal </p> <p> Mirror </p> <p> Alternate </p>
<p>V-Arrange (vertical arrangement)</p>	<p>Specify the arrangement of the patterns along a vertical axis. All patterns or each pattern can be flipped along the vertical axis.</p>		<p> Normal </p> <p> Mirror </p> <p> Alternate </p>
<p>Offset</p> 	<p>0.0 mm </p>		<p>Offset: 4.5mm </p>
<p>Spacing</p> 	<p>Narrow </p>		<p>Wide </p>
<p>Run pitch</p>	<p>Specify the length of one stitch.</p>		<p>Short  Long </p>
<p>Connection Points</p>	<p>This sewing attribute is available only when a text pattern is selected.</p> <p> "Selecting connection point positions in a text pattern" on page 100</p>		
<p>Start/End Type</p>	<p>Feed </p> <p> "If the entry/exit points of sewing have been changed" on page 300</p>		<p>Run </p>











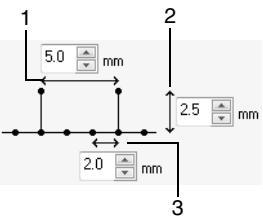
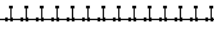
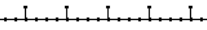
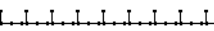
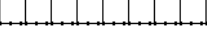
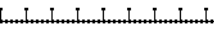
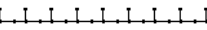
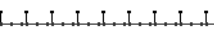
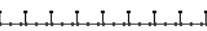
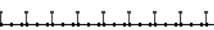
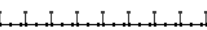
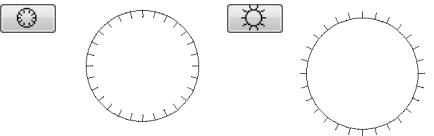

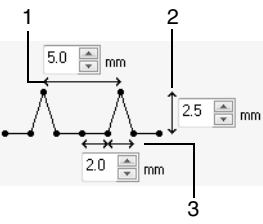
Stem stitch

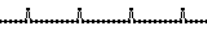
Width	Narrow 	Wide 
Space	Narrow 	Wide 
Angle	45° 	135° 
Stitch Type	Triple 	Single 
Start/End Type	Feed 	Run 
Connection Points	<p>This sewing attribute is available only when a text pattern is selected.</p> <p> <i>"Selecting connection point positions in a text pattern" on page 100</i></p>	

Candlewicking stitch

Density	Dense 	Medium 	Light 
Size	Smaller 	Larger 	
Spacing	Narrow 	Wide 	
Start/End Type	Feed 	Run 	
Connection Points	<p>This sewing attribute is available only when a text pattern is selected.</p> <p> <i>"Selecting connection point positions in a text pattern" on page 100</i></p>		

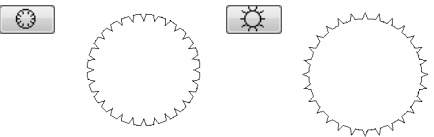
E/V stitch

	Select the E stitch or the V stitch.	
E Stitch		
	1 Interval	Narrow  Wide 
	2 Stroke width	Short  Long 
	3 Run pitch	Narrow  Wide 
Run time(s)	Specify the number of times the line is sewn.	1 time  5 times  x1 x5
Stroke time(s)	Specify the number of times each stroke is sewn.	1 time  3 times  x1 x3
Arrange		
Connection Points	This sewing attribute is available only when a text pattern is selected.  "Selecting connection point positions in a text pattern" on page 100	
V Stitch		
	1 Interval	Narrow  Wide 
	2 Stroke width	Short  Long 
	3 Run pitch	Narrow  Wide 
Run time(s)	With the V stitch, the line and the strokes are sewn the same number of times.	1 time  5 times  x1 x5
Arrange		
Connection Points	This sewing attribute is available only when a text pattern is selected.  "Selecting connection point positions in a text pattern" on page 100	

■ If the entry/exit points of sewing have been changed

If the entry/exit points of line sewing with the motif stitch, stem stitch or candlewicking stitch have been changed or optimized, select a setting for **Start/End Type** in the line sewing attributes.

👉 “Start/End Type” on page 297 and “Moving entry/exit points and the center point” on page 64

If **Feed** was selected under **Start/End Type**, jump stitches are entered at the beginning or end of pattern stitching (with a motif stitch, stem stitch or candlewicking stitch). If **Run** was selected under **Start/End Type**, running stitches following the path are entered at the beginning of and between pattern stitching.

Before the entry/exit points are changed

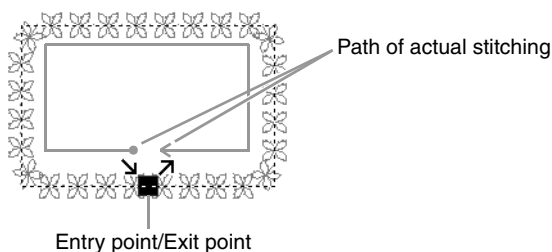

When the entry point is moved

Feed

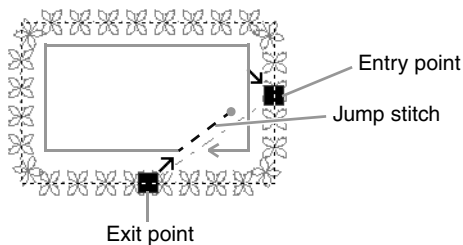

Run

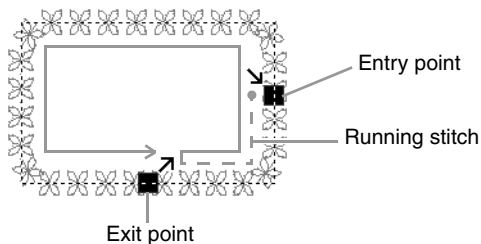

! Note:

- After changing the Start/End Type, check the stitching with the stitch simulator.



























👉 “Checking the stitching with the Stitch Simulator” on page 71



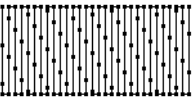
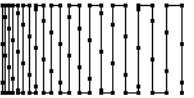

- Embroidery patterns where the Start/End Type of line sewing with the motif stitch, have been changed or optimized in an application earlier than version 8 are opened or imported with this stitching specified as jump stitches.

■ Region sewing attributes

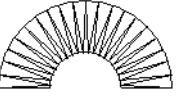
The available attributes differ depending on the selected sew type.

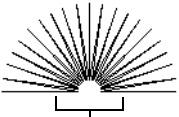
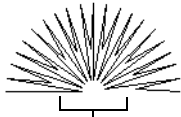
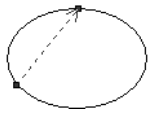
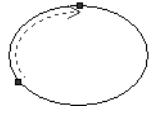
Satin stitch

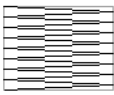
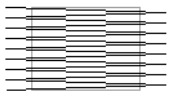
Under sewing	<p>To specify underlay stitching, select the check box, and then specify settings for the following attributes.</p> <p>Specify the type of underlay stitching to be sewn.</p> <ul style="list-style-type: none"> • With text and manual punching patterns • With other patterns 														
	<table border="1"> <tr> <td style="text-align: center;"></td> <td>Edge only</td> </tr> <tr> <td style="text-align: center;"></td> <td>Region only (single layer of zigzag shaped stitches)</td> </tr> <tr> <td style="text-align: center;"></td> <td>Region only (single layer of piping stitches)</td> </tr> <tr> <td style="text-align: center;"></td> <td>Edge and region (single layer of zigzag shaped stitches)</td> </tr> <tr> <td style="text-align: center;"></td> <td>Region only (double layer of zigzag shaped and piping stitches)</td> </tr> </table>		Edge only		Region only (single layer of zigzag shaped stitches)		Region only (single layer of piping stitches)		Edge and region (single layer of zigzag shaped stitches)		Region only (double layer of zigzag shaped and piping stitches)	<table border="1"> <tr> <td style="text-align: center;"></td> <td>Single</td> </tr> <tr> <td style="text-align: center;"></td> <td>Double</td> </tr> </table>		Single	
	Edge only														
	Region only (single layer of zigzag shaped stitches)														
	Region only (single layer of piping stitches)														
	Edge and region (single layer of zigzag shaped stitches)														
	Region only (double layer of zigzag shaped and piping stitches)														
	Single														
	Double														
<p>Density Select Dense, Medium or Light as the density for the underlay stitching.</p>															
Density		<p>Coarse Fine</p>  													
	<p>Gradation This cannot be specified under the following conditions.</p> <ul style="list-style-type: none"> • The sewing direction is set to Variable • Text and manual punching patterns <p>Click Pattern to set the gradation pattern.  <i>"Creating a gradation/blending" on page 44</i></p>	<p>Off On</p>  													
Direction	<p>This cannot be specified for text and manual punching patterns.</p> <p>Constant: Sews at a fixed angle. Drag  or select a value to specify the angle.</p>	<p>Constant</p> 													
	<p>Variable: Automatically varies the sewing direction according to the shape of the region.</p>	<p>Variable</p> 													









<p>Half Stitch</p>	<p>To specify half stitching, select the check box. This cannot be specified if the sewing direction is set to Constant.</p>	<p>Off</p>  <p>The inside stitching is dense.</p> <p>On</p>  <p>The stitching is adjusted to a more even density.</p>
<p>Running Stitch Path</p>	<p>The inside of region setting is not available if the Gradation check box is selected. This cannot be specified under the following conditions.</p> <ul style="list-style-type: none"> • The sewing direction is set to Variable. • Text and manual punching patterns 	<p><input type="checkbox"/> Inside of region</p>  <p><input type="checkbox"/> Along outline</p>  <p><input type="checkbox"/> On outline</p> 
<p>Pull compensation</p>	<p>Lengthen the sewing region in the sewing direction to adjust for pattern shrinkage during sewing.</p>	<p>No compensation</p>  <p>Longest compensation</p> 
<p>Connection Points</p>	<p>This sewing attribute is available only when a text pattern is selected.  "Selecting connection point positions in a text pattern" on page 100</p>	



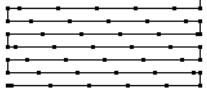

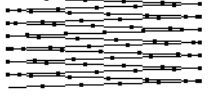
Memo:

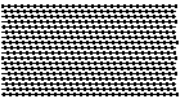
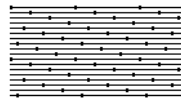
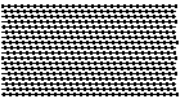
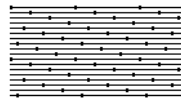
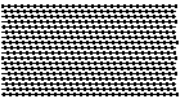
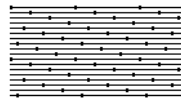
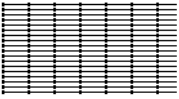
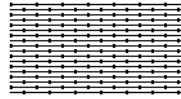
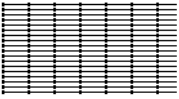
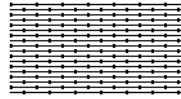
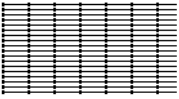
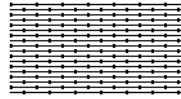

















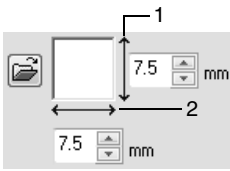











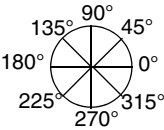
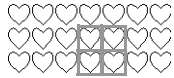







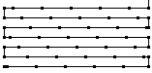

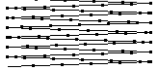

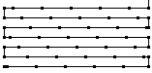

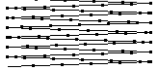
"Manually Creating Professional-Level Embroidery Patterns (Manual Punching)" on page 148

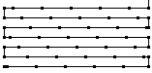
Fill stitch

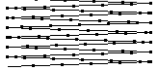
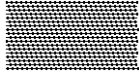
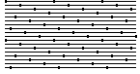
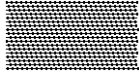
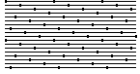
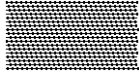
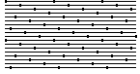
Under sewing	 <i>"Satin stitch" on page 301.</i>					
Density						
Direction						
Stitch Type	Specify the shape of the returning ends of the stitching. This cannot be specified if the sewing direction is set to variable.	   				
Half Stitch	 <i>"Half Stitch" and "Running Stitch Path" on page 302.</i>					
Running Stitch Path						
Step pitch	Specify the length of one stitch.	<table border="0"> <tr> <td>Short</td> <td>Long</td> </tr> <tr> <td></td> <td></td> </tr> </table>	Short	Long		
Short	Long					
						
Frequency		<table border="0"> <tr> <td>0%</td> <td>50%</td> </tr> <tr> <td></td> <td></td> </tr> </table>	0%	50%		
0%	50%					
						
Pull compensation	 <i>"Pull compensation" on page 302.</i>					
Connection Points	This sewing attribute is available only when a text pattern is selected.  <i>"Selecting connection point positions in a text pattern" on page 100</i>					

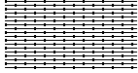
Programmable fill stitch

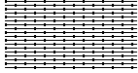
Under sewing	 <i>"Region sewing attributes" on page 301 and 302.</i>
Density	
Direction	
Half Stitch	
Running Stitch Path	
Pull compensation	
Connection Points	This sewing attribute is available only when a text pattern is selected.  <i>"Selecting connection point positions in a text pattern" on page 100</i>

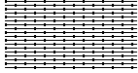
Programmable fill									
	Click  to display the Browse dialog box. Select a folder, and then select the desired pattern (.pas file) from the list of patterns that appears.								
	Specify the pattern size. The pattern can be enlarged or reduced while maintaining the width-to-height proportion. <table border="0" style="width: 100%; margin-top: 10px;"> <tr> <td style="width: 50%; text-align: center;">Smaller </td> <td style="width: 50%; text-align: center;">Larger </td> </tr> </table>	Smaller 	Larger 						
Smaller 	Larger 								
	<table border="0" style="width: 100%;"> <tr> <td style="width: 25%;">1 Height (vertical length)</td> <td style="width: 25%;">Specify the pattern height.</td> <td style="width: 25%; text-align: center;">Short </td> <td style="width: 25%; text-align: center;">Tall </td> </tr> <tr> <td>2 Width (horizontal length)</td> <td>Specify the pattern width.</td> <td style="text-align: center;">Short </td> <td style="text-align: center;">Long </td> </tr> </table>	1 Height (vertical length)	Specify the pattern height.	Short 	Tall 	2 Width (horizontal length)	Specify the pattern width.	Short 	Long 
	1 Height (vertical length)	Specify the pattern height.	Short 	Tall 					
2 Width (horizontal length)	Specify the pattern width.	Short 	Long 						
Maintain aspect ratio	When selected, the height-to-width proportions of the pattern are maintained.								
Direction									
Offset	row	0% 							
	column	<table border="0" style="width: 100%;"> <tr> <td style="width: 50%;">Row 50% </td> <td style="width: 50%;">Column 50% </td> </tr> </table>	Row 50% 	Column 50% 					
Row 50% 	Column 50% 								
Base Sewing		To specify base stitching, select the check box, and then specify settings for the following attributes.							
Stitch Type	Specify the shape of the returning ends of the stitching. This cannot be specified if the sewing direction is set to variable.	<table border="0" style="width: 100%;"> <tr> <td style="width: 50%; text-align: center;"> </td> <td style="width: 50%; text-align: center;"> </td> </tr> </table>	 	 					
 	 								
Step Pitch	Specify the length of one stitch.	<table border="0" style="width: 100%;"> <tr> <td style="width: 50%; text-align: center;">Short </td> <td style="width: 50%; text-align: center;">Long </td> </tr> </table>	Short 	Long 					
Short 	Long 								
Frequency	<table border="0" style="width: 100%;"> <tr> <td style="width: 50%; text-align: center;">0% </td> <td style="width: 50%; text-align: center;">50% </td> </tr> </table>	0% 	50% 						
0% 	50% 								

 Pattern
 Area where the embossing or engraving effects are applied

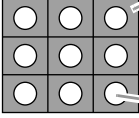
 This area is sewn with the stitching settings specified for the base sewing of the programmable fill stitch.
 This area is sewn with the stitching settings specified by the pattern file.

Notes on programmable fill stitches and stamps

In some case of the sew type and pattern directions setting of a programmable fill stitch or a stamp, lines will not be sewn.

Use the Realistic View to view exactly how the stitch pattern will be sewn. To get an even better view, make test samples of different settings.

Examples of programmable fill stitching:



Example 1
Stitch direction: 45° (default)

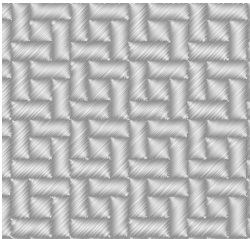

Example 2
Stitch direction: 90°

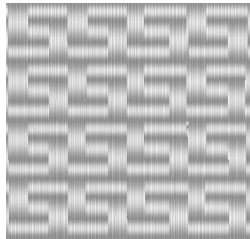



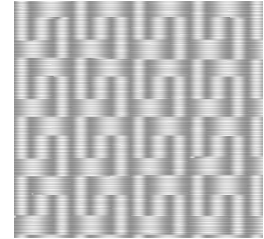





Example 3
Stitch direction: 0°

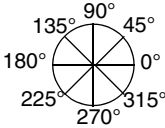

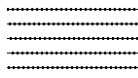
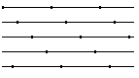









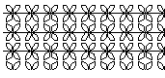
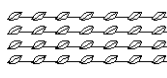
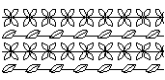

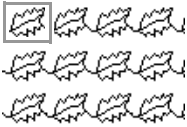
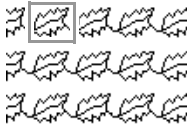
 *“Changing the display of the embroidery design” on page 70 and on “Programmable Stitch Creator” on page 229*

Piping stitch

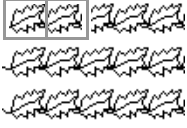
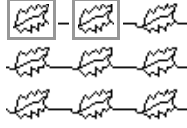
Stitching is created to run through the length of blocks.

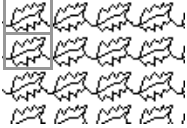
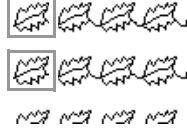
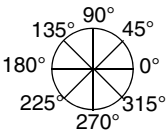
Direction	This cannot be specified for manual punching patterns.	
Specify settings for the following if the motif stitch pattern is not used.		
Density	Coarse 	Fine 
Run pitch	Specify the length of one stitch.	Short  Long 
Frequency	Specify the shift in the stitches.	0%  50% 
Use Motif	To use a motif stitch in the pattern, select the check box, and then specify settings for the following attributes.	
Motif Pattern1 only ▾	 "Motif stitch" in the "Region sewing attributes" on page 307.	
Pattern1/Pattern2 Pattern and size of the motif stitch patterns	 "Motif stitch" in the "Line sewing attributes" on page 297.	
H-Arrange		
V-Arrange		
H-Spacing		
V-Spacing	 "Motif stitch" in the "Region sewing attributes" on page 307.	
Row offset		
Run pitch		

Motif stitch

Motif <input type="button" value="Pattern1 only"/> Select the pattern to be used for the motif stitch.		Pattern1 only 	Pattern2 only 
		Pattern1 and 2 	
Pattern1/Pattern2		Specify settings for each pattern.	
Pattern and size of the motif stitch patterns Maintain aspect ratio H-Arrange V-Arrange		 "Motif stitch" in the "Line sewing attributes" on page 297	
H-Offset (horizontal spacing) 		0.0 mm 	2.5 mm 
V-Offset (vertical spacing) 		0.0 mm 	2.5 mm 
H-Spacing (horizontal spacing) 		Narrow 	Wide 
V-Spacing (vertical spacing) 		Narrow 	Wide 
Direction			
Row offset		Smaller 	Larger 
Run pitch		 "Motif stitch" in the "Line sewing attributes" on page 297	





Menus/Tools and Reference

Cross stitch



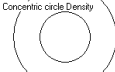
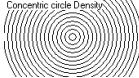

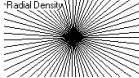
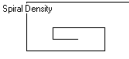
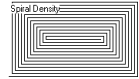
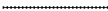
Size	Smaller 	Larger 
Times	Single  x 2	Triple  x 6

Concentric circle stitch, radial stitch and spiral stitch

For details on moving the center point of the concentric circle stitch and the radial stitch, refer to “Moving the center point” on page 65.

Density	Concentric Circle Stitch Coarse 	Concentric Circle Stitch Fine 
	Radial Stitch Coarse 	Radial Stitch Fine 
	Spiral Stitch Coarse 	Spiral Stitch Fine 
Run pitch	Specify the length of one stitch.	Short  Long 

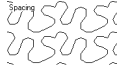
Stippling stitch

Run pitch	Specify the length of one stitch. This cannot be specified if the motif stitch is used.	Short  Long  The turns are smoother. The turns are more angled.
Spacing	Narrow  The pattern is finer.	Wide  The pattern is coarser.
Use Motif	To use a motif stitch in the pattern, select the check box, and then specify settings for the following attributes.	
Pattern and size of the motif stitch patterns	 “Motif stitch” in the “Line sewing attributes” on page 297.	
H-Arrange		
V-Arrange		
Offset		
Spacing		
Run pitch		

Manual punch

If Satin Stitch, Fill Stitch or Prog. Fill Stitch is selected as the region sew type for the manual punching pattern, feathered edge settings can be specified.

Feathered edge settings not specified

Feathered edge settings specified

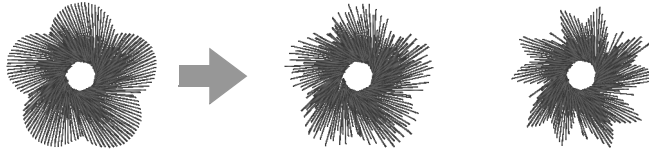

Feathered edge		Specify the edge of the stitching where the feathered edge is to be applied.	<p>Top side of pattern For <pattern11></p>	<p>Top edge only</p>
	<p>Click to display the Browse dialog box. Select the desired pattern from the list of patterns that appears.</p>	<p>Bottom side of pattern For <pattern18></p>	<p>Bottom edge only</p>	<p>Top and bottom edges</p>
<p>3.0 mm</p>	Specify the width of the feathered edge	<p>Short</p>	<p>Long</p>	

Font List

Text	
001	ABCDE abcde 012345 A a 0-9 &?! Ä ä
002	<i>ABCDE abcde</i> <i>012345</i> A a 0-9 &?! Ä ä
003	A B C D E abcde 012345 A a 0-9 &?! Ä ä
004	<i>ABCDE abcde</i> <i>012345</i> A a 0-9 &?! Ä ä
005	<i>A B C D E abcde</i> <i>012345</i> A a 0-9 &?! Ä ä
006	ABCDE abcde 012345 A a 0-9 &?! Ä ä
007	ABCDE abcde 012345 A a 0-9 &?! Ä ä
008	ABCDE abcde 012345 A a 0-9 &?! Ä ä
009	A B C D E abcde 012345 A a 0-9 &?! Ä ä
010	<i>ABCDE abcde</i> <i>012345</i> A a 0-9 &?! Ä ä
011	A B C D E abcde 012345 A a 0-9 &?! Ä ä
012	<i>ABCDE abcde</i> <i>012345</i> A a 0-9 &?! Ä ä

013	ABCDE abcde 012345 A a 0-9 &?! Ä ä
014	<i>ABCDE abcde</i> <i>012345</i> A a 0-9 &?! Ä ä
015	A B C D E abcde 012345 A a 0-9 &?! Ä ä
016	ABCDE abcde 012345 A a 0-9 &?! Ä ä
017	<i>ABCDE abcde</i> <i>012345</i> A a 0-9 &?! Ä ä
018	A B C D E A
019	<i>A B C D E</i> A
020	ABCDE abcde 012345 A a 0-9 &?! Ä ä
021	A B C D E A
022	A B C D E abcde A a
023	A . B . C . D . E. A
024	A B C D E A
025	A B C D E A
026	A B C D E A
027	ABCDE A
028	A B C D E A

Text	
029	<p>ABCDE 012345</p> <p>A 0-9</p>
030	<p><i>ABCDE abcde</i> <i>012345</i></p> <p>Aa0-9&?!Ää</p>
031	<p>ABCDE abcde 012345</p> <p>Aa0-9&?!Ää</p>
032	<p>ABCDE abcde 012345</p> <p>Aa0-9&?!Ää</p>
033	<p>ABCDE abcde 012345</p> <p>Aa0-9&?!Ää</p>
034	<p>ABCDE abcde 012345</p> <p>Aa0-9&?!Ää</p>
035	<p><i>ABCDE abcde</i> <i>012345</i></p> <p>Aa0-9&?!Ää</p>
036	<p>ABCDE abcde 012345</p> <p>Aa0-9&?!Ää</p>
037	<p>ABCDE abcde 012345</p> <p>Aa0-9&?!Ää</p>
038	<p>ABCDE abcde 012345</p> <p>Aa0-9&?!Ää</p>
039	<p>ABCDE abcde 012345</p> <p>Aa0-9&?!Ää</p>
040	<p>ABCDE abcde 012345</p> <p>Aa0-9&?!Ää</p>
041	<p><i>ABCDE abcde</i> <i>012345</i></p> <p>Aa0-9&?!Ää</p>

042	<p><i>ABCDE abcde</i> <i>012345</i></p> <p>Aa0-9&?!Ää</p>
043	<p>ABCDE abcde 012345</p> <p>Aa0-9&?!Ää</p>
044	<p>ABCDE abcde 012345</p> <p>Aa0-9&?!Ää</p>
045	<p>ABCDE abcde 012345</p> <p>Aa0-9&?!Ää</p>
046	<p>ABCDE abcde 012345</p> <p>Aa0-9&?!Ää</p>
047	<p><i>ABCDE abcde</i> <i>012345</i></p> <p>Aa0-9&?!Ää</p>
048	<p>ABCDE abcde 012345</p> <p>Aa0-9&?!Ää</p>
049	<p>ABCDE abcde 012345</p> <p>Aa0-9&?!Ää</p>
050	<p><i>ABCDE abcde</i> <i>012345</i></p> <p>Aa0-9&?!Ää</p>
051	<p><i>ABCDE abcde</i> <i>012345</i></p> <p>Aa0-9&?!Ää</p>
052	<p>ABCDE abcde 012345</p> <p>Aa0-9&?!Ää</p>
053	<p><i>ABCDE abcde</i> <i>012345</i></p> <p>Aa0-9&?!Ää</p>
054	<p>ABCDE abcde 012345</p> <p>Aa0-9&?!Ää</p>

Text	
055	ABCDE abcde 012345 A a 0-9 &?! Ä ä
056	ABCDE abcde 012345 A a 0-9 &?! Ä ä
057	ABCDE abcde 012345 A a 0-9 &?! Ä ä
058	ABCDE abcde 012345 A a 0-9 &?! Ä ä
059	ABCDE abcde 012345 A a 0-9 &?! Ä ä
060	ABCDE abcde 012345 A a 0-9 &?! Ä ä
061	ABCDE abcde 012345 A a 0-9 &?! Ä ä
062	ABCDE abcde 012345 A a 0-9 &?! Ä ä
063	ABCDE abcde 012345 A a 0-9 &?! Ä ä
064	ABXΔE αβχδε 012345 A a 0-9 &?! Ä ä
065	ABCDE abcde 012345 A a 0-9 &?! Ä ä
066	ABCDE abcde 012345 A a 0-9 &?! Ä ä
067	ABCDE abcde 012345 A a 0-9 &?! Ä ä

068	<i>ABCDE abcde</i> <i>012345</i> A a 0-9 &?! Ä ä
069	ABCDE abcde 012345 A a 0-9 &?! Ä ä
070	ABCDE abcde 012345 A a 0-9 &?! Ä ä
071	<i>ABCDE abcde</i> <i>012345</i> A a 0-9 &?! Ä ä
072	ABCDE abcde 012345 A a 0-9 &?! Ä ä
073	ABCDE abcde 012345 A a 0-9 &?! Ä ä
074	<i>ABCDE abcde</i> <i>012345</i> A a 0-9 &?! Ä ä
075	ABCDE abcde 012345 A a 0-9 &?! Ä ä
076	ABCDE abcde 012345 A a 0-9 &?! Ä ä
077	ABCDE abcde 012345 A a 0-9 &?! Ä ä
078	ABCDE abcde 012345 A a 0-9 &?! Ä ä
079	<i>ABCDE abcde</i> <i>012345</i> A a 0-9 &?! Ä ä
080	<i>ABCDE abcde</i> <i>012345</i> A a 0-9 &?! Ä ä

Text	
081	ABCDE abcde 012345 Aa0-9&?!Ää
082	ABCDE abcde 012345 Aa0-9&?!Ää
083	ABCDE abcde 012345 Aa0-9&?!Ää
084	ABCDE abcde 012345 Aa0-9&?!Ää
085	ABCDE abcde 012345 Aa0-9&?!Ää
086	ABCDE abcde 012345 Aa0-9&?!Ää
087	ABCDE abcde 012345 Aa0-9&?!Ää
088	ABCDE abcde 012345 Aa0-9&?!Ää
089	ABCDE abcde 012345 Aa0-9&?!Ää
090	ABCDE abcde 012345 Aa0-9&?!Ää
091	<i>ABCDE abcde</i> <i>012345</i> Aa0-9&?!Ää
092	ABCDE abcde 012345 Aa0-9&?!Ää
093	<i>ABCDE abcde</i> <i>012345</i> Aa0-9&?!Ää

094	ABCDE abcde 012345 Aa0-9&?!Ää
095	ABCDE abcde 012345 Aa0-9&?!Ää

Small text	
SL 01	ABCDE abcde 012345 Aa0-9&?!Ää <small>(5-6 mm)</small>
SL 02	ABCDE abcde 012345 Aa0-9&?!Ää <small>(5-6 mm)</small>
SL 03	ABCDE abcde 012345 Aa0-9&?!Ää <small>(5-6 mm)</small>
SL 04	ABCDE abcde 012345 Aa0-9&?!Ää <small>(3-4 mm)</small>
SL 05	<i>ABCDE abcde</i> <i>012345</i> Aa0-9&?!Ää <small>(3-4 mm)</small>

Monogram	
M _D Diamond	ABC XYZ
M _S Script	ABC XYZ

 **Memo:**

- A Uppercase letters of the English alphabet
- a Lowercase letters of the English alphabet
- 0-9 Numerals
- &?! Punctuation marks, brackets and other symbols
- Ää Uppercase and lowercase accented letters

(5-6 mm) Size for small text (appears only for small text)

Index

A

access key	21
aligning	
embroidery patterns	51
Application appearance	274
Application button	19
Appliqué	57, 153
Arc	40
Arrange Copies	53
attaching stabilizer	156
attributes	
Name Drop Text	111
Auto Hide	21
Auto Punch	
Parameters	121
Auto Punch function	121
Auto Scroll	71

B

Back Stitch	132
Beginner mode	58, 206
blending	6, 44
Block data	99
blocks from stitch data	67
Border Line	125, 129, 133

C

canceling	
hole sewing	46
text arrangement	97
Candlewicking Stitch	4, 293, 298
Card writer	28, 174
catalogs	
CSV files	227
HTML files	227
printing	226
center point	65
centering	50
Change Color	126, 129
changing	
thread color order	172
Changing the character spacing	98
Character Spacing	95
Check for Updates	17
checking	
sewing order	73
stitching	71
Circle	40
Circle copy	4, 53
Color button	56, 205
Color Option	126, 129
Color pane	19
combining	
pattern colors	73
concentric circle stitch	294, 308
center point	65

Connection Points	100, 296
Convert	99
Convert to Stitch	67
converting	
embroidery pattern formats	223
Copy	34
copying	
images	141
creating	
new folders	214
new thread color chart	171
cross stitch	294, 308
Cross Stitch function	130, 132
csv	112
Custom Font	93
Customer Support	16

D

Decorative pattern	54
deleting	
stitch points	67
thread color charts	171
thread colors from charts	172
Design Center	184, 284
Design Database	211, 287
Design Page Property	85, 88, 161, 199
Design Page size	85, 88, 199
multi-position hoops	161
Design Property	76
Design Property button	20
Design Setting	85, 199
displaying	
background images	242
Details	215
embroidery patterns	215
images	140, 202
Large Thumbnails	215
Small Thumbnails	215
Distributor dialog box	179
Divide Stitches by Color	68
Docking	21
drawing	
broken lines	41
portrait	138
DST format	274
DST Settings	223
Duplicate	34

E

E/V stitch	293, 299
editing	
grouped objects	55
Name Drop	111
points	62, 235
sewing order	74
Template	114, 115
thread color charts	171
thread colors	172
Emboss	59
embossing	59, 230
embroidering	159, 168

- embroidering area 162, 167
Embroidery attributes for text 100, 102
embroidery patterns
 adding comments 76
 aligning 51
 centering 50
 converting formats 223
 displaying 215
 exporting 81
 from images 6, 119, 134
 grouping 55
 importing 216
 information 76, 224
 multi-position hoops 162
 printing 165
 opening 216
 organizing 214
Engrave 59
engraving 59, 230
entry/exit points
 moving 64
 optimizing 65
eraser 186
Eraser tool 186
Expert mode 58, 206
exporting embroidery patterns 81
- F**
- Fan 40
Figure Handle stage 285
File
 New Line Image 197
 Open in Layout & Editing 216
 Search 222
File property 224
fill stitch 294, 303
Fill/Stamp mode 231
Flip 34
Floating 21
Floral pattern 4, 47
folders 214
Font Creator 245, 291
Font List 5, 310
Font selector 93
- G**
- geometric attributes
 arcs 40
 circles 40
 closed paths 43
 open paths 43
Gradation 44, 206
grid 88, 202, 244
grouping embroidery patterns 55
- H**
- Help button 19
Hide 21
Hint View 58, 206
H-Offset 307
hole sewing 45, 208
 cancel 46
hole sewing applique 154
hoop changes 163
hooping 158
- Horizontal Alignment 96
- I**
- Image to Stitch Wizard 6, 118, 134
Image Tune 135
Image Type 125
images
 converting to embroidery patterns 118, 119, 134
 moving 140
 outputting 141
 resizing 140
 saving 141
 scaling 140
importing
 .pem files 194
 background images 242
 Clipboard images 139, 194
 embroidery patterns 78, 216
 from Design Center 80
 from embroidery cards 219
 images 137, 194
 Name Drop list 112
 TWAIN images 138
Input
 from Clipboard 139
 from File 137
 from Portrait 138
 from TWAIN device 138
inserting
 stitch points 67
Installation Guide 15
Instruction Manual 15
- J**
- Jumbo frame 166
Jump Stitch 270
Jump Stitch Trimming 75, 87, 270, 275
- K**
- Kerning 95
- L**
- Large Thumbnails 215
Layout & Editing 24, 77, 278
Layout copy 53
Line color button 56
Line Image stage 284
Line Interval 129
Line sew button 56
Line sew type selector 56
line sewing attributes 296
Line Spacing 95
Link dialog box 178
Link Function 8, 177, 221
Lock 74
- M**
- Machine Type 85, 199, 212
Manual punch 309
manual punching 148
Manual Select 126
Max. Density 129

Max. Number of Colors 121, 126, 132
 Measure 22, 69
 measurement units 22, 202
 Merge 47
 Mirror
 Horizontal 200
 Vertical 200
 Mirror copy 4, 53
 Modify 140, 202
 Monograms 103, 106
 Motif mode 237
 motif stitch 293, 294, 297, 307
 moving
 center points 65
 embroidery patterns to center 50
 entry/exit points 64
 images 25, 140
 stitch points 67
 multi-position hoops 161

N

Name Drop Feature 5, 109, 111
 Name Drop List 107, 110, 111
 New 77
 New Figure Data 199
 New Line Image 197
 NOT DEFINED 57
 number of jumps 274

O

Offset 297
 Offset line pattern 4, 49
 Online Registration 16
 opening
 .pem files 194
 .pes file 77
 background images 242
 Clipboard images 139, 194
 embroidery patterns 80, 216
 images 137, 194
 Layout & Editing file 77
 new Design Page 77
 new figure handle images 194, 199
 new line images 194, 197
 new stitch pattern 237
 stitch patterns 231
 TWAIN images 138
 optimizing
 entry/exit points 65
 hoop changes 163
 Option
 Design Property 164
 Edit User Thread Chart 170
 Option button 19
 Options 273
 organizing embroidery patterns 214
 Outline 99
 Outline sewing 5, 101
 outlines
 converted from text 99
 Output
 Template 114, 115
 to Clipboard 141
 to File 141
 Oval 39

P

Pan 69, 186
 pattern information 76, 224
 adding comments 76
 multi-position hoops 164
 patterns
 selecting 73
 Pencil 43
 Photo Stitch 1 122
 Color 122
 Parameters 125
 Photo Stitch 2 127
 Color 129
 Parameters 129
 piping stitch 295, 306
 points
 editing 62, 235
 portraits 138
 Positioning Sheet 157
 Preview window 243
 previewing 70, 224
 stitch patterns 243
 Print and Stitch 6, 142
 printing
 catalogs 226
 embroidery patterns 84
 multi-position hoops 165
 instruction guide 226
 preview 84
 settings 82
 Programmable fill stitch 303
 Programmable Stitch Creator 229, 289
 Property 76
 Pull Compensation 302

Q

Quick Access Toolbar 19, 20, 273

R

radial stitch 295, 308
 center point 65
 Realistic View 70
 settings 70
 Rectangle 39
 Redo 21
 Reference Window 72, 200
 Refresh 287
 Refresh Window 20
 Refresh Window button 20
 Region color button 205
 Region sew button 56
 Region sew type selector 205
 Remove Overlaps 46
 resizing
 images 140
 Ribbon 19
 Rotate 52, 200
 Rotate angle 95
 Rotating 52
 Ruler 88
 Run Pitch 125
 running stitch 293, 296

- S**
- satin stitch 294, 301
- saving
- different formats 81
 - embroidery patterns 81, 210
 - images 141
 - Name Drop list 112
 - stitch patterns 243
 - Template 116
- scaling
- images 140
- Scaling patterns 51, 235, 240, 259
- Screen Calibration 22
- searching 222
- Select from Candidates 126
- selecting
- all embroidery patterns 50
 - colors 66, 126, 129
 - patterns 50, 73
 - sewing area 86
- Sew Page Color 125
- Sew Setting stage 286
- Sew type selector 57, 205
- Sewing Attribute pane 19
- sewing attributes 43
- setting 58, 190
- Sewing Attributes bar 204
- sewing direction
- programmable fill stitch 305
- Sewing Option 125, 129
- sewing order 73, 209
- editing 74
- Sewing Order pane 19
- Shortcut keys 274
- Small text 102
- Solid View 70
- Special colors 57
- spiral stitch 295, 308
- Split Stitch data 68
- stabilizer 156
- Stage
- To Figure Handle 198
 - To Line Image 196
 - To Sew Setting 203
- stamp attributes 60
- stamps 208
- start/end point 300
- Status bar 20
- Stem Stitch 4, 293, 298
- Step Pitch 303, 304
- Stippling stitch 295, 308
- stitch patterns
- previewing 243
 - saving 243
- stitch points
- deleting 67
 - inserting 67
 - moving 67
- Stitch Simulator 19, 71
- Stitch to Block 67
- Stitch View 70
- String 40
- T**
- Template 242, 256
- Template Wizard 113
- Text**
- Convert to Outline Object 99
- Edit Letters 92
- Fit Text to Outline Setting 96
- Release Text from Outline 97
- Text Attribute Setting 93
- TrueType Font Attribute Setting 95
- Text Attribute pane 19
- Text menu 280
- Text Orientation 96
- Text Size selector 94
- the other side 96
- Thread Chart 126, 129
- thread colors
- adding to charts 171
 - creating new colors 171
 - deleting charts 171
 - deleting from charts 172
 - editing 172
 - editing charts 171
 - new charts 170
 - order 172
 - user list 172
- Thread Colors Used 129
- Transfer 28, 217
- Transferring 174, 177
- Triple stitch 296
- TrueType Font 94
- U**
- Under sewing 296, 301
- Undo 21, 186
- Unit 22
- units of measure 22, 202
- USB cable 29, 176, 221
- USB media 175, 220
- user thread color list 170
- V**
- vector images 79
- Vertical Alignment 96
- Vertical Offset 95
- V-Offset 307
- W**
- Window 19
- wmf 79
- Z**
- zigzag stitch 293, 296
- Zoom 69
- Zoom ratio 20

