

Be sure to check the following points, before beginning work each day.

Correct crimping

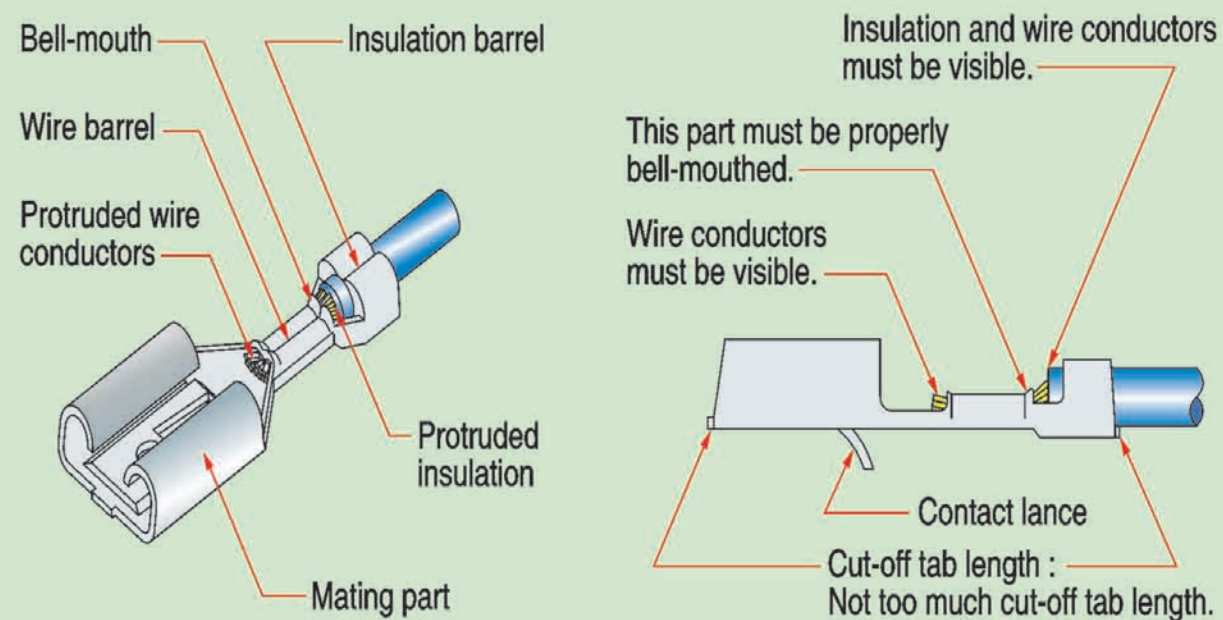

Cross section at crimped part

Wire barrel
Seam must be closed.



Insulation barrel
Wire must be securely held.



Crimp height measurement

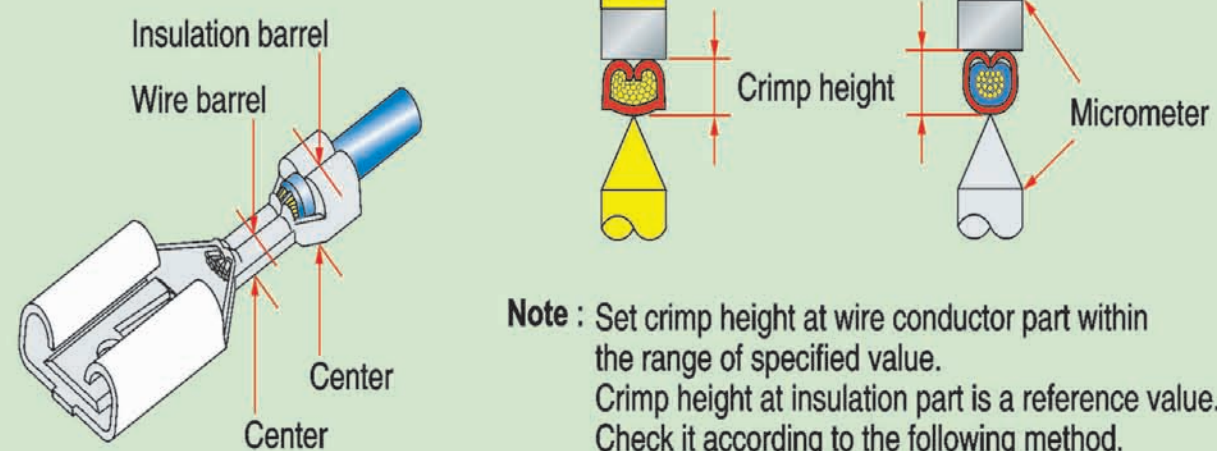

Check of insulation part

Cut off only wire insulation barrel, remove wire insulation and check wire conductors for damage.

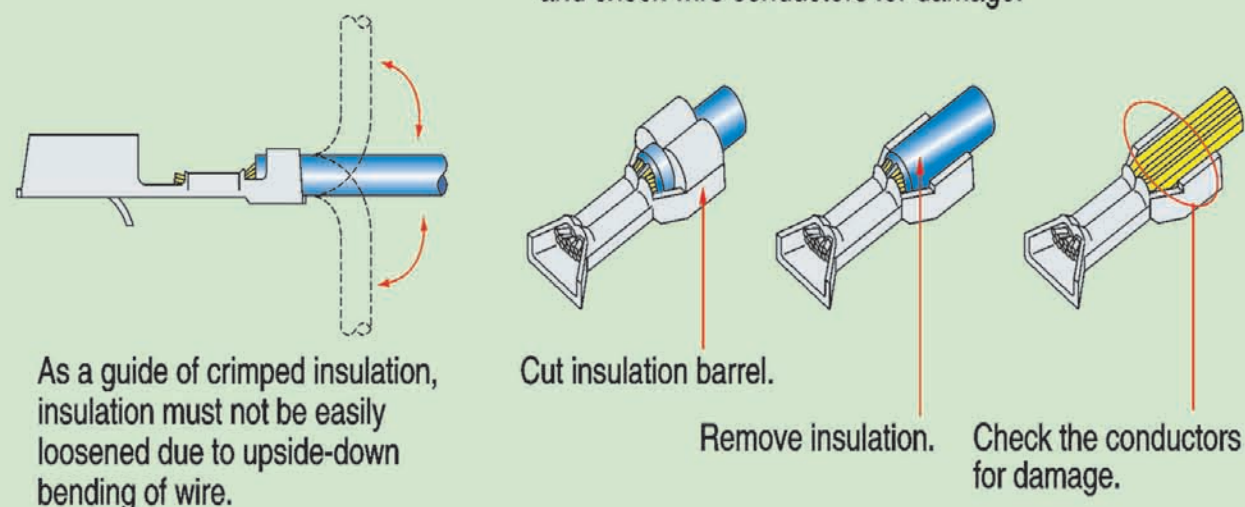

Incorrect crimping

Appearance defect

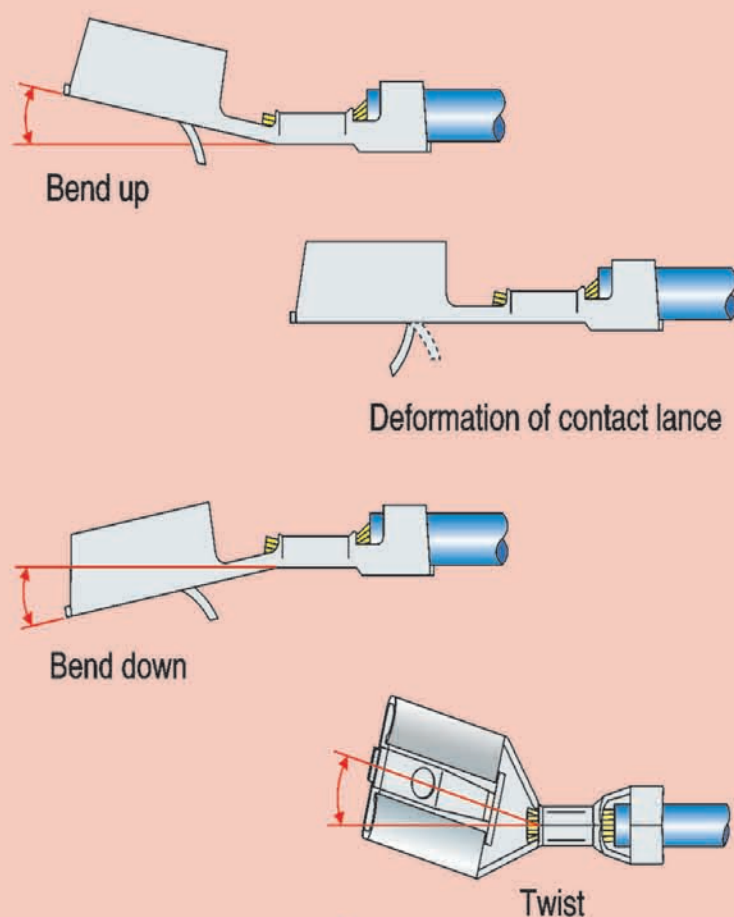

Cross section at crimped part of wire barrel

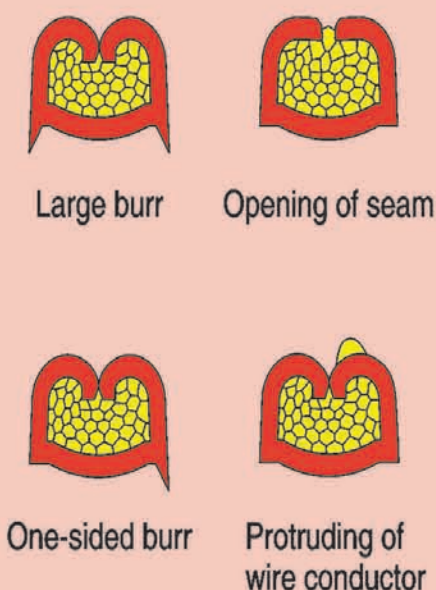

Cross section at crimped part of insulation barrel

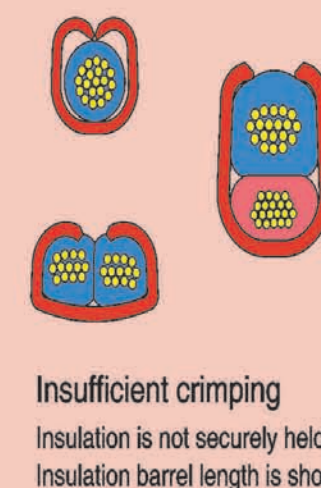

Bell-mouth

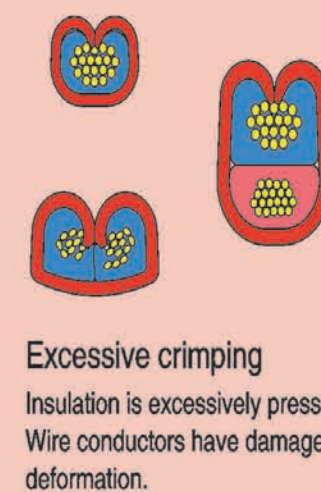
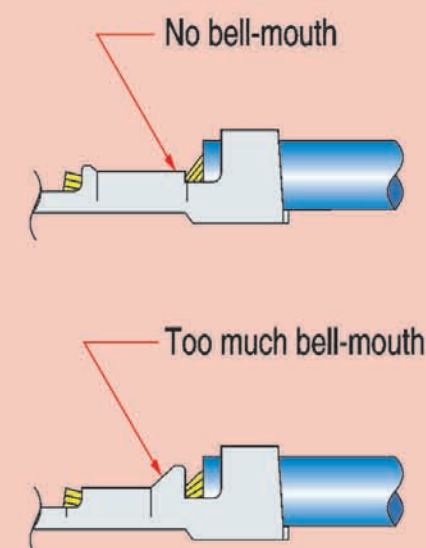
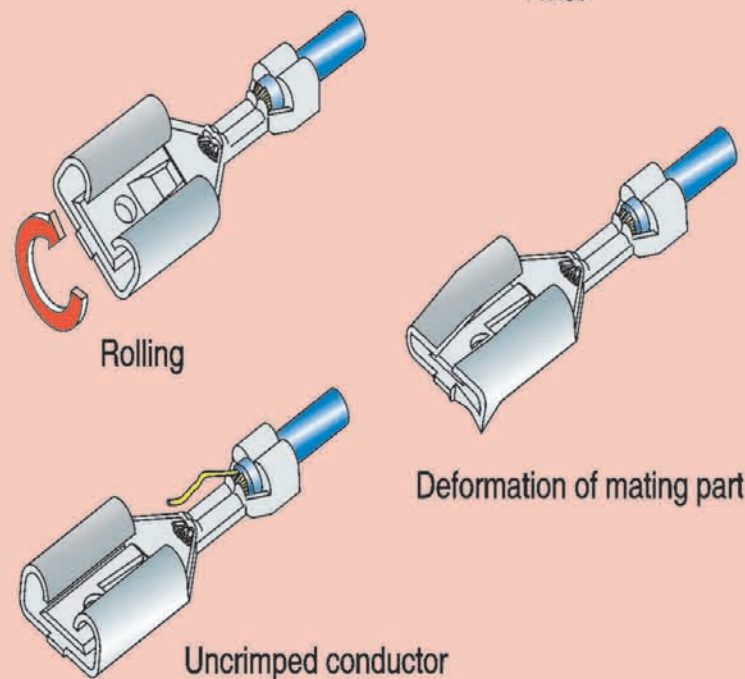

Wire conductors protruding length

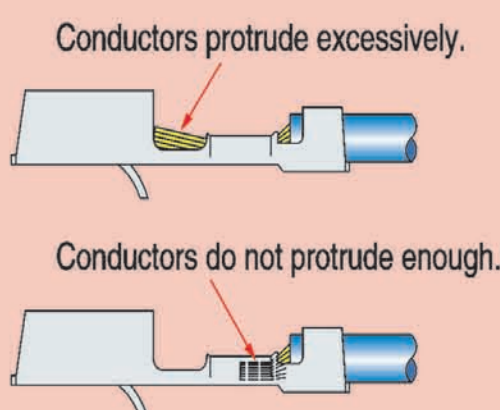

Wire insulation protruding length

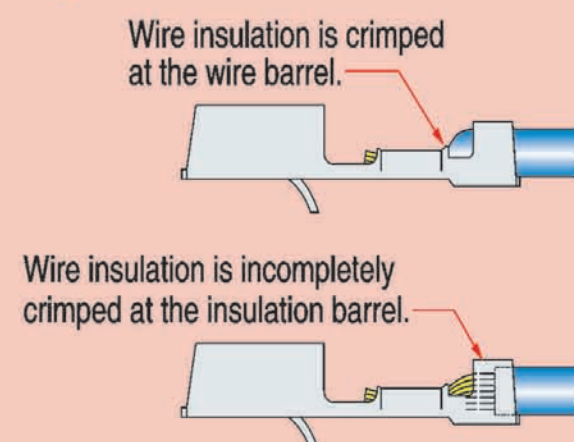

Cut-off tab length

